



TALLINN UNIVERSITY OF TECHNOLOGY

SCHOOL OF ENGINEERING

DEPARTMENT OF MATERIALS AND ENVIRONMENTAL TECHNOLOGY

# **EFFECT OF FIBRE CONTENT AND TYPE ON MECHANICAL PROPERTIES OF COMPRESSION- MOLDED COMPOSITE**

## **KIUDAINESISALDUSE JA TÜÜBI MÕJU PRESSVORMITUD KOMPOSIITMATERJALIDE MEHAANILISTELE OMADUSTELE**

MASTER THESIS

Student: Wasif Shabbir

Student code: 195999 KVEM

Supervisor: Dr. Elvira Tarasova, Senior Lecturer

Co supervisor: Dr. Illia Krasnou, Research Scientist

Tallinn 2021

(On the reverse side of title page)

## **AUTHOR'S DECLARATION**

Hereby I declare, that I have written this thesis independently.

No academic degree has been applied for based on this material. All works, major viewpoints and data of the other authors used in this thesis have been referenced.

"24" May 2021

Author: Wasif Shabbir

*/signature /*

Thesis is in accordance with terms and requirements

"24" May 2021

Supervisor: Dr. Elvira Tarasova

*/signature/*

Co Supervisor: Dr. Illia Krasnou

*/signature/*

Accepted for defence

"....." .....20... .

Chairman of theses defence commission: .....

*/name and signature/*

## **Non-exclusive Licence for Publication and Reproduction of Graduation Thesis<sup>1</sup>**

I, Wasif Shabbir (name of the author) (date of birth: 10/07/1986) hereby

1. grant Tallinn University of Technology (TalTech) a non-exclusive license for my thesis  
EFFECT OF FIBRE CONTENT AND TYPE ON MECHANICAL PROPERTIES OF  
COMPRESSION-MOLDED COMPOSITE

supervised by Dr. Elvira Tarasova, Dr. Illia krasnou.

1.1 reproduced for the purposes of preservation and electronic publication, incl. to be entered in the digital collection of TalTech library until expiry of the term of copyright;

1.2 published via the web of TalTech, incl. to be entered in the digital collection of TalTech library until expiry of the term of copyright.

1.3 I am aware that the author also retains the rights specified in clause 1 of this license.

2. I confirm that granting the non-exclusive license does not infringe third persons' intellectual property rights, the rights arising from the Personal Data Protection Act or rights arising from other legislation.

---

<sup>1</sup> *Non-exclusive Licence for Publication and Reproduction of Graduation Thesis is not valid during the validity period of restriction on access, except the university's right to reproduce the thesis only for preservation purposes.*

Wasif Shabbir

24 May 2021

**Department of Materials and Environmental Technology**

**THESIS TASK**

**Student:** Wasif Shabbir, 195999KVEM

**Study programme:** KVEM12/18, Technology of Wood, Plastic and Textiles

**main speciality:** Plastic

**Supervisor(s):** Senior Lecturer , Dr. Elvira Tarasova, +37258389514.

Research Scientist, Dr. Illia Krasnou, +37258389514.

Consultants: .....(name, position)

..... (company, phone, e-mail)

**Thesis topic:**

“ Effect of fiber content and type on mechanical properties of compression-molded composites.”

“ Kiudainesisalduse ja -tüübi mõju pressvormitud komposiitmaterjalide mehaanilistele omadustele.”

**Thesis main objectives:**

1. To produce organofiber-reinforced thermoplastic composites based on LDPE, Recycled LDPE, and Polypropylene by compression molding.
2. To study the effect of fiber content (10%, 30%, 40% and 50%) and type (cotton and PET) on flexural, tensile and charpy impact properties of produced composites.
3. To study the morphology of produced composites.
4. To study the effect of environmental impact (UV aging) on mechanical performance of composites.

**Thesis tasks and time schedule:**

No	Task description	Deadline
1.	compounding and compression molding of composites using PE, RePE and PP with PET, cotton and blend of PET +cotton fibres.	June 2020
2.	Flexural and tensile testing of produced composites.	Dec 2020
3.	Morphology, impact testing and tensile testing of UV effected samples to analyse effect of UV aging on composites.	Apr 2021

**Language:** English **Deadline for submission of thesis:** 24 May 2021

**Student:** Wasif Shabbir ".....".....20....a  
/signature/

**Supervisor:** Dr. Elvira Tarasova ".....".....20....a  
/signature/

Dr. Illia Krasnou ".....".....20....a  
/signature/

**Consultant:** ..... ".....".....20....a  
/signature/

**Head of study programme:** ..... ".....".....20....a  
/signature/

*Terms of thesis closed defence and/or restricted access conditions to be formulated on the reverse side*

## CONTENTS

PREFACE.....	8
List of Figures.....	9
List of Tables.....	11
List of abbreviations and symbols.....	12
1. INTRODUCTION.....	13
2. LITERATURE REVIEW .....	16
2.1 Composite materials.....	16
2.1.1 The polymer matrix composites (PMC).....	17
2.1.2 Fibre reinforced polymer composites.....	17
2.2 Polyester fibre as reinforcement or filler in polymer composites .....	20
2.3 Polyethylene as a polymer matrix in a composite.....	21
2.4 Polypropylene as a polymer matrix in a composite .....	21
2.4 Objectives of the research work .....	23
3. EXPERIMENTAL METHODOLOGY.....	24
3.1 Materials.....	24
3.2 Experimental design and procedure.....	25
3.2.1 Preparation of specimens .....	25
3.2.2 Molding of specimens .....	27
3.2.3 Cutting of specimens. ....	28
3.3 Testing of specimens.....	30
3.4 UV aging of composites.....	31
4. RESULTS AND DISCUSSIONS.....	32
4.1 Flexural properties of composites .....	32
4.1.1 Effect of fibre type and content.....	32
4.1.2 Effect of polymer type used as matrix .....	37
4.2 Tensile properties of composites .....	38
4.2.1 Effect of fibre type and content.....	39
4.1.2 Effect of polymer type used as matrix bending test.....	44
4.3 Impact test.....	45

4.4 Environmental impact on mechanical performance (tensile strength) of composite .....	46
CONCLUSIONS .....	48
SUMMARY .....	49
KOKKUVÕTE .....	51
REFERENCES.....	52

## **PREFACE**

First and foremost, I would like to express my gratitude to my supervisor, Senior Lecturer Dr. Elvira Tarasova, for her incredible support, encouragement, and sound advice during my thesis research. In fact, it was a great honour and opportunity for me to work under her supervision. I would like to express my gratefulness to my co-supervisor, Dr. Illia Krasnou, for his unwavering encouragement, helpful feedback, prompt availability, and assistance during the research project.

My heartfelt thankfulness to my family, friends and well-wishers for their exceptional support, encouragement and for all the unconditional love they have given me.

Cotton and polyester fibres are the main materials used in textile industry. Significant amounts of these fibers are consumed and discarded annually. The aim of this project is to utilize a new thermoplastics-based recycling technology for textile wasted fibres and recycled polymers to a prototype scale. The production of fibre reinforced thermoplastic composites at low cost, without using coupling agent and without losing physical and mechanical properties of composites is one of the outcomes of our project. In this study, composite compounds were made by incorporating PET, cotton, and blend of PET and cotton fibres with different fiber ratios into PE, RePE, and PP using a Brabender mixer. Afterwards, the compounded materials were processed via compression molding system to obtain bone shape samples. The influence of varying filler loads (10%, 30%, 40% and 50% weight content of fibers) and effect of UV on mechanical properties and their morphology is examined by different mechanical testing and SEM analysis. It was found that the flexural properties of PE and RePE composites are quite similar and are improved as compared to pure polymer matrix, but their tensile strength was dropped. These properties were declined significantly for PP composite with addition of fibres but improved its impact strength.

All of the study was conducted at Tallinn Technical University's Materials and Environmental Science Department under the supervision of senior lecturer Dr. Elvira Tarasova and research scientist Dr. Illia Krasnou.

**Keywords:** textile waste, polyester and cotton fibers, organofibres, fibre reinforced thermoplastic composites, compression molding.



## List of Figures

<b>Figure 1.</b> Classification of Composites based on (a) Matrix materials and (b) Reinforcement materials.....	17
<b>Figure 2.</b> Optical micrographs of virgin cotton fibres (a) and virgin PET fibres (d). SEM images of unmilled cotton (b), milled cotton (c), unmilled PET (e), milled PET (f).....	24
<b>Figure 3.</b> Compression molding machine .....	26
<b>Figure 4.</b> Dimensions (mm) of Test Specimen.....	28
<b>Figure 5.</b> Dumbbell shape specimens made up of PE with different fibres; (a) CF (b) PETf (c) CF+PET fibres. Fibre content in composites is different .....	28
<b>Figure 6.</b> Dumbbell shape specimens made up of RePE with different fibres; (a) CF (b) PETf (c) CF+PET fibres. Fibre content in composites is different .....	29
<b>Figure 7.</b> Dumbbell shape specimens made up of PP with different fibres; (a) CF (b) PETf (c) CF+PET fibres. Fibre content in composites is different .....	29
<b>Figure 8.</b> Steps of sample preparation.....	29
<b>Figure 9.</b> Schematic diagram of sample preparation for SEM analysis .....	31
<b>Figure 10a.</b> Dependence of flexural strength of PE-based composites on fiber loading .....	33
<b>Figure 10b.</b> Dependence of flexural modulus of PE-based composites on fiber loading .....	33
<b>Figure 11a.</b> Dependence of flexural strength of Re-PE based composites on fiber loading .....	34
<b>Figure 11b.</b> Dependence of flexural modulus of Re-PE-based composites on fiber loading.....	34
<b>Figure 12a.</b> Dependence of flexural strength of PP-based composites on fiber loading .....	35
<b>Figure 12b.</b> Dependence of flexural modulus of PP-based composites on fiber loading .....	35
<b>Figure 13.</b> SEM images of PP/CF composites with different CF content.....	36
<b>Figure 14.</b> SEM images of PP based composites filled with PETf, (CF+PETf), and CF. Fiber content is 10% .....	36
<b>Figure 15.</b> SEM images of (CF+PETf)-filled composites based on PE and PP. Fiber content is 40%. .....	37
<b>Figure 16.</b> Effect of matrix polymer type (PE, Re-PE and PP) on flexural properties of studied composites.....	38
<b>Figure 17.</b> Dependence of tensile strength of PE-based (a) and Re-PE-based (b) composites on fiber loading .....	39
<b>Figure 18.</b> SEM images of PE/PETf composites with different fiber loading (10-50%)	40

<b>Figure 19.</b> Effect of fiber content and type on tensile strain at break (presented in logarithmic scale) of PE-based (a) and RePE-based (b) composites .....	40
<b>Figure 20.</b> Effect of fiber content and type on tensile modulus of PE-based (a) and RePE-based (b) composites .....	41
<b>Figure 21.</b> SEM images of PE based composites filled with PETf, (CF+PETf), and CF. Fiber content is 10%. .....	41
<b>Figure 22.</b> DSC melting (right) traces of the PE/PETf-30 composite and its components, PE and PETf. ....	42
<b>Figure 23.</b> Dependence of tensile strength of PP-based composites on fiber loading	43
<b>Figure 24.</b> Dependence of tensile strain at break of PP-based composites on fiber loading. Inset demonstrates the effect of fiber content on tensile modulus .....	44
<b>Figure 25.</b> Effect of matrix polymer type (PE, Re-PE and PP) on tensile strength of studied composites. (a) Data are for PETf-filled composites; (b) Data are for (CF+PETf)-filled composites.....	45
<b>Figure 26.</b> Effect of matrix polymer type (PE, Re-PE and PP) on tensile strain at break (a) and tensile modulus for (CF+PETf)-filled composites. Fiber content is fixed at 30% .....	45
<b>Figure 27.</b> Comparison of Impact strength of Pure Polymer samples and its composite samples having different Fibers and their ratios.....	46
<b>Figure 28.</b> Tensile properties of PE-based composites with different fibers before and after UV treatment. Fiber content is 30%.....	47

## List of Tables

**Table 1.** Formulation for matrix polymers mixed with CF and PETf.....26

**Table 2.** Enthalpy of fusion for 70/30 PE/PETf composite obtained from melting thermogram .....43

## List of abbreviations and symbols

**PE** – Low Density Polyethylene

**RePE** – Recycled Low Density Polyethylene

**HDPE** – High Density Polyethylene

**PP** – Polypropylene

**CF** – Cotton fibre

**PETf** – PET fiber

**ASTM** – American Society for Testing and Materials

**μm** – Micrometer

**mm** – Millimeter

**MPa** – Megapascal

**ISO** – International Organization for Standardization

**PE** – Polyethylene

**PET** – Polyethylene terephthalate

**SEM** – Scanning electron microscopy

**UV** – Ultraviolet

# 1. INTRODUCTION

The role of composite materials in the twenty-first century cannot be overstated. Composites have long been the material of choice for low and high-performance structures due to unique inherent advantages like high specific mechanical properties. On comparing with the conventional materials such as alloys or metals, composite materials show high mechanical and tribological properties [1]. The original goal of developing composites was to improve the competitiveness of traditional materials whose strength and stiffness could not be developed by other means. From this standpoint, it is clear that the highest efficiency of a material's reinforcement is achieved by incorporating reinforcement elements into its structure. Fiber composites are primarily conceivable in the form of plastics (polymer) matrices reinforced with fibers, representing the most well-known group and marking the beginning of the industrial scale use of new materials [2].

The textiles industry employs millions of people around the world, making it one of the biggest and most important sectors of the manufacturing industry in Europe [3]. Europe is the world's second-largest exporter of textiles and apparel, after China [4]. Textile demand is increasing significantly across the world, according to Oerlikon (2010). Owing to population growth and economic development, this pattern is expected to continue [5]. The global textile market was estimated to be worth USD 1000.3 billion in 2020, and it is expected to rise at a CAGR of 4.4 percent from 2021 to 2028 [6]. According to (Sandin and Peters, 2018), as the market for clothing grows in parallel with population growth, so as a result of this the environmental impacts due to textile production, use, and disposal is also increasing [7].

Textile production and consumption, in reality, have substantial environmental, climate, and social consequences due to their use of energy, water, soil, and chemicals, as well as their emissions of greenhouse gases and pollutants [3]. The rise of fast fashion in the textile industry has resulted in a high level of waste generation as a result of excessive garment use and disposal. As a result, landfills receive millions of tons of textile waste per year [8].

Plastic has been a common part of human life since its mass manufacturing began in the 1940s. Plastic production worldwide increased to nearly 360 million metric tons in 2018. Plastic demand is predicted to triple by 2050, accounting for a fifth of all global oil consumption [9]. With the unique properties of plastics such as ease of manufacturing and shaping, low cost, and low density, it is the most widely used man-

made material on the planet. It is extremely useful in a variety of fields, including medicine, architecture, building, and transportation [10].

The plastics industry is a vital component of Estonia's manufacturing sector. According to Statista Research Department, the turnover of this sector was around 417 million euros in 2018. This was a significant improvement from the previous year, and it was the highest turnover during the period under consideration [11].

Though, the same features that make plastics so appealing also make them so common in the environment. In response to mounting pressure to combat pollution, global warming, and climate change, the world is increasingly shifting towards a circular economy. As a result, the manufacturing industries of textiles and plastics are under increasing pressure to reduce carbon emissions and create a sustainable value chain for raw material supply, while at the same time meeting the demands of increased competition [12]. Finding innovations to fill the technological gaps and bringing these new innovations to market fast enough are some of the biggest challenges for both industrialists. Disposal of textile waste can be managed effectively by using it with polymers to produce composites. This concern has driven scientists all over the world to develop environmentally sustainable materials and manufacturing processes [12]. One common way to tackle environmental concern is the recycling of textile waste, some of the most common techniques of textile recycling are either chemical, mechanical less frequent thermal [13]. For a long time, composites have been used to address engineering problems. This is especially true when polymer materials in the form of fibres are combined with resin to form a polymer composite [14].

Due to substantial improvements in structural, mechanical, and tribological properties of fiber-reinforced composite (FRC) material. Composites have been proposed as an alternative to many traditional materials in research studies over the last two decades [12]. FRP composites are light weight, non-corrosive, simple to manufacture, have high stiffness and specific strength and can be adapted to meet specific performance requirements [15]. Composite materials have turn out to be as one of the materials with such improved qualities, allowing them to be used in a wide range of applications. [12].

In today's dynamic textile and plastic industry, market demands lighter, stronger, and safer products. Many of these requirements can be achieved by using fiber reinforced composites. They have distinct advantages over conventional materials, like stiffness, high strength, low density, fatigue life, and which enable them to be used in a wide range of applications [16].

The use of synthetic or natural fibers in the manufacturing of composite materials has found in different fields including aerospace, building, automotive, biomedical, mechanical and marine engineering [12]. By increasing the reuse and recycling of plastic and textile waste can reduce the production of virgin raw material and avoid manufacturing processes which means a significant reduction in environmental impact [13].

The objective of this research work is to produce Polymer Fibre composites material by utilizing textile waste (Cotton and PET fibres) with thermoplastic polymer matrix (PE, Recycled PE and PP) and this approach will help in reducing the proportion of textile and plastic waste into incineration or landfilling. In the first phase, polymer matrix is mixed with textile fibres having different fibre ratios (10%, 30% 40% and 50%) to produce compounding material and then converting them into flat shapes by pressing. In second phase, these compounds are transformed into final bone shape specimen with the help of compression molding technique. In final stage, the mechanical properties and morphology of produced samples were tested.

## **2. LITERATURE REVIEW**

This chapter presents a detailed literature survey to gain an overview of polyester and cotton fiber filled polymer composites. As a part of the research project, their production procedures, and mechanical testing methods are reviewed. The potential applications of cotton and polyester fiber reinforced composites are also addressed in the last section of this chapter. Based on the previous and current research work, PE and PP materials are analysed and discussed as a composite matrix material.

### **2.1 Composite materials**

A composite is made up of two or more constituents that are insoluble in one another. The reinforcing phase is one of the components, and the matrix phase is the one in which it is embedded [17]. The reinforcing phase is tougher than the matrix phase and comes in the form of particles, fibers, or flakes. The matrix phase materials are ductile and continuous in nature [17]. The content of composite materials is divided into two categories: base material and filler material. The filler material is present in the form of sheets, fragments, particles, fibers, or whiskers of natural or synthetic material, and the matrix or binder material attaches or retains the filler material in structures [12]. Materials with high strength, stiffness, and low thermal expansions are embedded in the matrix reinforcement. As the matrix carries the applied load to the material, the reinforcement process in composites is normally stronger and stiffer than the matrix. As compared to the properties of individual materials, this improvement makes composite materials superior [18]. There are three types of composite materials that are commonly used in a variety of engineering applications, metal–matrix composites, polymer–matrix composites and ceramic–matrix composites as shown in Figure 1. Based on the reinforcement type, composite materials can be categorized into fibre-reinforced composites, particulate composites and structural composites.



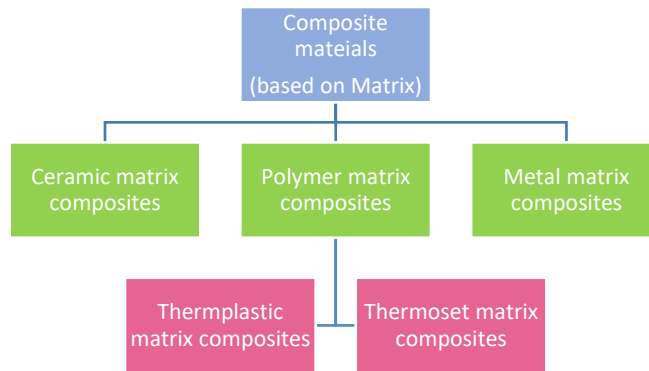

(a) Based on matrix materials

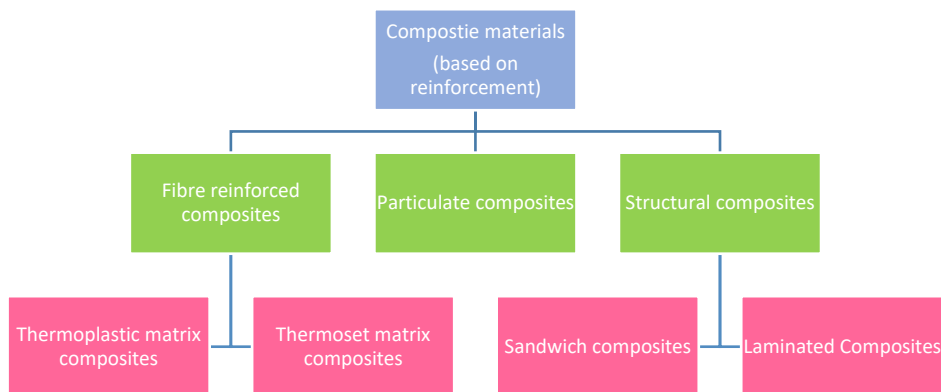

(b) based on reinforcement materials.

**Figure 1.** Classification of Composites based on (a) Matrix materials and (b) Reinforcement materials [19].

Due to their broad range of diverse properties, composite materials have found applications in construction, mechanical, aerospace, biomedical, automobile, marine, and several other manufacturing industries [12].

### 2.1.1 The polymer matrix composites (PMC)

Polymers are increasingly used in engineering applications due to their excellent chemical resistance, good mechanical properties, and lower cost. One major disadvantage of such polymers is that they are nonbiodegradable after use, which can be mitigated to some degree by combining polymers with natural fibers in composite materials. As matrix materials in composite preparation, both thermoplastics and thermosets have advantages and disadvantages [20].

### 2.1.2 Fibre reinforced polymer composites

The development of new advanced types of Fibre-reinforced polymer (FRP) materials has been a major factor driving the increased use of composites in recent years. Fibre-

reinforced polymer also known as Fibre-reinforced plastic, is a composite material composed of a polymer matrix reinforced with fibers [15]. A matrix is a vital component of fibre-reinforced composite. It protects the surface of the fibres from mechanical abrasion and ensures cohesion and orientation of the load to fibres by providing a barrier against harsh environment [20],[21],[22].

Fiber-reinforced polymer composites not only have a high strength-to-weight ratio, but they also have unique properties like high durability, flexibility during processing, low self-weight, low cost, damping property, stiffness, flexural strength, and resistance to corrosion [23].

Carbon, glass, or aramid fibers are commonly used in FRP composites, but other fibers such as paper, wood, or asbestos have also been used. However, both of these types of fibers have benefits and drawbacks. The mechanical properties of synthetic fiber-reinforced thermoplastic composites are superior to natural fibers, but they are not ecofriendly [15], [24].

In recent years, the constant increase of the environmental awareness reflected on the need and attempt to replace synthetic materials by materials with less environmental impact and damage, such as natural fibers. The constant rise in environmental concern in recent years has reflected the need for and attempt to substitute synthetic materials with resources that have less impact on the environment, such as natural fibers [25].

**Natural Fibre reinforced polymer composites** materials are generating a lot of interest, both in terms of industrial applications and fundamental research [26]. A polymer matrix reinforced with natural fibers has a higher resistance, and the interfacial bonding between them keeps their chemical and mechanical identities intact [20].

Since polymeric matrices are light, and due to the possibility of treating them at low temperatures, they are most widely used in natural fibre composites. Both thermoplastic and thermoset polymers have been used in natural fiber matrices [21] for example; phenolics and epoxies, unsaturated polyesters, and polyethylenes, polypropylenes, and elastomers, are generally used in the composites industry [27].

The use of natural fibers like cotton, sisal or flax [28] are, reusable, biodegradable in nature and readily available [29], therefore natural fiber reinforced polymer composites (NFRC) is one such area where traditional synthetic fibers like carbon and glass are being replaced by natural fiber. In this area, significant progress has been made, and a decent number of review papers are published [30]. Faruk et al examined all the developments that occurred between 2000 to 2010, they explained about different

natural fibers, their availability, methods of treatment and about several polymer matrix that had been used [31]. The factors that are important for the performance of natural fiber reinforced polymer composites are overviewed by Pickering et al. [21]. A comprehensive overview about the use of polymers for various natural fiber composites is given by T.G. Yashas Gowda [20]. In recent years, several forms of natural fibers have been investigated for usage in composites, like hemp, straw, jute, flax, barley, wheat, oats, cane (Sugar and bamboo), grass, kenaf, reeds etc [32]. The desired combination of properties expected use, and manufacturing process all influence the filler as well as matrix material selection [16].

Natural (plant) fibers have a number of weaknesses over synthetic fibers, a wide range of lengths including non-uniformity, and mechanical properties (even between individual natural fibers in the same cultivation) [33] and have poor property of resistance to moisture absorption [23][29].

In comparison to synthetic fibers, natural fibers have lower strength properties [23], [27] [32]. However, the specific modulus and elongation at break shows the capability of natural fibres to substitute synthetic fibres in engineering polymer composite [23], [27].

**Cotton Fibre as reinforcement or filler in polymer composites** Cotton fiber is one of the most effective textile fibers, with a cellulose content of 90–93%. In these fibers, cellulose is viewed as a spiral of long chains of molecules linked together by hydrogen bonds. The fiber gains high tensile strength and dimensional stability as a result of this arrangement. Cotton fibers have a low density relative to fiberglass (1.54 g cm<sup>3</sup> vs. 2.6 g cm<sup>3</sup>), high crystallinity, and high impact resistance compared to synthetic fibers [25]. Cotton fibers can be generated from textile industry waste cotton fabrics. Various methods and studies were carried out in order to take use of waste cotton fibres [34]. While there are many benefits of using cotton fibers in composites, the key problem that needs to be addressed is the composites' poor mechanical properties. Many chemical or physical methods are being investigated for this purpose, including corona treatment, plasma treatment, alkaline treatment, acetylation treatment, silane treatment, enzyme treatment, and coupling agent use, among others [29], [34], [35].

Since the chemical compositions of both the fibres and the matrix are different, combining natural fibers and polymers was considered a challenge. These are some of the reasons for the unsuccessful stress transfer at the composites' interface. As a result, natural fiber modifications using specific treatments are unquestionably needed [36].

In a study of chemical treatments of natural fibers, Kabir et. al [27] was agreed that treatment is a vital element to take into consideration when processing natural fibers. According to A. Mohd [36], the proportion of polymer waste used in manufacturing with natural fiber is expected to increase over time, therefore problems regarding recycling should be tackled. It concluded that chemically treated natural fibres strengthened the adhesion between the fibre surface and the polymer matrix, which enhanced the properties of natural fibres embedded composites over time [36].

In order to find out the possibility of using cotton fabric (CF) as reinforcement in the thermoplastic polymer matrix, W K. Rukmini [37] produced cotton fabric reinforced polypropylene (PP) composites by the compression molding of polypropylene sheets with 20% and 30 weight% of cotton fabric. It was evaluated that as the cotton fabric content increased in the PP matrix, the mechanical properties like tensile strength, flexural strength, tensile modulus, and flexural modulus has also increased, whereas the tensile elongations decreased. [37].

## **2.2 Polyester fibre as reinforcement or filler in polymer composites**

One of the most important fibers used in industrial production is PET (polyethylene terephthalate). Due to its high performance, recyclability, and low cost, it is known as one of the most desirable candidates for high strength fibers [38].

Blending PP with PET is a reasonable and effective way to enhance PP properties. Polypropylene (PP) has sufficient tensile strength for common textile and technological applications. However, the key disadvantage of PP is that it has a low Young's modulus and has poor recovery properties. On the other hand, PET, due to its high strength and modulus, it has been commonly used in a variety of applications [39].

Polypropylene composites containing short, recycled PET (rPET) fibers are potential sustainable materials, but there are still few works in this area and mostly using less than 10 weight% recycled PET in the matrix [40]. M.A. LoÁpez-Manchado, M. Arroyo researched that If PET fibres are added in PP/elastomer blend, then the fibres works effectively as a reinforcing agent, due to which tensile and flexural properties are increased, especially at high copolymer levels. In addition, they also showed that mechanical properties of the composite is improved by matrix fiber interface adhesion [41]. There is another research work done by M.A. Lopez-Manchado and M. Arroyo [42]; it was the study regarding the effect of integrating short PET fibers (6 mm) having 20

weight% with and without coupling agent in PP composites, produced by calendaring with compression molding. Mechanical properties of PP has shown that fibers may act as nucleating agents and increases the stiffness of polypropylene [42].

Another study was conducted by Palova SantosSérgio Henrique Pezzin [43], in which PET fibres having length of 5mm from recycled poly ethylene terephthalate (PET) were incorporated into polypropylene. PP/PET composites containing 3, 5, and 7% PET fibres were produced with the help of monoscrew extrusion and using injection molding. They concluded that including these fibers in PP can be a cost-effective way to recycle PET while also greatly improving the impact properties of PP [43].

### **2.3 Polyethylene as a polymer matrix in a composite**

The benefits of using PE as a thermoplastic matrix were investigated by making PE-maize fiber composites. The thermal and mechanical properties of this material were reasonable. Besides that, the use of maize fibers as HDPE reinforcements resulted in maize fibres' preference for HDPE, as well as a reduction in thermal conductivity and thermal diffusivity as the fiber content increased [20].

(Youssef, Ismail, Ali, & Zahran, 2009) [44], reported the effect of the thermoplastic/baggase fiber ratio on the physical and mechanical properties of high-density polyethylene (HDPE) and low-density polyethylene (LDPE) composites. Study showed that the mechanical and physical properties of both LDPE and HDPE composites deteriorated significantly as the bagasse fiber content in both increased to 50%. [44], [20]. The study of Processing and characterization of polyethylene-based composites were reviewed by P. Noorunnisa Khanam & Mariam Al Ali Al Maadeed. They found that, in order to make new composites with PE as a matrix and fiber/filler additive, a variety of procedures can be used. Extrusion, hot pressing, and injection molding are some of the examples. The addition of the fiber/filler will increase mechanical properties such as hardness and tensile strength. Coupling agents are recommended to enhance the properties of the fiber/matrix interface [45].

### **2.4 Polypropylene as a polymer matrix in a composite**

Polypropylene is indeed one of the most commonly used thermoplastic polymers because of its moderate to excellent mechanical properties. As a result, it is an obvious alternative for the matrix material in natural fiber-reinforced composites [20]. Most of the other benefits is that its properties can be improved by fillers, fibers, and elastomers

to enhance stiffness, resilience, dimensional stability, and impact resistance [46]. Polypropylene (PP) composites have excellent flowability, mechanical characteristics, chemical resistance, weatherability and are economical considering cost aspects [47]. Due to its high strength to weight ratio, it is commonly used in automotive, furniture, electrical appliances, household and packaging applications. [48]. High-performance PP composites with superior physical properties have finally been developed after several years of accumulating various technologies for improving PP composites. [47]. It is necessary to remember that the output of PP composites is influenced not only by their inherent properties but also by the processing conditions. PP is therefore highly susceptible to flaws introduced during the manufacturing process. In the case of composites, these flaws are much more noticeable [49].

Several studies have been published on the use of various types of fibers to strengthen polypropylene (PP) and other thermoplastic polymers in order to increase tensile modulus [40],[50], [51]. Among the various fibers used in PP composites, glass fibers are the most common [24] ,[51].

The effect of fiber content on the mechanical properties of polymer composites is especially fascinating and crucial. Increases in fibre content have been shown to improve strength and modulus [43]. The effect of particulate fillers on PP resin has already been studied extensively. It has long been known that as filler loading increases, stiffness-related properties increase while flexibility-related properties decrease [52].

Siti Nadia Mohd Bakhori [53] in their research work found that the amount of fiber in a composite laminate has a big impact on its mechanical properties. In general, increasing the amount of fibre loading until it reaches an optimal value increases the tensile strength and Young's Modulus. Nevertheless, when the quantity of fibre was increased beyond the optimum (60 % of the fibre contents), the strength of the jute-PP composite laminates reduced, owing to an abundance of fibres causing ineffective load transfer from the matrix to the fibre in the composite system [53].

A study by Nam-Jeong Lee, Jyongsik Jang [54], the effect of fiber content on the mechanical properties of glass fibre mat/polypropylene composites revealed that the tensile and flexural modulus increased as the glass fibre content increased. Whereas the tensile and flexural strengths hit their maximum values and then started to decline as the glass fibre content increased after the optimum value [54].

## **2.4 Objectives of the research work**

The aim of the study is an investigation of mechanical properties of cost effective organofiber filled thermoplastic composites produced by compression molding.

To achieve the goal of the work the following tasks should be solved:

- To produce organofiber-reinforced thermoplastic composites based on LDPE, Recycled LDPE, and Polypropylene by compression molding.
- To study the effect of fiber content (10%, 30%, 40% and 50%) and type (cotton and PET) on flexural, tensile and Charpy impact properties of produced composites.
- To study the morphology of produced composites.
- To study the effect of environmental impact (UV aging) on mechanical performance of composites.

### 3. EXPERIMENTAL METHODOLOGY

#### 3.1 Materials

The used material can be separated into two types: the matrix materials and the fiber materials. The matrix materials are represented with three types, these are Low Density Polyethylene (PE), recycled Low Density Polyethylene (RePE) and polypropylene (PP). The fiber materials are the cotton fiber (CF) and PET fiber (fPET), which were used as a reinforcing material. Mixture of 50/50 CF/fPET was also tested as a reinforcing agent. The PP was purchased from the Eggeuroptene and has a melt flow index specified according to ASTM D 1238 as 1.4 g/10 min. PE was purchased from Eggeuroptene and its melt flow index is 5 g/10 min, while RePE was obtained from Frog PlastFrog OÜ and its melt flow index is 5 g/10 min.

The CF used in the work was supplied by Lemonia Estonia OÜ (Tallinn, Estonia). CF was dried at 70°C under vacuum of 50 bars for overnight, picked (seedless), and carded (i.e., pure cotton). It is worth stating that as the used cotton was dried, the moisture content was negligible. A Retsch cutting/milling machine was used to cut the cotton into very fine sizes. The size of the sieve was 12 mm. CF had an average length of 15µm and a diameter 16mm. The physical appearance of cotton fibers is depicted in Figure 2.

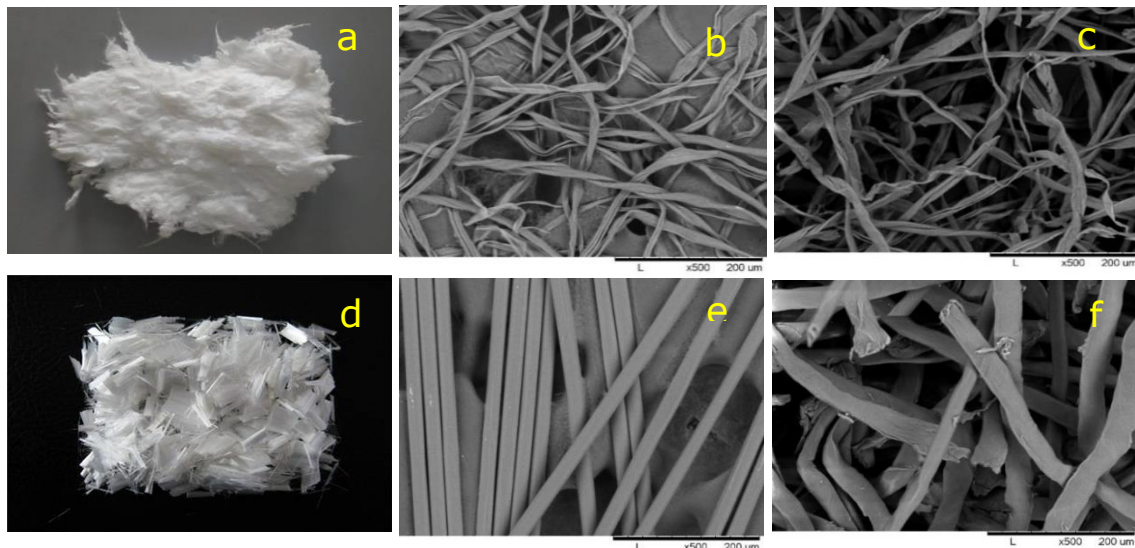

**Figure 2.** Optical micrographs of virgin cotton fibres (a) and virgin PET fibres (d). SEM images of unmilled cotton (b), milled cotton (c), unmilled PET (e), milled PET (f).

The PETf used in the work was supplied by Advansa GmbH (Hamm, Germany). A Retsch cutting/milling machine was used to cut the PETf. The size of the sieve used was 2 mm.



PETf had an average length of 30 $\mu$ m and a diameter 12 $\mu$ m. The PETf had a density of 6.7 dtex. The physical appearance of PET fibers is depicted in Figure 2.

The Scanning electron micrographs (SEM) images of cotton and polyester fiber samples are shown in the figure 2. CFs are flat and twisted, while polyester fibers are completely round and straight. By comparing cotton and polyester fibers, polyester fibres have more regular shapes and invariable diameters and also these are thicker than cotton fibres. The average fibre thickness of PET fibres is 28.9  $\mu$ m whereas for cotton it is 12.7  $\mu$ m.

## **3.2 Experimental design and procedure**

Herein, the orders of samples preparation and the step by step procedure to make the experiments are described in detail.

### **3.2.1 Preparation of specimens**

As a reference material, specimens from pure PE, PP, and RePE without any addition of fibres in were produced. Afterwards, composite samples were produced by mixing the polymer matrix (PE, PP, RePE) with different fibres (cotton, polyester, and their 50/50 blend). The required quantities of these materials for mixing were dependent on the mixing capacity of Brabender Mixer. As in our case, it tend to mix 36 grams of material at once. So, individual calculation for the amount of polymer matrix and fibers were calculated. The content of fibres in composites was 10%, 30%, 40%, and 50%. The CF, PETf, PE, RePE and PP mixtures were composed according to the formulation specified in Table 1.

**Table 1.** Formulation for matrix polymers mixed with CF and PETf

Material	Sample abbr.	Composite Composition in %		Required quantities for mixing in grams	
		Polymer	Fibre	Polymer	Fibre
PE	PE	100	0	36	0
PE/CF	PE/CF-10	90	10	32.4	3.6
	PE/CF-30	70	30	25.2	10.8
	PE/CF-40	60	40	21.6	14.4
	PE/CF-50	50	50	18	18
PE/PETf	PE/PETf-10	90	10	32.4	3.6
	PE/PETf-30	70	30	25.2	10.8
	PE/PETf-40	60	40	21.6	14.4
	PE/PETf-50	50	50	18	18
PE/(CF+PETf)	PE/(CF+PETf)-10	90	10	32.4	3.6
	PE/(CF+PETf)-30	70	30	25.2	10.8
	PE/(CF+PETf)-40	60	40	21.6	14.4
	PE/(CF+PETf)-50	50	50	18	18
RePE	RePE	100	-	36	-
RePE/CF	RePE/CF-10	90	10	32.4	3.6
	RePE/CF-30	70	30	25.2	10.8
	RePE/CF-40	60	40	21.6	14.4
	RePE/CF-50	50	50	18	18
RePE/PETf	RePE/PETf-10	90	10	32.4	3.6
	RePE/PETf-30	70	30	25.2	10.8
	RePE/PETf-40	60	40	21.6	14.4
	RePE/PETf-50	50	50	18	18
RePE/(CF+PETf)	RePE/(CF+PETf)-10	90	10	32.4	3.6
	RePE/(CF+PETf)-30	70	30	25.2	10.8
	RePE/(CF+PETf)-40	60	40	21.6	14.4
	RePE/(CF+PETf)-50	50	50	18	18
PP	PP	100	-	36	-
PP/CF	PP/CF-10	90	10	32.4	3.6
	PP/CF-30	70	30	25.2	10.8
	PP/CF-40	60	40	21.6	14.4
	PP/CF-50	50	50	18	18
PP/PETf	PP/PETf-10	90	10	32.4	3.6
	PP/PETf-30	70	30	25.2	10.8
	PP/PETf-40	60	40	21.6	14.4
	PP/PETf-50	50	50	18	18
PP/(CF+PETf)	PP/(CF+PETf)-10	90	10	32.4	3.6
	PP/(CF+PETf)-30	70	30	25.2	10.8
	PP/(CF+PETf)-40	60	40	21.6	14.4
	PP/(CF+PETf)-50	50	50	18	18

### 3.2.2 Molding of specimens

Once the materials were accurately calculated than they were introduced to Brabender Mixer. The function of this machine was to melt the polymer matrix and then add fibre reinforcement to form a homogenous mixture.

Following steps of compression molding have taken place:

- Preheating of a machine nearly 10 to 15 minutes at temperature 160°C for PE and RePE, whereas 180°C for PP.
- The time of preheating was not fixed, because when required temperature is achieved, the weighted polymer was filled inside the mixing chamber with the use of the funnel tube. Then, the matrix was left to melt for 5-8 min until it melted and formed a viscous material.
- Once the polymer material was melted completely, the weighted CF or PETf was gradually added into the mixing chamber together with the melted polymer. Blending was done for 5-8 minutes to attain a homogenous mixture.
- When the mixing material became completely homogenous, the machine was stopped.
- The composite compounds obtained from melt blending were then pre-molded into 4 mm thick square plates under a pressure of 50 bars at 100°C for 5 min.



**Figure 3.** Compression molding machine

In order to produce a final shape of composites' samples, following procedure took place.

- Preheating of compression molding machine (S.C.A.M.I.A. ARTFORTVILLE 94140 FRANCE) shown in Figure 3 and molds having a rectangular shape of size 15x8

cm to a temperature of 160°C for PE based composite and 180°C for PP based composite.

- Pre-molded samples were put into the heated mold and pressed at pressure of 50 bar during 2-3 min. Afterwards, pressure was increased to 100 bar for approximately 5 minutes.
- The molded specimen is then treated with cold water for cooling. The temperature of water was nearly 12-15°C.
- It is worth noting that the aim of this work was to produce cost-effective, CF and PETf-reinforced thermoplastic composites. Therefore, neither coupling agents nor a compatibilizer was permitted.

### 3.2.3 Cutting of specimens.

Dumbbell-shaped test specimens were cut out from produced sheets, see Figure 5, 6 and 7. The specimen has a standard shape and size which is (150 × 10 × 4) mm, as shown in figure 4. The dimensions of these samples are defined in ISO 572-2 standard.

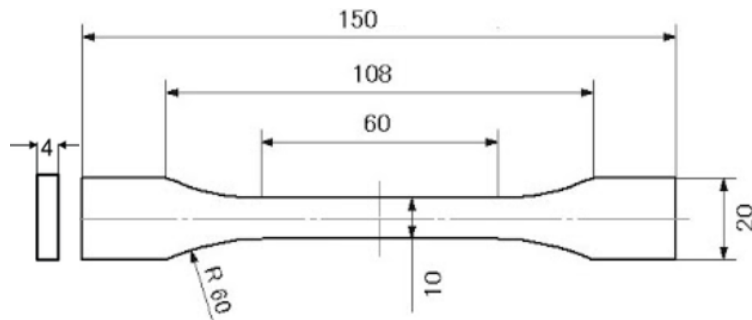

**Figure 4.** Dimensions (mm) of test s pecimen

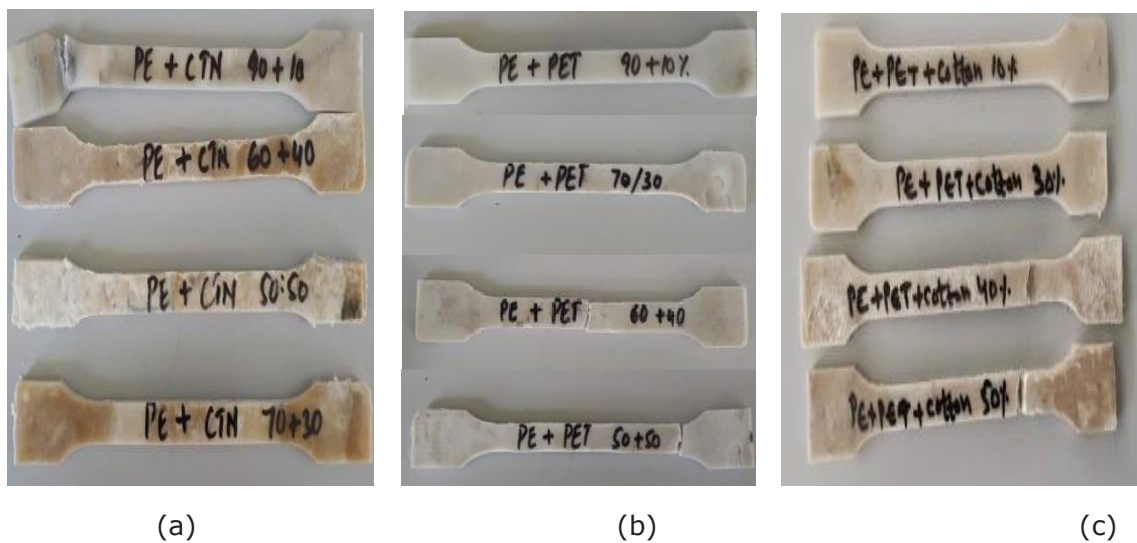

**Figure 5.** Dumbbell shape specimens made up of PE with different fibres; (a) CF (b) PETf (c) CF+PET fibres. Fibre content in composites is different.

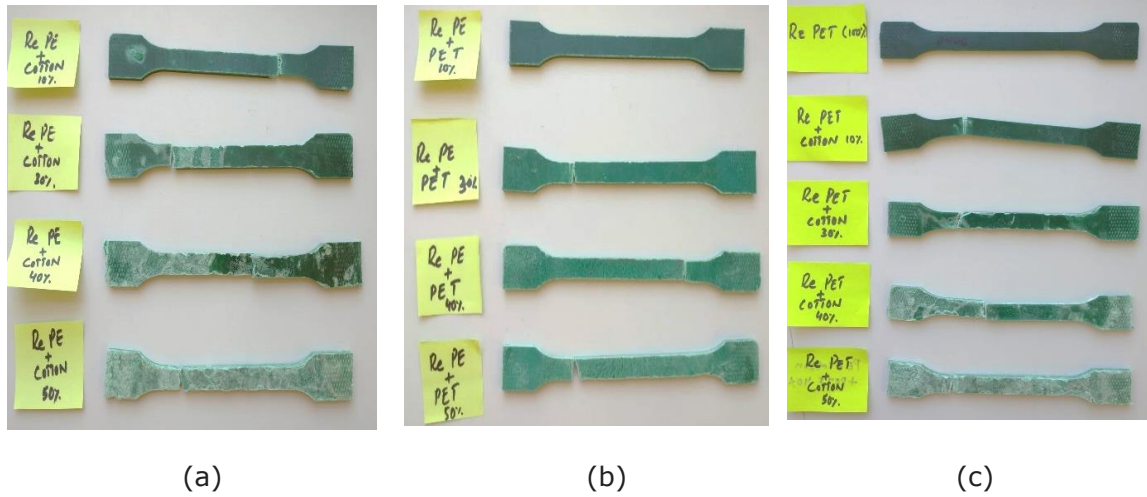

**Figure 6.** Dumbbell shape specimens made up of RePE with different fibres; (a) CF (b) PETf (c) CF+PET fibres. Fibre content in composites is different.

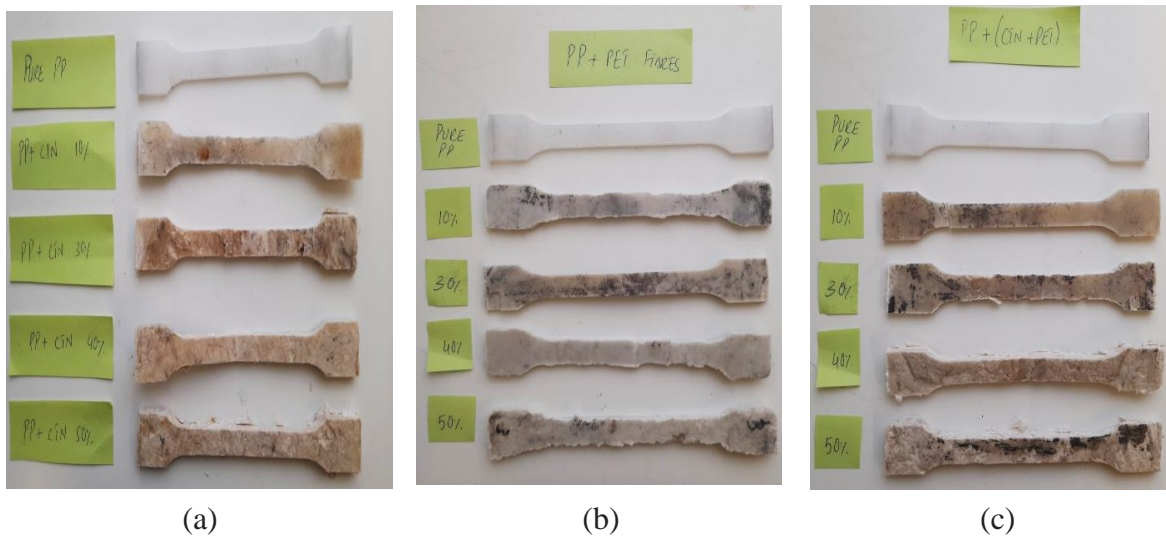

**Figure 7.** Dumbbell shape specimens made up of PP with different fibres; (a) CF (b) PETf (c) CF+PET fibres. Fibre content in composites is different.

General work flow of sample preparation is demonstrated in Figure 8.



**Figure 8.** Steps of sample preparation.

### 3.3 Testing of specimens

Tensile and flexural tests were carried out on INSTRON 5866 universal testing machine, using a load cell of 10 kN and was performed according to ASTM D790 and ISO 178. The crosshead speed was set to 2 mm/min. For tensile test the grip distance was set to 11 cm. In order to perform the flexural test, moulded samples were cut into rectangular shapes. The size of the specimen was (100 × 10 × 4) mm. In total, 5 test specimens were used both for the tensile and flexural test and the average of these results was taken as the resultant value. The data was collected and the curves for individual specimen were created automatically using a Blue Hill software.

As, tensile testing determines a material's ability to resist forces that tear the sample apart, as well as how far it can stretch until splitting. Therefore, the main objective of the tensile tests was to see how fibre content affected tensile strength and modulus of elasticity.

Charpy impact strength testing was conducted to check the impact strength of the composites with respect to fibre content. Charpy impact test was performed according to ISO 179 using a Zwick 5102 pendulum impact tester. In order to perform the test, specimens were first notched in V shape, notched depth was 2 mm and width was 8 mm. Afterwards, notched samples was mounted carefully on the supporting blocks in a horizontal position. The setting of notched specimen was in such a manner that when pendulum moved, it hits the centre of the specimen's notched area. The impact energy absorbed by the specimen was measured on the screen of the impact tester for five samples. The following formula was used to measure Charpy impact strength.

$$acN = \frac{W}{h \times bN} \times 10^3 \quad 3.1$$

Where:

$acN$  = Impact strength (KJ/m<sup>2</sup>)

$W$  = Energy (J) absorbed by the test sample

$bN$  = Width at the notch base of the test sample- i.e., 8 mm

$h$  = Thickness of the test specimen (mm) - i.e., 4 mm

In order to study the morphological structures of composites, specimens that were taken from the fractured surfaces have been examined using an optical and scanning electron microscope.

Using a scanning electron microscope (SEM), the failure phenomenon and forms of damage progression on composite were investigated. Using SEM analysis technique,

we learn more about crack propagation, fiber–matrix bonding, and fibre distribution. For this reason, pure polymer matrix (PE and PP), as well as composite made up of these matrices with textile fibres (Cotton, PET, and their blend) was evaluated. The HITACHI TM-1000 Tabletop SEM was used in this experiment. The cross-sectional area of the samples was examined.

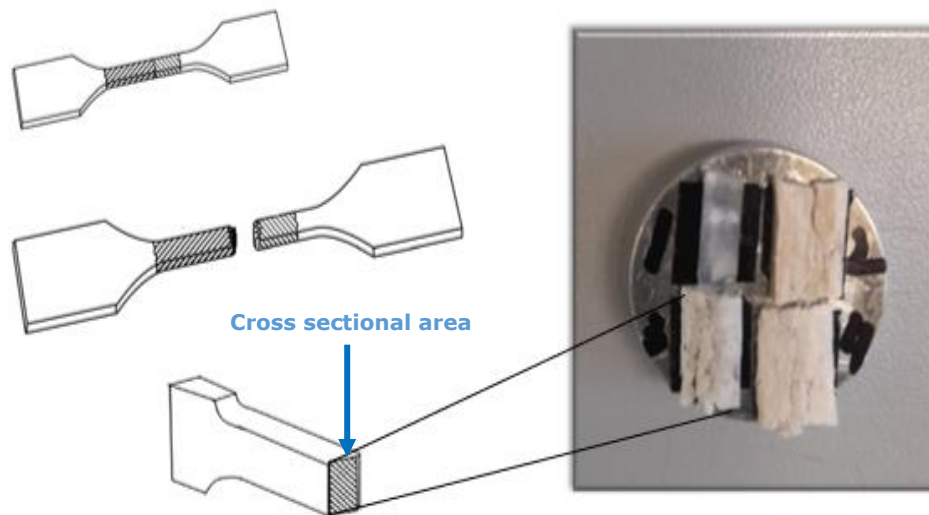

**Figure 9.** Schematic diagram of sample preparation for SEM analysis

### 3.4 UV aging of composites

Analysing polymeric composites' mechanical properties after UV radiation imitating real climate conditions is vital. For this purpose, According to EN ISO 4892-3, UV aging of bone shaped samples was performed in a UV chamber fitted with UVA-351 style fluorescent lamps. In order to evaluate the change in mechanical properties caused by UV radiations, both pure polymer and composite samples were put in a UV chamber for 2000 hours. After that, UV-aged samples were used to conduct mechanical examination.

## **4. RESULTS AND DISCUSSIONS**

### **4.1 Flexural properties of composites**

#### **4.1.1 Effect of fibre type and content**

To determine the mechanical properties of polymer fibre reinforced composite, bending tests were conducted. The bending behaviour of produced composites was compared with the bending properties of virgin polymer samples. All samples presented in Table 1 have been tested. The values gained from bending test show a substantial difference in bending properties and vary as a function of the fiber content.

Figures #10a and 10b demonstrate the results of flexural strength and flexural modulus, respectively, for fiber reinforced PE composites. As can be seen from the figure 10a and 10b, a significant improvement in the flexural strength and flexural modulus for the fiber-reinforced PE composites, compared with virgin PE, is noticed. As example, the flexural strength of the PE/PETf composites increased by 15%, 53%, 61%, and 66%, respectively, for 10%, 30%, 40% and 50% fiber content. Similarly, the flexural modulus, which is the measure of material bending rigidity, increases by 16%, 42%, 52%, and 62% for 10%, 30%, 40% and 50% PETf-reinforced PE composites, respectively. Polymer matrices generally are relatively weak, low-stiffness, viscoelastic materials. The strength and stiffness of composites come primarily from the reinforcing fibers. The stronger reinforcement effect is observed for composites with cotton fibers. As can be seen from figures 10a and 10b, with addition of CF to PETf (in ratio 50/50) flexural strength and modulus of such PE/(CF+PETf) composites increased in 1.2-1.6 times (the higher the fiber content in composites the higher is the difference in strength and modulus values) compared to PE/PETf composites. The difference in flexural strength and modulus between PE/PETf and PE/CF are even higher, in 1.6-1.8 times. It can be explained by the fact that strength and rigidity of composites is mainly determined by the properties of reinforcement. It is well known that CFs have higher values of flexural and tensile modulus than PETf [55]. CF tensile strength is approximately twice higher than that of PETf. Therefore CF-filled composites exhibit higher values of strength and rigidity than PETf-filled materials. Moreover, the flexural strength and flexural modulus of PE/CF-50, as example, is higher by approximately 200% and 600%, respectively, than those of virgin PE.



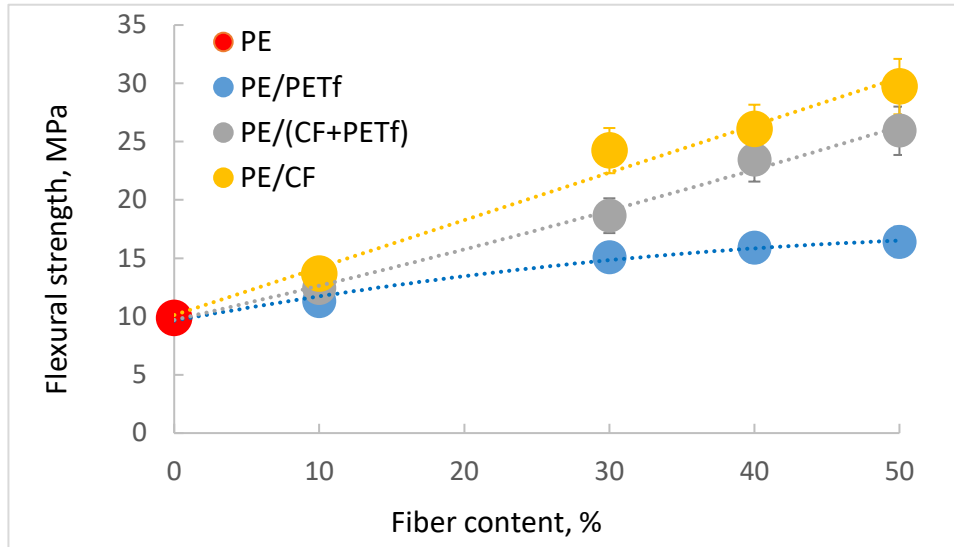

**Figure 10a.** Dependence of flexural strength of PE-based composites on fiber loading.

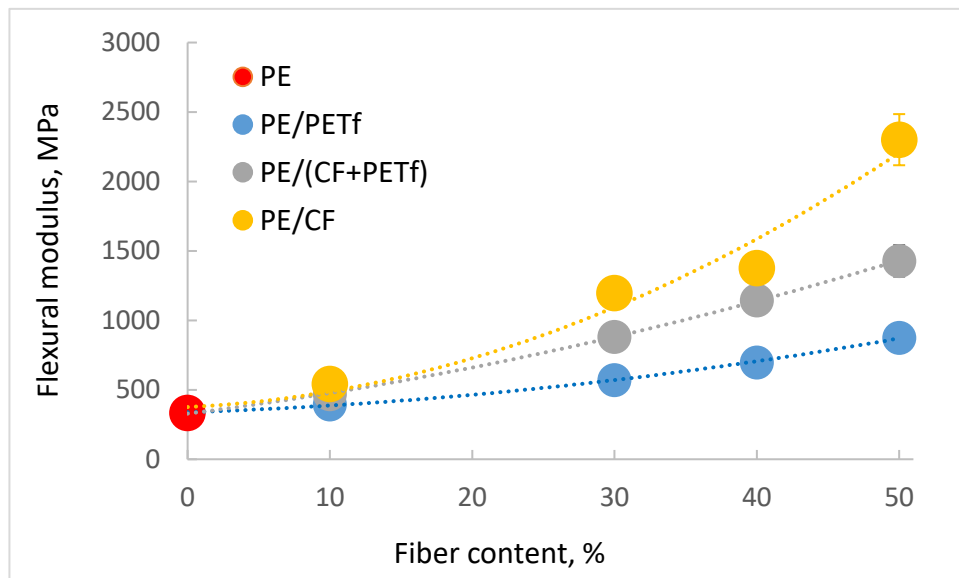

**Figure 10b.** Dependence of flexural modulus of PE-based composites on fiber loading.

The similar trend is observed for fiber reinforced composites based on recycled PE. As can be seen from Figures 11a and 11b, the flexural strength and flexural modulus of the Re-PE based composites increases with increasing fiber content.

Generally, the flexural properties of PE and Re-PE based composites are improved in the following order by fiber type: PETf < CF+PETf < CF. Similarly, the higher the fiber content, the higher is the flexural strength and rigidity of composites.

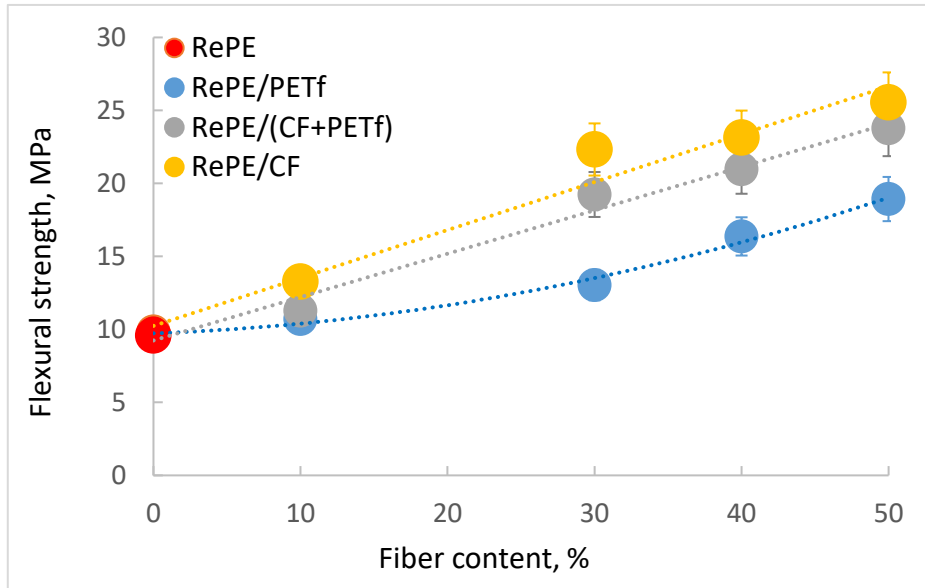

**Figure 11a.** Dependence of flexural strength of Re-PE-based composites on fiber loading

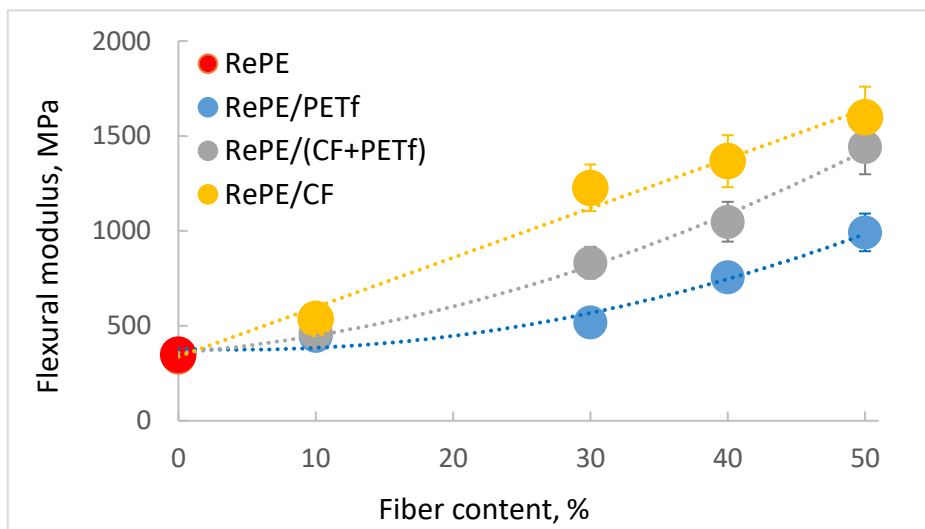

**Figure 11b.** Dependence of flexural modulus of Re-PE-based composites on fiber loading.

This can be explained as the fiber reinforcement restricts the bending movement of the PE and Re-PE matrix, so that the flexural strength and modulus increases with an increase in the fiber loading.

Another behaviour is observed for PP-based composites. Figure 12a and 12b shows the results of flexural strength (12a) and flexural modulus (12b) of fiber-reinforced PP composites.

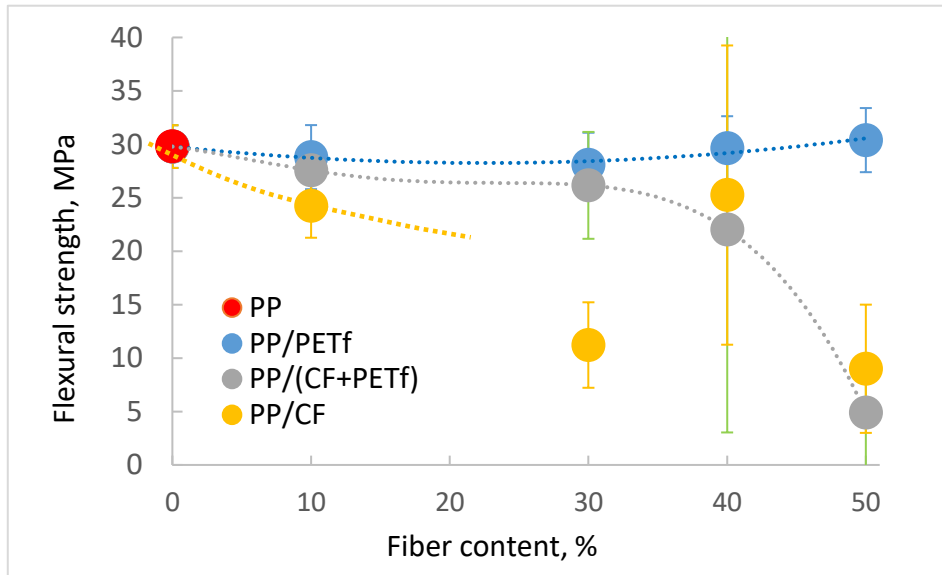

**Figure 12a.** Dependence of flexural strength of PP-based composites on fiber loading.

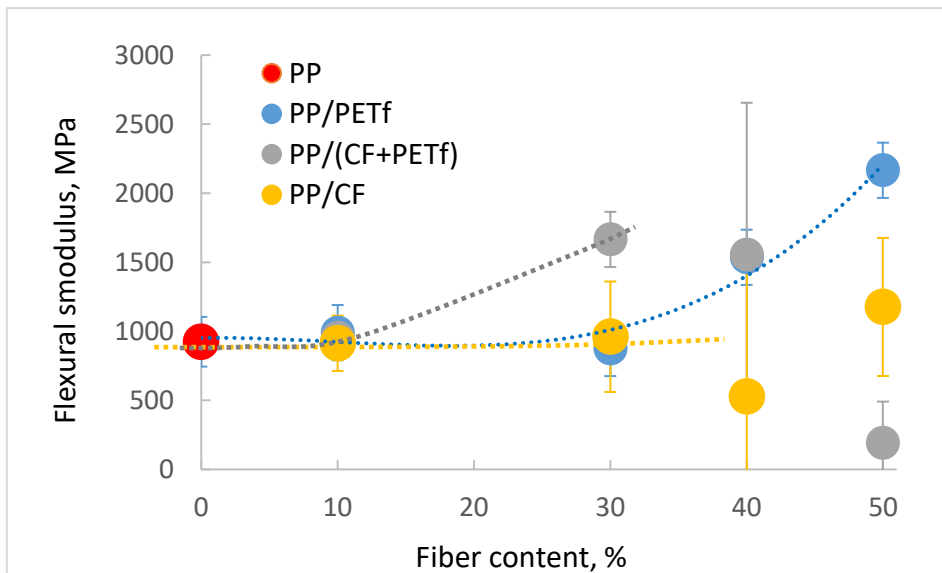
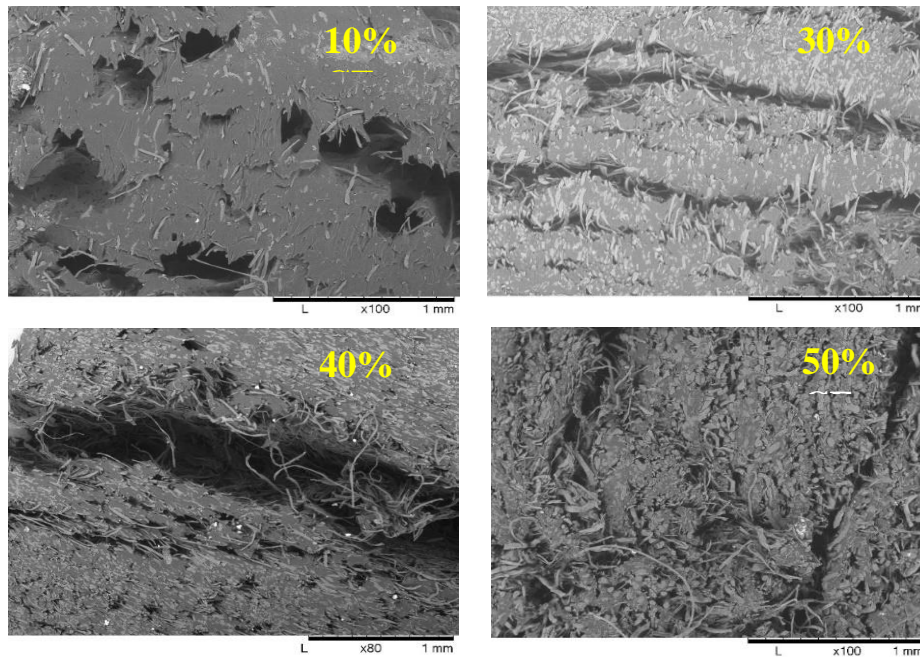

**Figure 12b.** Dependence of flexural modulus of PP-based composites on fiber loading

For PP/PETf composites there were no considerable changes in flexural strength when compared with 100% PP. Bending rigidity of material (flexural modulus) is also not affected by fiber content up to 30% loading. However, at 40% and 50% fiber content the bending rigidity of PP/PETf is increased by 66% and 134%, respectively compared to PP.

For PP/(CF+PETf) and PP/CF composites the preparation of good quality samples with 30%-50% fiber content turned out to be a challenging task. Regardless of several profits, natural fibre reinforced composites have some downsides, which is their less interface compatibility with polymer matrix, dipping effective matrix to fibres stress

transfer, which eventually reduces their mechanical properties. As can be seen from SEM images presented in Figure 13, increasing the CF content in PP material cause an increase in the number and size of voids.



**Figure 13.** SEM images of PP/CF composites with different CF content.

Similar morphology is detected for PP/(CF+PETf) composites as it is obvious from Figure 14 where selective images of PP-based samples filled with different fiber type is presented.

The morphology of PP/PETf composites is rather homogeneous, without enormous cavities, voids and cracks. With addition of CF fibers to PP matrix, general morphology of composites deteriorates significantly. Such effect is detected only for PP-based composites.

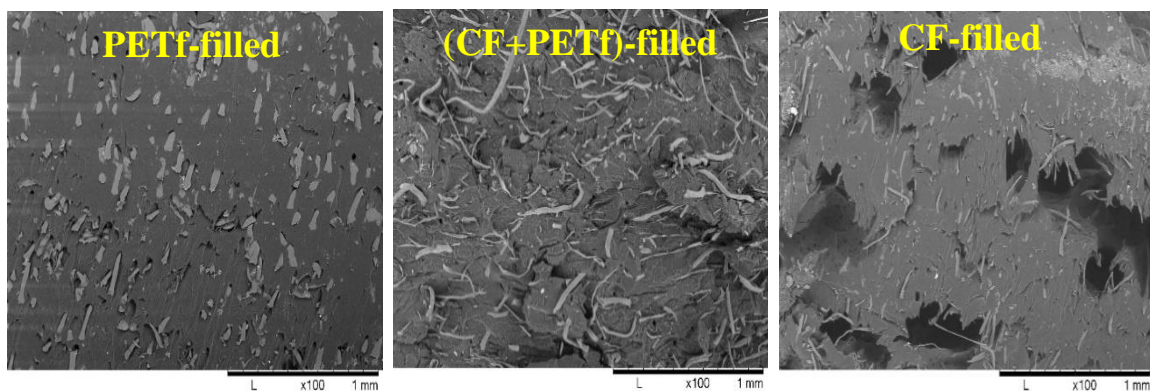

**Figure 14.** SEM images of PP based composites filled with PETf, (CF+PETf), and CF. Fiber content is 10%.

The preparation of PP/CF samples was repeated twice at elevated temperature and at higher compressive load, however no high-quality specimens were produced. As a result, the obtained data contain enormous experimental errors (20-50%) as can be seen from figure 12a and 12b and therefore will be skipped from further consideration.

It can only be concluded that PP/(CF+PETf) and PP/CF composites with fiber content higher 30% have poor flexural strength and stiffness due to low-quality of samples. PP/CF and PP/(CF+PETf) with 10% and 30% fiber loading demonstrates lower values of flexural strength than PP and PP/PETf, while flexural modulus either does not change (see PP/CF-10, PP/CF-30, PP/(CF+PETf)-10) or slightly improved (for PP/(CF+PETf)-30).

#### 4.1.2 Effect of polymer type used as matrix

The effect of polymer type on the flexural behavior of studied composites is presented in Figure 16 (a-f). As can be seen from the figure, there are no considerable difference in flexural properties between PE and Re-PE based composites – the values differs within experimental errors. Exception is only for PE/CF which shows values higher than for Re-PE/CF.

Among all polymer matrixes used PP demonstrates almost twice higher flexural strength and rigidity, especially for PETf filled composites. However, with addition of natural fibers flexural properties of PP-based composites deteriorates sufficiently and at high fiber loading ( $\geq 30\%$ ) no reliable results can be obtained. Figure 15 shows SEM images of (CF+PETf)-filled composites based on PP and PE for comparison. The fiber content in these samples is the same, 40%. Noted, that similar behavior is observed for samples with 10, 30 and 50% fiber content. As can be seen, PE creates homogenous phase with CF and PETf fibers, while PP contains a lots of micro and macro voids between polymer matrix and fibres, cracks which are actually delamination formed between PP and fibres layers. It turn disturbs final mechanical performance of PP-based samples.

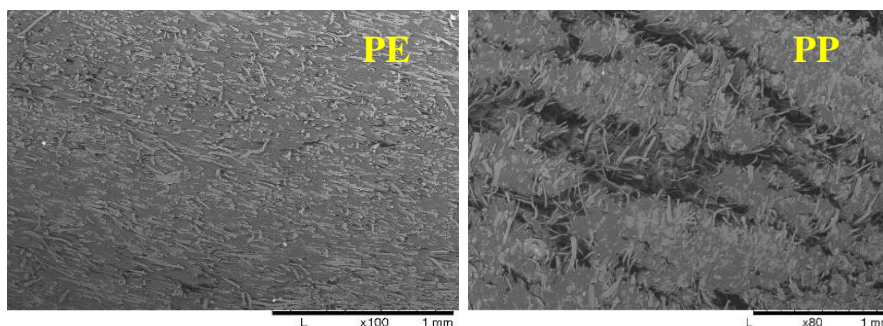

**Figure 15.** SEM images of (CF+PETf)-filled composites based on PE and PP. Fiber content is 40%.

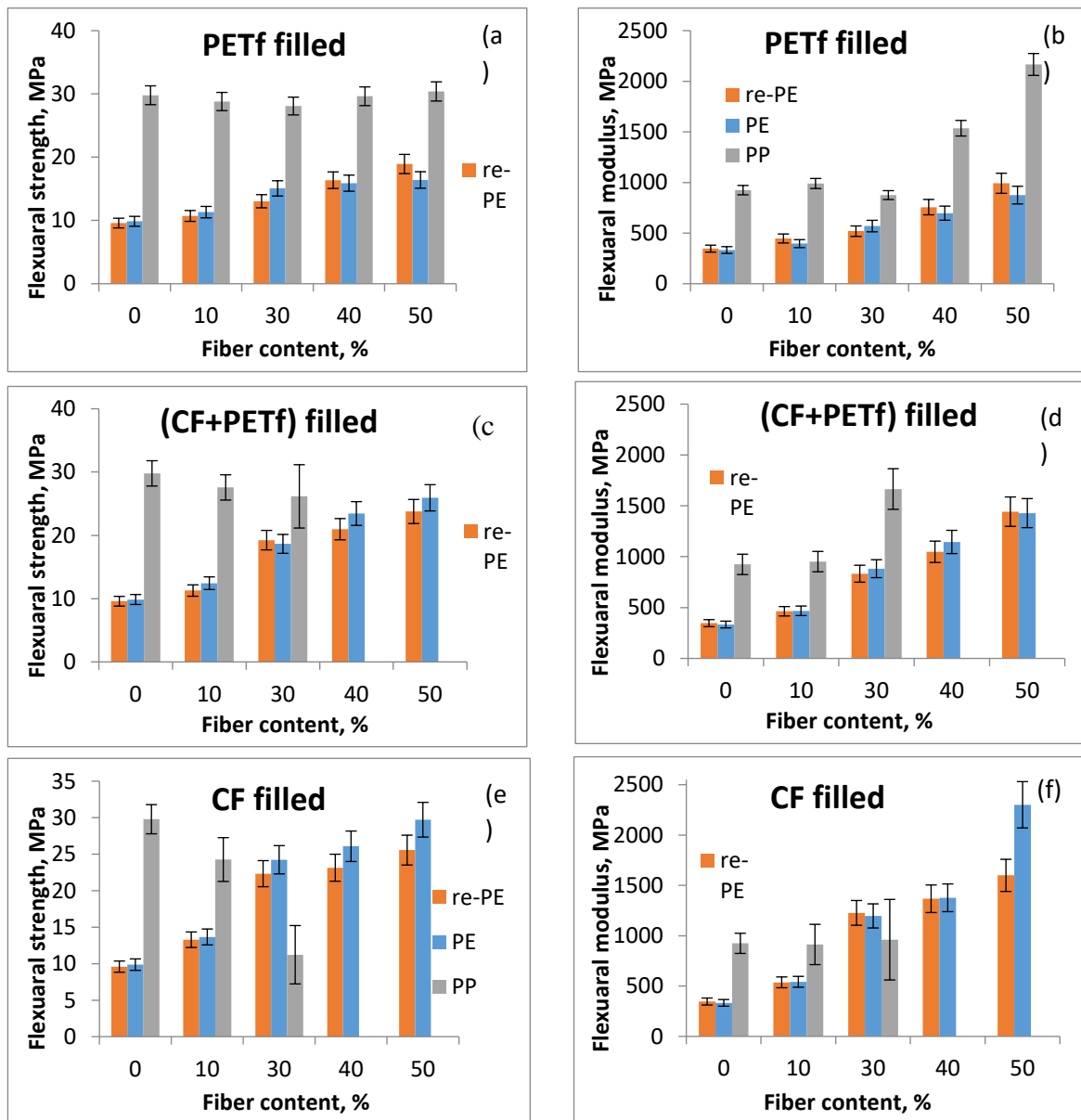

**Figure 16.** Effect of matrix polymer type (PE, Re-PE and PP) on flexural properties of studied composites.

## 4.2 Tensile properties of composites

Tensile tests were performed to determine the mechanical properties of the polymer fibre reinforced composite. To better understand the difference in behaviour of materials with their tensile testing capacities, the tensile behaviour of manufactured composites is compared to the tensile properties of pure polymer samples. The outcomes of the tensile test highlight the difference in tensile properties, which varies depending on the amount and type of fiber used, as well as on polymer type used as matrix.

### 4.2.1 Effect of fibre type and content

Figures 17-19 shows the effect of fiber content and type on tensile properties of studied composites. As can be seen from the figures 17 and 19, fibre reinforced polymer composites have considerably lower tensile strength than pure matrix polymers.

For all studied composites it is observed that with increasing fiber content in composites tensile strength of materials is sufficiently decreasing irrespective on fiber type. As can be seen from figure 6, CF and PETf, and their mixture, affect tensile strength values of composites in a similar manner. No fiber type effect on tensile strength can be detected.

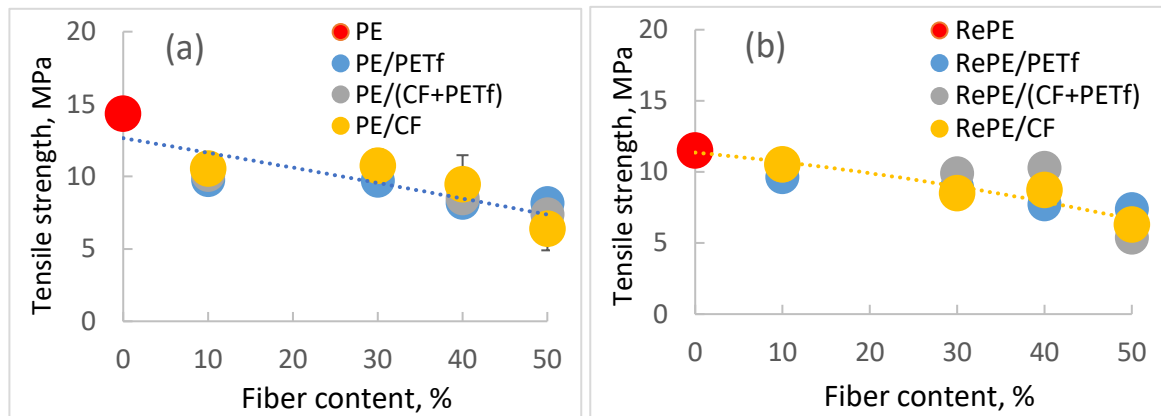

**Figure 17.** Dependence of tensile strength of PE-based (a) and Re-PE-based (b) composites on fiber loading.

The decrease in ultimate tensile strength with an increase in fiber content can be explained by an increase in number and sizes of voids present in the material due to poor interface bonding. This statement is confirmed by morphology observation, selected SEM images are presented in Figure 18. The similar trend in morphology is detected for all studied samples.

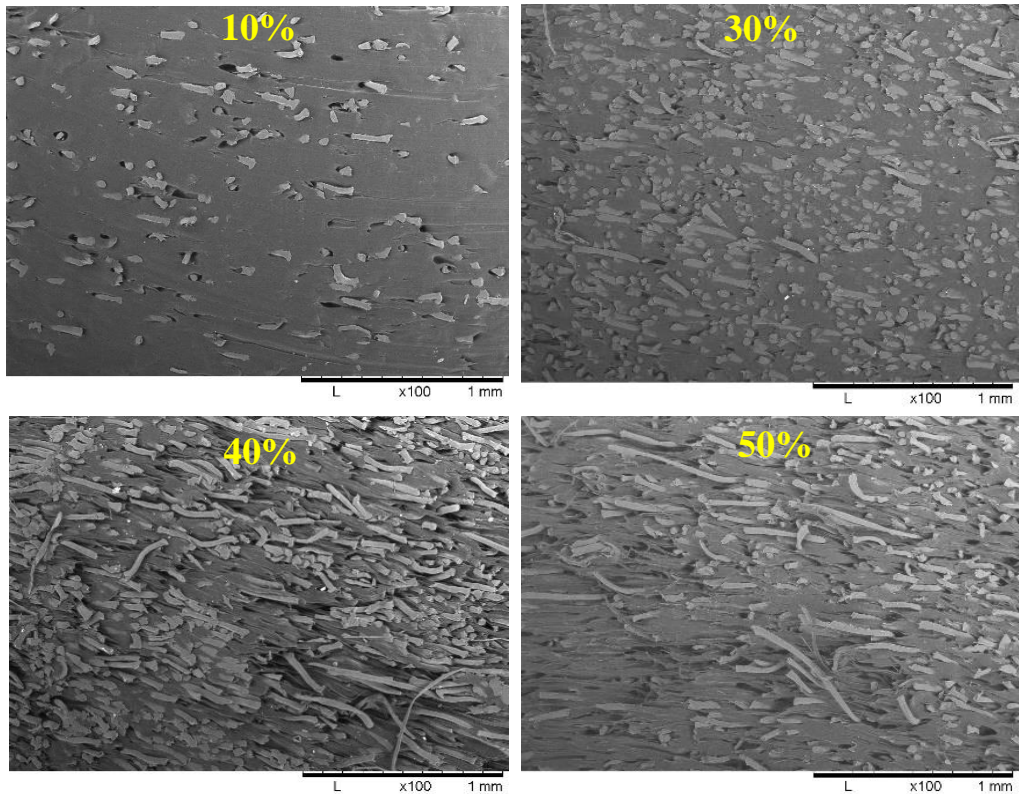

**Figure 18.** SEM images of PE/PETf composites with different fiber loading (10-50%).

Tensile strain at break, which is along with tensile strength provides information about material toughness, decreases with increasing fiber content, as can be seen in Figure 19. Both for PE and RePE based composites tensile strain decreases from 550% (in average) to 1% with increasing fiber loading.

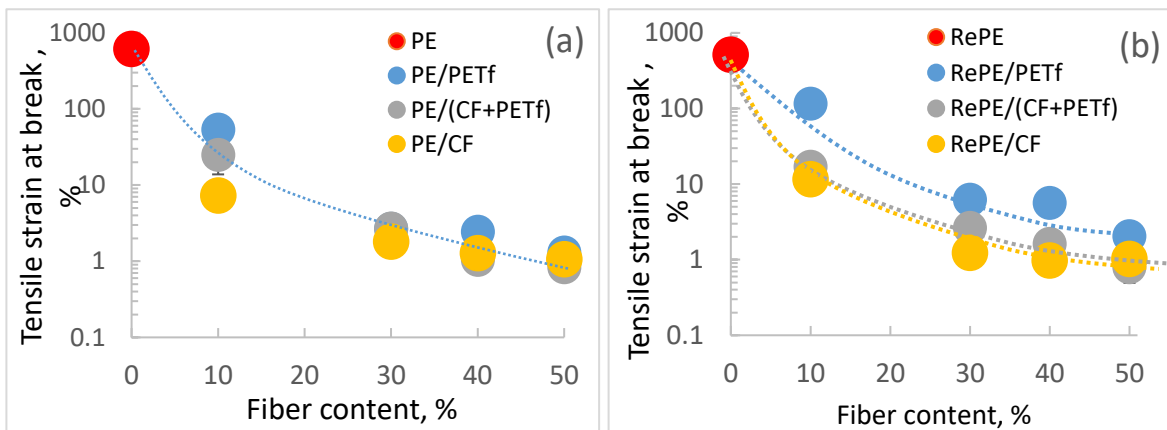
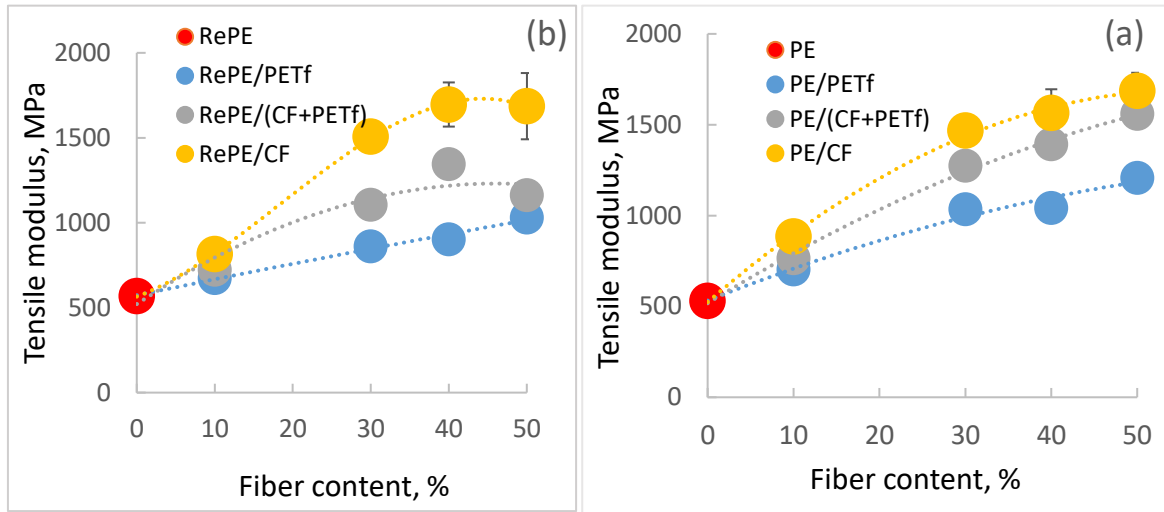

**Figure 19.** Effect of fiber content and type on tensile strain at break (presented in logarithmic scale) of PE-based (a) and RePE-based (b) composites.

PETf gives composites with slightly better elongation properties (higher tensile strain at break values) than CF or CF+PETf. Decrease in tensile strain with fiber loading is



accompanied by huge increase in tensile stiffness of samples, as it is obvious from figure 20.



**Figure 20.** Effect of fiber content and type on tensile modulus of PE-based (a) and RePE-based (b) composites.

Fiber type strongly affect the tensile modulus values: maximum twice increase of modulus is observed for PETf-filled samples compared to matrix polymer, whereas for CF-filled samples thrice increase in modulus is detected. Mixture of (CF+PETf) gives tensile modulus somewhat in between those for CF- and PETf -filled composites. The observed trend is in accordance with flexural properties. Taken into account similar morphology of composites, prepared with different fiber type (see Figure 21), it can be concluded that fiber type and its properties affect the strength and rigidity of fiber-filled composites: the stiffer the fibers the stiffer is the composites.

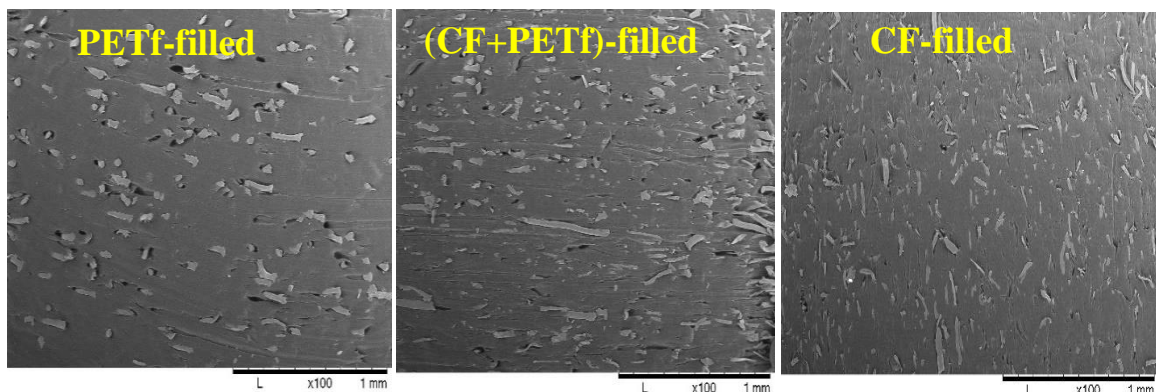

**Figure 21.** SEM images of PE based composites filled with PETf, (CF+PETf), and CF. Fiber content is 10%.

The higher the stiffness of composites the lower is the values of tensile strength and elongation at break. It means that with increasing fiber loading materials become less tough and more fragile. Presence of fiber pull-outs, voids and fiber dislocation identified from Fig. 15, 18, 21 are due to improper bonding between fiber and matrix, leading to less tough composites.

Results of differential scanning calorimetry can serve as an additional confirmation of improper interface bonding. Figure 22 shows thermograms of PE/PETf composite and its pure components, namely pure PE and pure PETf.

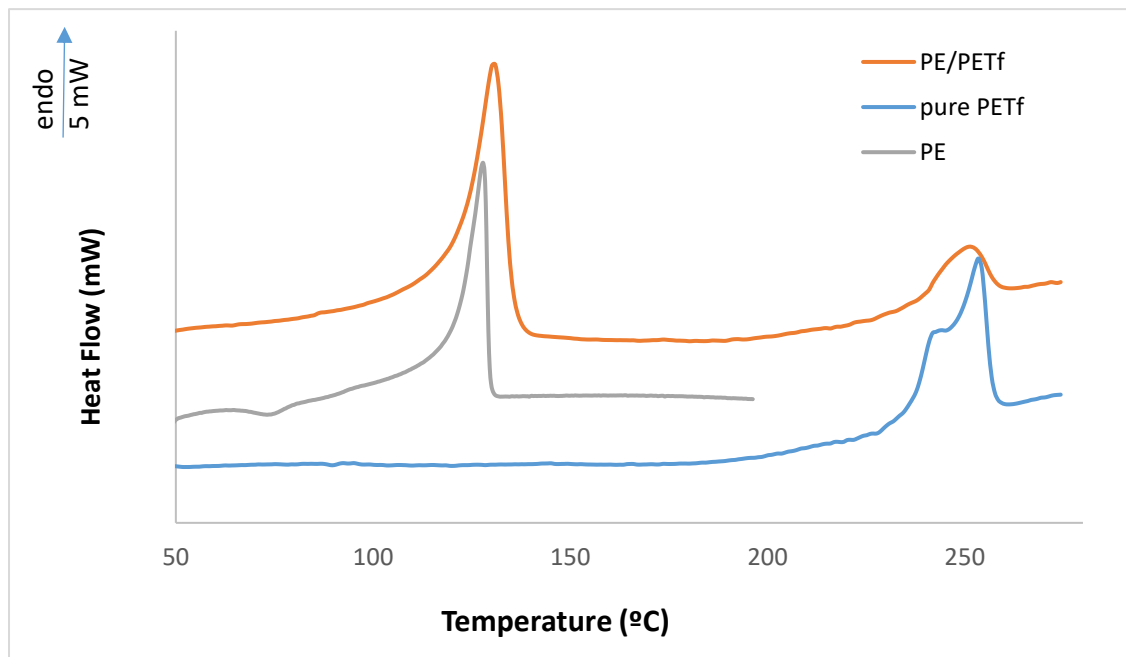

**Figure 22.** DSC melting (right) traces of the PE/PETf-30 composite and its components, PE and PETf. Heating rate is 20 °C/min.

Pure PE component has mainly one melting peak at 128°C. The same is found for pure PETf, which has melting point at 251°C. However, two peaks can be indicated for PE/PETf composite. To find out whether the observed melting peaks corresponds to completely separated crystallites, formed independently, the enthalpy of fusion of low (PE) and high (PETf) temperature peak was compared with the expected value in the blend (70/30 PE/PETf) if both components had crystallized independently. Table 2 shows that the measured enthalpy of the low-temperature peak related to PE, as well as of high temperature PETf peak, is similar to that calculated assuming independent crystallites.

**Table 2.** Enthalpy of fusion for 70/30 PE/PETf composite obtained from melting thermograms.

	pure PE	pure PETf	PE/PETf-30 composite		
	measured, J/g	measured, J/g	calculated, J/g		measured, J/g
$\Delta H_{PE \text{ peak}}$	140.4	-	$0.7 \cdot \Delta H_{PE \text{ peak}}$	98.3	97.8
$\Delta H_{PETf \text{ peak}}$	-	45.5	$0.3 \cdot \Delta H_{PETf \text{ peak}}$	13.6	13.5
$\Delta H_{\text{overall}}$	140.4	45.5	$\Delta H_{\text{overall}} =$ $0.7 \cdot \Delta H_{PE \text{ peak}}$ $+ 0.3 \cdot \Delta H_{PETf \text{ peak}}$	111.9	111.3

Overall enthalpy of fusion of both peaks is also identical to that calculated by mentioned above method. Similar behaviour was observed for PE/CF composites. No changes in the blends compared to the pure blend components is an argument in favour of absence any co-crystallization in observed composites meaning that two phases exist independently in composites leading to poor toughness properties.

It is especially revealed for PP-based composites. As can be seen from Figures 23 and 24, with increasing fiber content tensile strength as well as tensile modulus and strain at break decrease drastically.

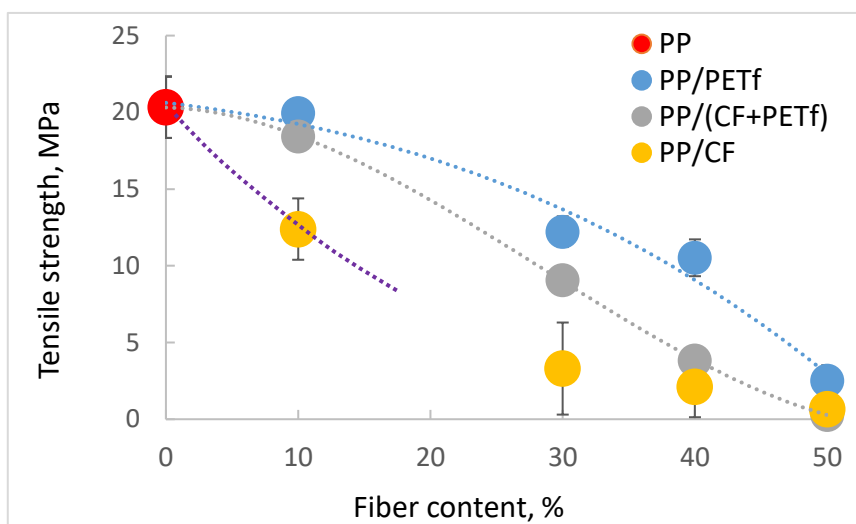

**Figure 23.** Dependence of tensile strength of PP-based composites on fiber loading.

As it was mentioned before, PP/CF and PP/(CF+PETf) have poor material quality and as a result, high standard deviation of obtained values at fiber content  $\geq 30\%$  (indicated in figures 22 and 24).

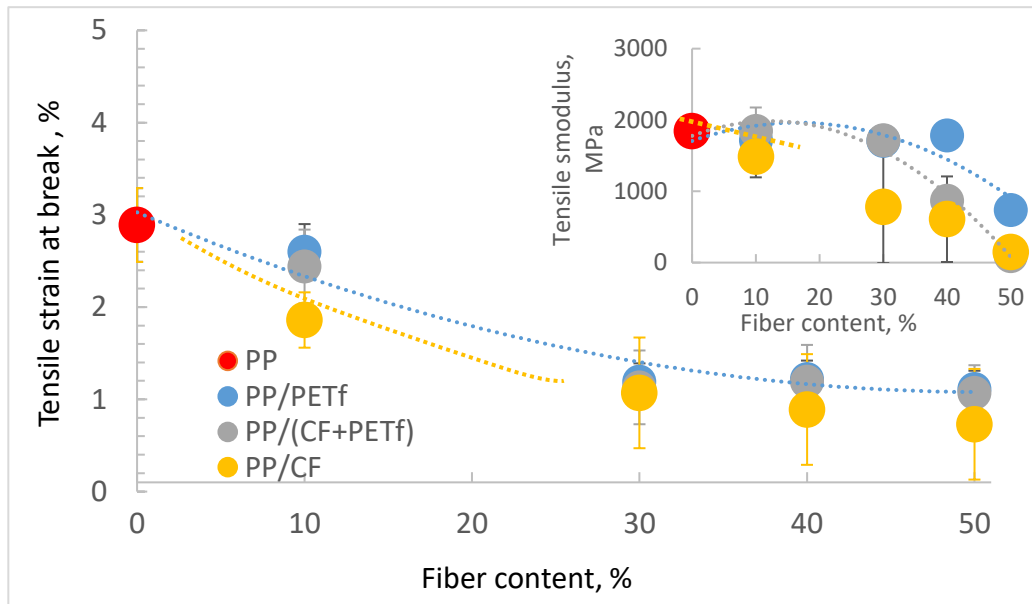

**Figure 24.** Dependence of tensile strain at break of PP-based composites on fiber loading. Inset demonstrates the effect of fiber content on tensile modulus.

#### 4.1.2 Effect of polymer type used as matrix bending test

The matrix, or binder, maintains the position and orientation of the reinforcement. Therefore, effect of matrix type on tensile properties have been evaluated and presented in Figure 25. As it is clear seen, no considerable difference is identified between PE- and Re-PE based composites, while pure PE demonstrates slightly higher tensile strength values compared to recycled one. PP/PETf composites exhibit higher values of tensile strength and modulus than PE and RePE based samples at fiber loading 10-40%, whereas PP/CF and PP/(CF+PETf) have highest tensile strength and modulus only at 10% fiber loading.

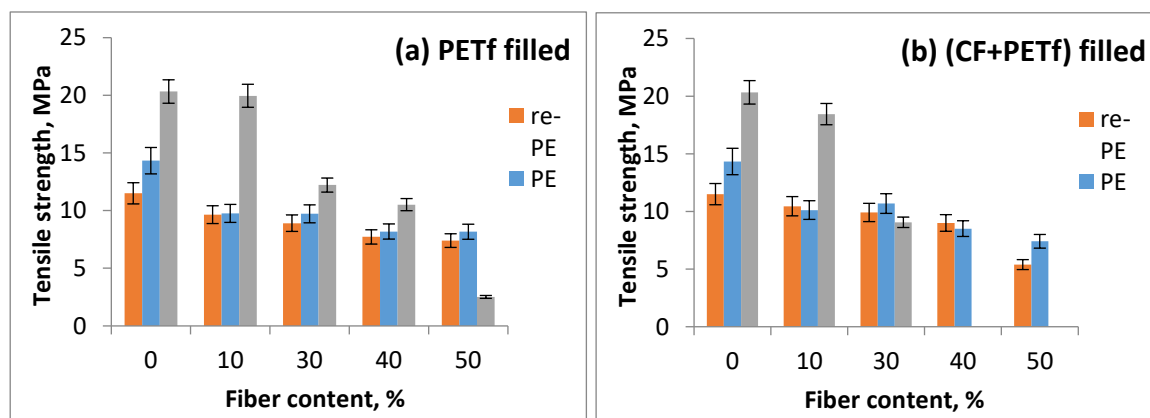

**Figure 25.** Effect of matrix polymer type (PE, Re-PE and PP) on tensile strength of studied composites. (a) Data are for PETf-filled composites; (b) Data are for (CF+PETf)-filled composites.

The same is true for tensile modulus and strain at break: values for PE- and RePE-based composites are identical within experimental error, as seen from Figure 26. PP-based samples have always lower values of tensile strain and higher values of tensile modulus than polyethylene-based composites.

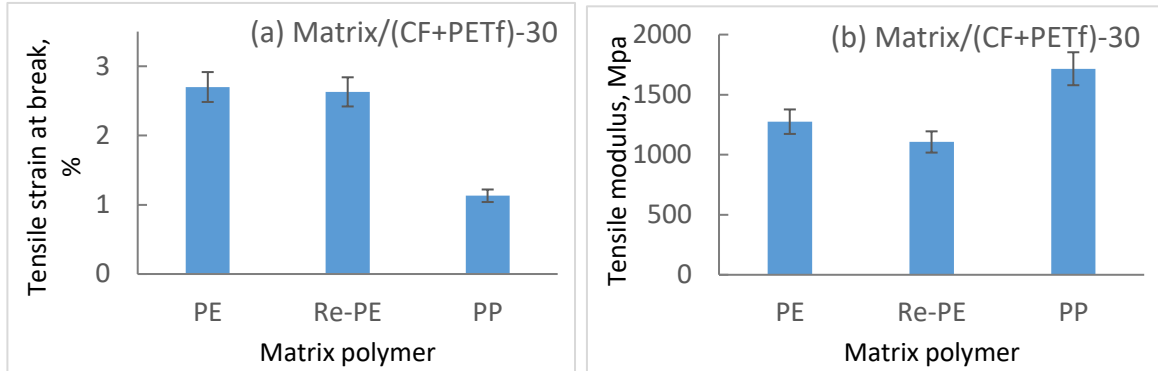

**Figure 26.** Effect of matrix polymer type (PE, Re-PE and PP) on tensile strain at break (a) and tensile modulus (b) for (CF+PETf)-filled composites. Fiber content is fixed at 30%.

Hence, no improvements of flexural and tensile properties of PP-based composites has been observed. Probably, the sample preparation process should be significantly changed and adapted to PP in order to prepare fiber-filled composites with proper mechanical performance.

### 4.3 Impact test

The impact strength of pure polymer samples and their composites using various fibers with varying ratios are summarized in figure 27. The impact strength of pure PE and pure RePE samples are higher than their composites but it is vice versa for PP composites. For example, the impact strength of 100% PE is 21.21 KJ/m<sup>2</sup>, while the addition of 10% CF into it, reduces its impact strength up to nearly 71%. Similarly, introducing 10% CF to RePE reduces its strength by half (as shown in figure 27). This shows that the presence of fibre in PE or RePE significantly decreases the strength of composite.

Although, the combination of RePE and CF gives lower damage resistance than pure RePE sample, a continuous improvement in strength can be seen by increasing the percentage of cotton fibres. In other words, the more cotton fibres we add, the higher the impact strength becomes. For instance, RePE with 10% cotton fibres has an impact strength of 6.35 KJ/m<sup>2</sup>, while RePE with 50% cotton fibres has 44 percent higher strength (i.e., 9.14 KJ/m<sup>2</sup>). In PP composites, a similar trend can be observed. It can

be noticed that, pure polypropylene has the lowest tendency against impact ( $1.85\text{KJ/m}^2$ ), but it increases gradually as the quantity of cotton fibres increases in it till 40% fibre ratio and it starts declining from 50% fibre ratio. No obvious influence on composites is noticed when PET fiber ratio varies. It can be concluded that impact strength in PP/Cf composites is directly proportional to cotton fiber ratio, same like in RePE/CF composites.

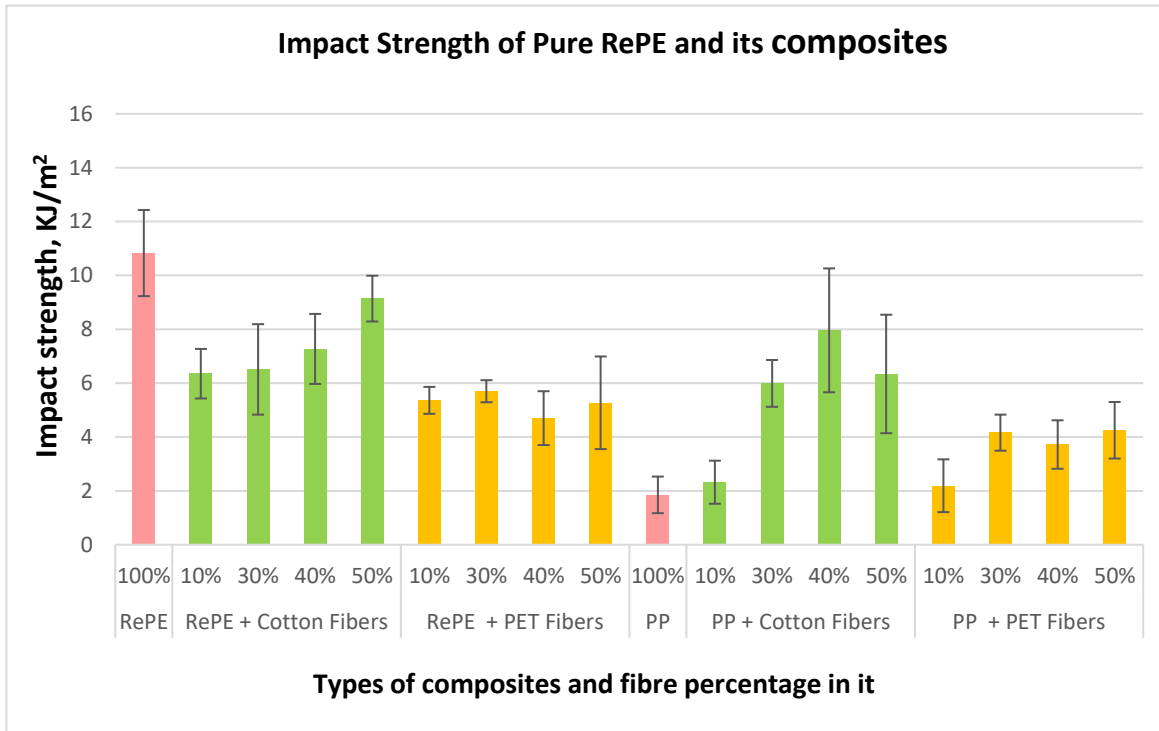
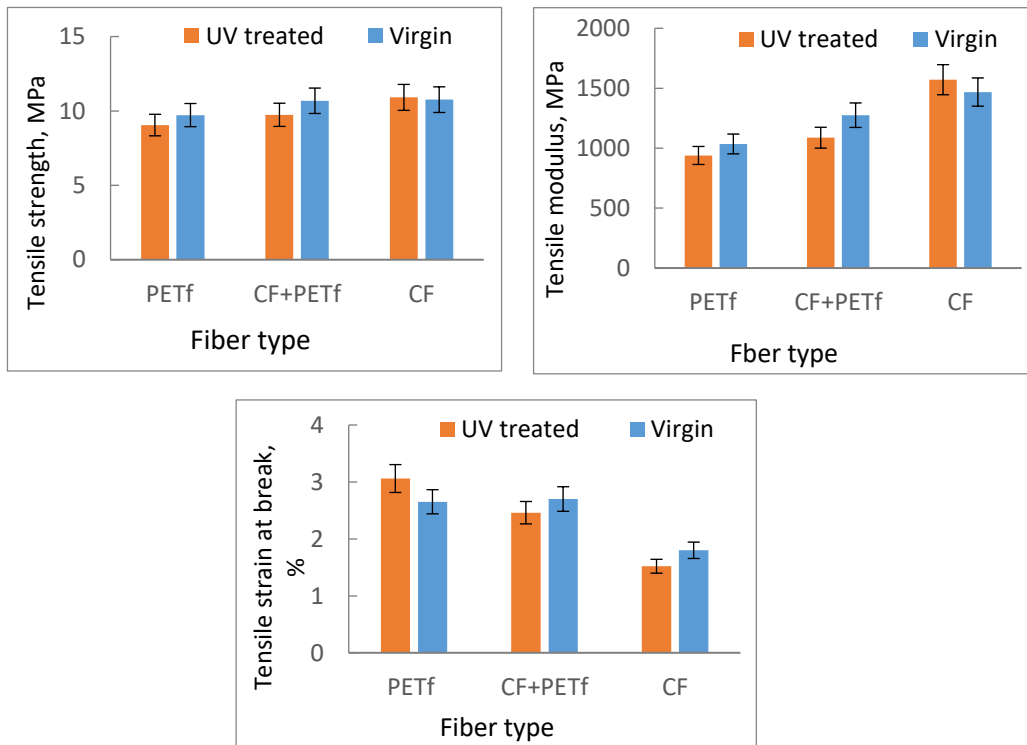

**Figure 27.** Comparison of impact strength of RePE and pure PP samples and their composite samples having different fibers and their ratios.

#### 4.4 Environmental impact on mechanical performance (tensile strength) of composite

The accelerated aging effect on the fiber reinforced PE and RePE based composites was examined using tensile tests to evaluate tensile properties of the material during the aging process. The fiber content was chosen to be 30% (intermediate between others). For this purpose, ultraviolet (UV) chamber was used as accelerated aging technique. Figure 28 represents the results of tensile strength, modulus and strain at break for PE-based composites, as example. Similar behaviour was detected for RePE-based samples. As can be seen from the figure, there is no considerable difference between virgin and UV treated samples. Therefore, it can be concluded that both PE and RePE based composite materials are resistant to the UV aging by demonstrating no

considerable change in tensile properties due to the accelerated aging process. PP based composites have not been tested due to improper sample quality.



**Figure 28.** Tensile properties of PE-based composites with different fibers before and after UV treatment. Fiber content is 30%.

## CONCLUSIONS

1. During the work cost-effective cotton and PET fiber filled thermoplastic composites was prepared by compression molding. It was possible to produce composites with 10-50% fiber loading.
2. PE and RePE composites show almost similar mechanical performance that strongly differs from PP.
3. The higher the fiber loading, the higher the flexural strength (up to 600% improvement) and rigidity (flexural and tensile) of both PE and RePE-based composites. The mechanical performance of such composites are improved in the following order by fiber type: PETf < CF+PETf < CF.
4. Tensile and impact strength as well as toughness of PE and Re-PE based composites decreases, probably due to insufficient interface bonding.
5. Studied PE-based composites demonstrated good resistance to the UV aging.
6. Incorporation of fibres in PP matrix deteriorates flexural and tensile strength of composites whereas the impact strength is improved. Addition of cotton fibers results in poor composite quality and consequently in poor mechanical performance of PP based composites.
7. Compression molding is suitable technique to produce organo-fibre filled composites based on PE or RePE but not on PP matrix, especially with cotton fibres.



## SUMMARY

Compounding and compression molding of PE, RePE, with polyester, cotton and a blend of cotton and polyester fibers up to 50% by weight is conceivable. However, the processing of PP with organofibers are possible up to 10% fibre ratio only. The characteristics of all produced composites are closely linked to the qualities of their constituents such as fibre type and polymer matrix.

The flexural strength of composite materials composed of PE and RePE filled with organofibres increases as the fibre content increases. Among all categories of fibre reinforced composites that were produced, PE with cotton fibre showed the highest flexural strength, even higher than strength of virgin PE. Introduction of 50% cotton fibres in to PE increased bending strength up to 200%. Similarly, with an increased content of fibre ratio, the modulus of elasticity improved, resulting in an extra rigidity of the material. In case of polypropylene, only PET fibres showed compatibility to be reinforced with PP matrix, whereas due to worst quality of composites produced by PP with above 10% cotton fibres, results were not achieved for flexural and tensile properties.

In terms of the structure of the composites containing organo fibres, the influence of fillers and matrix on different mechanical properties varies depending on the type and fraction of filler and matrix employed. SEM analysis shows that fillers were dispersed well in the PE/organofibres and RePE/organofibres composites and have a fairly homogenous morphology, with no voids, holes, or cracks. Whereas the general morphology of composites degrades dramatically when CF fibers are added to the PP matrix. As the fiber content in all types of composites increased, regardless of fiber type, the stiffness of the composites also increased. Consequently, tensile strength of composites decreases substantially. Also, composites become brittle and less durable. It is worth noting that, when compared to all pure matrices and generated composites, the impact strength of polypropylene fibre reinforced composites increased dramatically with the addition of cotton fibers. Furthermore, both PE and RePE-based composite materials are shown to be UV-resistant, with no significant changes in tensile properties as a result of the accelerated aging process.

The findings of the study revealed that waste textile fibers can be utilize as fillers or reinforcement material with polymer matrix such as PE, RePE and PP to make composites by compression molding method. However, the fibre ratio of cotton fibres in polypropylene is restricted to just 10% only. In addition, it is revealed that, the use of these organofillers with neat poymer matrix as well as recycled polymers could be a

cost-effective way to produce composites. Furthermore, these can be manufactured by one of the most economical technique of compression molding. These findings demonstrate that it is possible to prepare high-performance composite materials from waste without using coupling agent.

## KOKKUVÕTE

Uuriti polüetüleen (PE), ringluse võetud polüetüleen (RePE), puuvilla (CF), polüestri (PETf) ja nende kiudude segust (CF+PETf) komposiitide valmistamise võimalust kuumpressimismeetodil. Leiti, et PE ja RePE ning kiudude segust õnnestub komposiiti valmistada kuni 50 massiprotsendilise kiudude sisalduse korral. Polüpropüleen (PP) segamine orgaaniliste kiududega on siiski võimalik ainult kuni 10% kiudainesisaldusega.

PE ja RePE täidisega komposiidi paindetugevus suureneb koos kiudude osakaalu suurenemisega. Samamoodi paraneb komposiitide tõmbetugevus ja paindejäikus. Kiu tüüpi arvestades parandatakse komposiitide mehaanilisi omadusi järgmises järjekorras: PETf < CF+PETf < CF. Puuvillakiududega PE näitas paindetugevuse paranemist kuni 600% võrreldes puhta PE-ga. Morfoloogiline uuring näitas, et täiteained olid orgaaniliste kiudude ja polüetüleeni komposiitides hästi hajutatud ning neil on üsna homogeenne morfoloogia, väheste tühimike või pragudega. Komposiitide tõmbetugevus ja sitkus langevad aga kiu sisalduse suurenemise korral drastiliselt. Selle tulemusena on komposiitide löögitugevus puhtast polümeermaatriksist oluliselt madalam. Samas on uuring näidanud, et nii PE- kui ka RePE-põhised.

PP maatriksit tugevdasid teataval määral ainult PETf kiud. Puuvillakiudude lisamine halvendas üldist morfoloogiat, mis väljendub materjalis esinevate tühimikena. PP-põhiste komposiitide painde- ja tõmbetugevus ning jäikus vähenevad kiudude kontsentratsiooni suurenemisel. Üllataval kombel suureneb puhta PP-ga võrreldes puuvillakiudude lisamisega polüpropüleenil põhinevate komposiitide löögitugevus.

Uuringu tulemused näitasid, et enamlevinud tekstiilkiude saab ringluse võtta polümeermaatriksi, näiteks PE, RePE ja PP täiteainetena, et valmistada kuumpressimismeetodil jäätmetest jätkusuutlikke ja tasuvaid komposiite.

## REFERENCES

- [1] R. Potluri, K. James Paul, S. Abdul Kalam, and P. Prasanthi, “Mechanical Properties Characterization of Okra Fiber Based Green Composites & Hybrid Laminates,” *Mater. Today Proc.*, vol. 4, no. 2, pp. 2893–2902, 2017, doi: 10.1016/j.matpr.2017.02.170.
- [2] M. P. Todor, C. Bulei, T. Heput, and I. Kiss, “Researches on the development of new composite materials complete / partially biodegradable using natural textile fibers of new vegetable origin and those recovered from textile waste,” *IOP Conf. Ser. Mater. Sci. Eng.*, vol. 294, no. 1, 2018, doi: 10.1088/1757-899X/294/1/012021.
- [3] European Environmental Agency, “Textiles in Europe ’ s circular economy Key messages,” pp. 1–17, 2020, [Online]. Available: <https://www.eea.europa.eu/themes/waste/resource-efficiency/textiles-in-europe-s-circular-economy>.
- [4] S. et. al. Manshoven, “Plastic in textiles : potentials for circularity and reduced environmental and climate impacts,” *Eur. Top. Cent. Waste Mater. a Green Econ.*, p. 53, 2021.
- [5] G. Sandin and G. M. Peters, “Environmental impact of textile reuse and recycling – A review,” *J. Clean. Prod.*, vol. 184, pp. 353–365, 2018, doi: 10.1016/j.jclepro.2018.02.266.
- [6] “Textile Market Size | Industry Analysis Report, 2021-2028.” <https://www.grandviewresearch.com/industry-analysis/textile-market> (accessed Apr. 20, 2021).
- [7] C. Stone, F. M. Windsor, M. Munday, and I. Durance, “Natural or synthetic – how global trends in textile usage threaten freshwater environments,” *Sci. Total Environ.*, vol. 718, p. 134689, 2020, doi: 10.1016/j.scitotenv.2019.134689.
- [8] G. & F. N. B. Coskun, “Post-Consumer Textile Waste Minimization : A Review Journal of Strategic Research in Social Science ( JoSReSS ),” *J. Strateg. Res. Soc. Sci.*, no. 5(1), pp. 1–18, 2019, doi: 10.26579/josress-5.1.1.
- [9] “Global plastics industry - Statistics & Facts | Statista.” <https://www.statista.com/topics/5266/plastics-industry/> (accessed Apr. 20, 2021).
- [10] M. Seghiri, D. Boutoutaou, A. Kriker, and M. I. Hachani, “The Possibility of Making a Composite Material from Waste Plastic,” *Energy Procedia*, vol. 119, pp. 163–169, 2017, doi: 10.1016/j.egypro.2017.07.065.

- [11] “• Manufacture of plastic products: turnover 2008-2018 | Statista.”  
<https://www.statista.com/statistics/1045614/turnover-of-the-manufacture-of-rubber-and-plastic-products-in-estonia/> (accessed Apr. 20, 2021).
- [12] D. K. Rajak, D. D. Pagar, P. L. Menezes, and E. Linul, “Fiber-reinforced polymer composites: Manufacturing, properties, and applications,” *Polymers (Basel)*, vol. 11, no. 10, 2019, doi: 10.3390/polym11101667.
- [13] G. Sandin and G. M. Peters, “Environmental impact of textile reuse and recycling – A review,” *J. Clean. Prod.*, vol. 184, no. February, pp. 353–365, 2018, doi: 10.1016/j.jclepro.2018.02.266.
- [14] M. H. M. Hashim, A. R. M. Sam, and M. W. Hussin, “The future of external application of fibre reinforced polymer in civil infrastructure for tropical climates region,” *Int. J. Mech. Mater. Eng.*, vol. 6, no. 2, pp. 147–159, 2011.
- [15] M. Alberto, “Introduction of Fibre-Reinforced Polymers – Polymers and Composites: Concepts, Properties and Processes,” *Fiber Reinf. Polym. - Technol. Appl. Concr. Repair*, no. February, 2013, doi: 10.5772/54629.
- [16] E. C. Claunch, “Forecasting on composites – markets, products, and demands,” *J. Text. Apparel, Technol. Manag.*, vol. 9, no. 2, pp. 1–6, 2015.
- [17] M. Patel, B. Pardhi, S. Chopara, and M. Pal, “Lightweight Composite Materials for Automotive - A Review,” *Concepts J. Appl. Res.*, vol. 3, no. 7, pp. 1–9, 2018.
- [18] D. K. Rajak, D. D. Pagar, R. Kumar, and C. I. Pruncu, “Recent progress of reinforcement materials: A comprehensive overview of composite materials,” *J. Mater. Res. Technol.*, vol. 8, no. 6, pp. 6354–6374, 2019, doi: 10.1016/j.jmrt.2019.09.068.
- [19] I. D. Ibrahim, T. Jamiru, R. E. Sadiku, W. K. Kupolati, S. C. Agwuncha, and G. Ekundayo, “The use of polypropylene in bamboo fibre composites and their mechanical properties - A review,” *J. Reinf. Plast. Compos.*, vol. 34, no. 16, pp. 1347–1356, 2015, doi: 10.1177/0731684415591302.
- [20] T. G. Yashas Gowda, M. R. Sanjay, K. Subrahmanya Bhat, P. Madhu, P. Senthamaraikannan, and B. Yogesha, “Polymer matrix-natural fiber composites: An overview,” *Cogent Eng.*, vol. 5, no. 1, 2018, doi: 10.1080/23311916.2018.1446667.
- [21] K. L. Pickering, M. G. A. Efendy, and T. M. Le, “A review of recent developments in natural fibre composites and their mechanical performance,” *Compos. Part A Appl. Sci. Manuf.*, vol. 83, pp. 98–112, 2016, doi: 10.1016/j.compositesa.2015.08.038.

- [22] R. Hsissou, R. Seghiri, Z. Benzekri, M. Hilali, M. Rafik, and A. Elharfi, “Polymer composite materials: A comprehensive review,” *Compos. Struct.*, vol. 262, no. January, pp. 0–3, 2021, doi: 10.1016/j.compstruct.2021.113640.
- [23] A. Gholampour and T. Ozbakkaloglu, *A review of natural fiber composites: properties, modification and processing techniques, characterization, applications*, vol. 55, no. 3. Springer US, 2020.
- [24] Q. T. H. Shubhra, A. K. M. M. Alam, and M. A. Quaiyyum, “Mechanical properties of polypropylene composites: A review,” *J. Thermoplast. Compos. Mater.*, vol. 26, no. 3, pp. 362–391, 2013, doi: 10.1177/0892705711428659.
- [25] M. C. Fares, G. de Souza, and A. J. F. Carvalho, “Thermoformed Polypropylene Composite Reinforced with Cotton Fabric,” *Macromol. Symp.*, vol. 383, no. 1, pp. 1–6, 2019, doi: 10.1002/masy.201800068.
- [26] C. Elanchezhian, B. V. Ramnath, G. Ramakrishnan, M. Rajendrakumar, V. Naveenkumar, and M. K. Saravanakumar, “Review on mechanical properties of natural fiber composites,” *Mater. Today Proc.*, vol. 5, no. 1, pp. 1785–1790, 2018, doi: 10.1016/j.matpr.2017.11.276.
- [27] M. M. Kabir, H. Wang, K. T. Lau, and F. Cardona, “Chemical treatments on plant-based natural fibre reinforced polymer composites: An overview,” *Compos. Part B Eng.*, vol. 43, no. 7, pp. 2883–2892, 2012, doi: 10.1016/j.compositesb.2012.04.053.
- [28] I. G. Raftoyiannis, “Experimental Testing of Composite Panels Reinforced with Cotton Fibers,” *Open J. Compos. Mater.*, vol. 02, no. 02, pp. 31–39, 2012, doi: 10.4236/ojcm.2012.22005.
- [29] R. Gujjala, S. Ojha, S. K. Acharya, and S. K. Pal, “Mechanical properties of woven jute-glass hybrid-reinforced epoxy composite,” *J. Compos. Mater.*, vol. 48, no. 28, pp. 3445–3455, 2014, doi: 10.1177/0021998313501924.
- [30] G. L. Devnani and S. Sinha, “Effect of nanofillers on the properties of natural fiber reinforced polymer composites,” *Mater. Today Proc.*, vol. 18, pp. 647–654, 2019, doi: 10.1016/j.matpr.2019.06.460.
- [31] O. Faruk, A. K. Bledzki, H. P. Fink, and M. Sain, “Biocomposites reinforced with natural fibers: 2000-2010,” *Prog. Polym. Sci.*, vol. 37, no. 11, pp. 1552–1596, 2012, doi: 10.1016/j.progpolymsci.2012.04.003.
- [32] B. Ravi and B. S. Ramakrishna, “Plant Fiber Reinforced Polymer Matrix Composites : A Review Plant Fiber Reinforced Polymer Matrix Composites : A Review,” no. October 2017, 2017.

- [33] P. Ranga, S. Singhal, and I. Singh, "A Review Paper on Natural Fiber Reinforced Composite," vol. 3, no. 2, pp. 467–469, 2014.
- [34] M. S. Bodur, M. Bakkal, M. Savas, and O. B. Berkalp, "A new approach for the development of textile waste cotton reinforced composites (T-FRP): Laminated hybridization vs. coupling agents," *J. Polym. Eng.*, vol. 34, no. 7, pp. 639–648, 2014, doi: 10.1515/polyeng-2013-0281.
- [35] P. S. Souza, E. F. Rodrigues, J. M. C. Prêta, S. A. S. Goulart, and D. R. Mulinari, "Mechanical properties of HDPE/textile fibers composites," *Procedia Eng.*, vol. 10, pp. 2040–2045, 2011, doi: 10.1016/j.proeng.2011.04.338.
- [36] A. Mohd, N. Bahiyah Baba, M. Z. Umor, and R. M. Mohamed, "Composites of Polymer Blends and Their Applications Using Natural Fibres: A Review," *IOP Conf. Ser. Mater. Sci. Eng.*, vol. 1068, no. 1, p. 012006, 2021, doi: 10.1088/1757-899x/1068/1/012006.
- [37] K. Rukmini, B. Ramaraj, S. K. Shetty, A. Taraiya, S. Bandyopadhyay, and Siddaramaiah, "Development of eco-friendly cotton fabric reinforced polypropylene composites: Mechanical, thermal, and morphological properties," *Adv. Polym. Technol.*, vol. 32, no. 1, pp. 1–9, 2013, doi: 10.1002/adv.21327.
- [38] T. Hobbs and A. J. Lesser, "Preparation of high performance poly(ethylene terephthalate) fibers: Two-stage drawing using high pressure CO<sub>2</sub>," *Polymer (Guildf.)*, vol. 41, no. 16, pp. 6223–6230, 2000, doi: 10.1016/S0032-3861(99)00849-6.
- [39] X. Si, L. Guo, Y. Wang, and K. tak Lau, "Preparation and study of polypropylene/polyethylene terephthalate composite fibres," *Compos. Sci. Technol.*, vol. 68, no. 14, pp. 2943–2947, 2008, doi: 10.1016/j.compscitech.2007.11.008.
- [40] R. C. Nonato and B. C. Bonse, "A study of PP/PET composites: Factorial design, mechanical and thermal properties," *Polym. Test.*, vol. 56, pp. 167–173, 2016, doi: 10.1016/j.polymertesting.2016.10.005.
- [41] M. Arroyo and M. A. López-Manchado, "Effect to the incorporation of pet fibers on the properties of thermoplastics elastomer based on PP/elastomer blends," *Polymer (Guildf.)*, vol. 42, pp. 6557–6563, 2001.
- [42] M. F. Lai, J. Li, and J. J. Liu, "Thermal and dynamic mechanical properties of poly(propylene carbonate)," *J. Therm. Anal. Calorim.*, vol. 82, no. 2, pp. 293–298, 2005, doi: 10.1007/s10973-005-0892-2.
- [43] P. Santos and S. H. Pezzin, "Mechanical properties of polypropylene reinforced

- with recycled-pet fibres,” *J. Mater. Process. Technol.*, vol. 143–144, no. 1, pp. 517–520, 2003, doi: 10.1016/S0924-0136(03)00391-1.
- [44] A. H. Youssef, M. R. Ismail, M. A. M. Ali, and A. H. Zahran, “Studies on sugarcane bagasse fiber-thermoplastics composites,” *J. Elastomers Plast.*, vol. 41, no. 3, pp. 245–262, 2009, doi: 10.1177/0095244308095014.
- [45] P. N. Khanam and M. A. A. AlMaadeed, “Processing and characterization of polyethylene-based composites,” *Adv. Manuf. Polym. Compos. Sci.*, vol. 1, no. 2, pp. 63–79, 2015, doi: 10.1179/2055035915Y.0000000002.
- [46] R. Várdai *et al.*, “Reinforcement of PP with polymer fibers: Effect of matrix characteristics, fiber type and interfacial adhesion,” *Polymer (Guildf.)*, vol. 190, 2020, doi: 10.1016/j.polymer.2020.122203.
- [47] C. Fiber *et al.*, “Polypropylene Composite Polymer Matrix Composites : Applications,” 2018.
- [48] A. P. Gupta and A. Alam, “Study of Flexural, Tensile, Impact properties and Morphology of Potato Starch/Polypropylene blends,” *Int. J. Adv. Res.*, vol. 2, no. 11, pp. 599–604, 2014, [Online]. Available: <http://www.journalijar.com>.
- [49] M. Alejandra Costantino, C. Rosales, and V. Pettarin, “Polypropylene Blends and Composite: Processing-Morphology-Performance Relationship of Injected Pieces,” *Polypropyl. - Polym. Charact. Mech. Therm. Prop.*, 2020, doi: 10.5772/intechopen.85634.
- [50] C. Saujanya and S. Radhakrishnan, “Structure development and properties of PET fibre filled PP composites,” *Polymer (Guildf.)*, vol. 42, no. 10, pp. 4537–4548, 2001, doi: 10.1016/S0032-3861(00)00860-0.
- [51] S. Houshyar, R. A. Shanks, and A. Hodzic, “The effect of fiber concentration on mechanical and thermal properties of fiber-reinforced polypropylene composites,” *J. Appl. Polym. Sci.*, vol. 96, no. 6, pp. 2260–2272, 2005, doi: 10.1002/app.20874.
- [52] Y. W. Leong, M. B. Abu Bakar, Z. A. M. Ishak, A. Ariffin, and B. Pukanszky, “Comparison of the mechanical properties and interfacial interactions between talc, kaolin, and calcium carbonate filled polypropylene composites,” *J. Appl. Polym. Sci.*, vol. 91, no. 5, pp. 3315–3326, 2004, doi: 10.1002/app.13542.
- [53] S. N. M. Bakhori, M. Z. Hassan, A. A. Sa’ardin, S. H. S. M. Fadzulah, and F. Ahmad, “Tensile properties of jute-polypropylene composites,” *Chem. Eng. Trans.*, vol. 63, pp. 727–732, 2018, doi: 10.3303/CET1863122.
- [54] N. J. Lee and J. Jang, “Effect of fibre content on the mechanical properties of glass



- fibre mat/polypropylene composites,” *Compos. Part A Appl. Sci. Manuf.*, vol. 30, no. 6, pp. 815–822, 1999, doi: 10.1016/S1359-835X(98)00185-7.
- [55] M. Tausif, A. Pliakas, T. O’Haire, P. Goswami, and S. J. Russell, “Mechanical properties of nonwoven reinforced thermoplastic polyurethane composites,” *Materials (Basel)*., vol. 10, no. 6, 2017, doi: 10.3390/ma10060618.