



TALLINNA TEHNIKAÜLIKOOL  
TALLINN UNIVERSITY OF TECHNOLOGY

Department of Materials and Environmental  
Technology

## Optimization of electrospinning parameters on PVDF nanofiber membrane preparation

Elektroketruse parameetrite optimeerimine nanokiuliste PVDF  
membraanide valmistamisel

MASTER THESIS

Student: Mihhail Krõlov

Student code 163060 KVEM

Supervisor: Mihkel Viirsalu, engineer

Tallinn 2018

## AUTHOR'S DECLARATION

Hereby I declare, that I have written this thesis independently.

No academic degree has been applied for based on this material. All works, major viewpoints and data of the other authors used in this thesis have been referenced.

"31" May 2018

Author: .....

*/signature /*

Thesis is in accordance with terms and requirements

"31" May 2018

Supervisor: .....

*/signature/*

Accepted for defense

"31" May 2018

Chairman of theses defence commission: .....

*/name and signature/*

Department of Materials and Environmental Technology  
**THESIS TASK**

**Student:** Mihhail Krõlov, 163060 KVEM

Study program: KVEM, Technology of Wood, Plastic and Textiles

main specialty: Technology of Plastics and Textiles

Supervisor(s): TUT, Department of Materials and Environmental Technology, engineer, Mihkel Viirsalu, +37258364111

**Thesis topic:**

(in English) Optimization of electrospinning parameters on PVDF nanofiber membrane preparation

(in Estonian) Elektroketruse parameetrite optimeerimine nanokiuliste PVDF membraanide valmistamisel

**Thesis main objectives:**

1. Optimization of different electrospinning parameters to find the most productive combination for PVDF nanofibrous membrane preparation.
2. Utilizing the optimized electrospinning parameters in PVDF nanofiber yarn preparation.

**Thesis tasks and time schedule:**

No	Task description	Deadline
1.	Electrospinning of PVDF membrane	05.10.17
2.	Characterization of PVDF membrane	26.11.17
3.	PVDF electrospinning implementation in yarn spinning	22.12.17

**Language:** English **Deadline for submission of thesis:** "31" May 2018

**Student:** Mihhail Krõlov ..... "31" May 2018  
/signature/

**Supervisor:** Mihkel Viirsalu ..... "31" May 2018  
/signature/

## Contents

Table of figures.....	5
List of abbreviations.....	6
INTRODUCTION .....	7
1 LITERATURE REVIEW .....	8
1.1 Nanofiber preparation .....	9
1.2 Characterization.....	19
2 EXPERIMENTAL PART .....	24
3 RESULTS AND DISCUSSIONS .....	35
4 CONCLUSIONS .....	46
SUMMARY .....	48
REFERENCES .....	49
APPENDIX .....	52

## Table of figures

Figure 1 Non-piezoelectric and piezoelectric crystalline structures.....	8
Figure 2 Schematic of electrospinning process. ....	10
Figure 3 Jet initiation stages.....	11
Figure 4 Used electrospinning setup schematic. ....	12
Figure 5 General effect of increasing voltage on electrospinning process and fiber diameter..	13
Figure 6 Needle diameter.....	15
Figure 7 Principles of electro spraying .....	16
Figure 8 Schematic of coating the yarn filament with nanofibers. ....	17
Figure 9 Schematic of probe-type sonicator.....	18
Figure 10 Schematic of Scanning electron microscope.....	20
Figure 11 Schematic of FTIR machine working principle. ....	22
Figure 12 Schematic of tensile test machine. ....	23
Figure 13 PVDF pellet container.....	24
Figure 14 Electrospinning set up.....	25
Figure 15 Solution preparation procedure.....	26
Figure 16 Solution droplet during the ES. ....	28
Figure 17 Double-pump setup schematic. ....	31
Figure 18 Electrospun PVDF solutions observed by SEM.....	35
Figure 19 Electrospun PVDF solutions for 3 hours observed by SEM. ....	36
Figure 20 PVDF membrane produced by double pump ES. ....	37
Figure 21 Yarn ES with different yarn types.....	39
Figure 22 FTIR spectra of prepared samples.....	40
Figure 23 Comparison of pure PVDF and electrospun PVDF. ....	42
Figure 24 Behavior of the material during the test.....	43
Figure 25 Comparison of tensile tests results .....	44

## List of abbreviations

PVDF – Polyvinylidene fluoride

DMF – Dimethylformamid

FS – Fluorosurfactant

SEM – Scanning electron microscopy

FTIR - Fourier-transform infrared spectroscopy

TEP – Triethyl phosphate

DMS – Dimethyl sulfide

DMSO – Dimethyl sulfoxide

DMAc – Dimethylacetamid

NMP – N-methyl-2-pyrrolidone

## INTRODUCTION

The aim of this thesis is to find proper conditions to produce Polyvinylidene fluoride (PVDF) electrospun membranes. Developed method will be further used in yarn electrospinning (ES). PVDF is a highly non-reactive thermoplastic fluoropolymer produced by the polymerization of vinylidene difluoride. Properties of PVDF allow it to be used as insulation on electric wires. PVDF posses a lot of useful properties like flexibility, low weight as well as low thermal conductivity. It also has high chemical corrosion and heat resistance. These properties allow PVDF to be used as insulation on electric wires. PVDF insulation is used for narrow 0.25 mm wires. Most of them are used in wire wrap circuit assembly and printed circuit board rework [1]. The goal of this work was to develop the most suitable method to prepare the solution and set up the electrospinning equipment.

Acquired material will be investigated for the fibers morphology and physical properties, in order to conclude the most effective way to create PVDF membranes. The resulting data will be further used to set up the yarn electrospinning.

Successful production of such yarn may be followed by practical implication of this material. There are various ways for it to be used in modern days. Such compact technology with high energy outcome can be implemented not only for trivial electrical sources, as example mobile phone's battery. But can be used in powering different kind of military equipment that required sufficient and constant power supply without disturbing the compatibility of other equipment.

# 1 LITERATURE REVIEW

## Piezoelectricity

The PVDF is used due to its piezoelectric properties. Piezoelectricity is the generation of electric field from applied pressure. It is observed in crystalline materials with no inversion symmetry. In piezoelectric materials the positive and negative charges are symmetrically distributed in a crystal. In order to achieve such properties most of the materials have to be polarized from random orientation to symmetrical. When pressure is applied to an object, a negative charge is produced on the expanded side and a positive charge on the compressed side. Once the pressure is relieved, electrical current flows across the material. Due to intense growth of nanotechnologies, piezoelectric materials have more use than ever before. Investigations in this area are being carried out more frequently. There are different applications for such materials. Not only it is used in military in micro robotics, it is used in every kind of devices, like headphones, printers, sonar equipment, pressure sensors. [1]

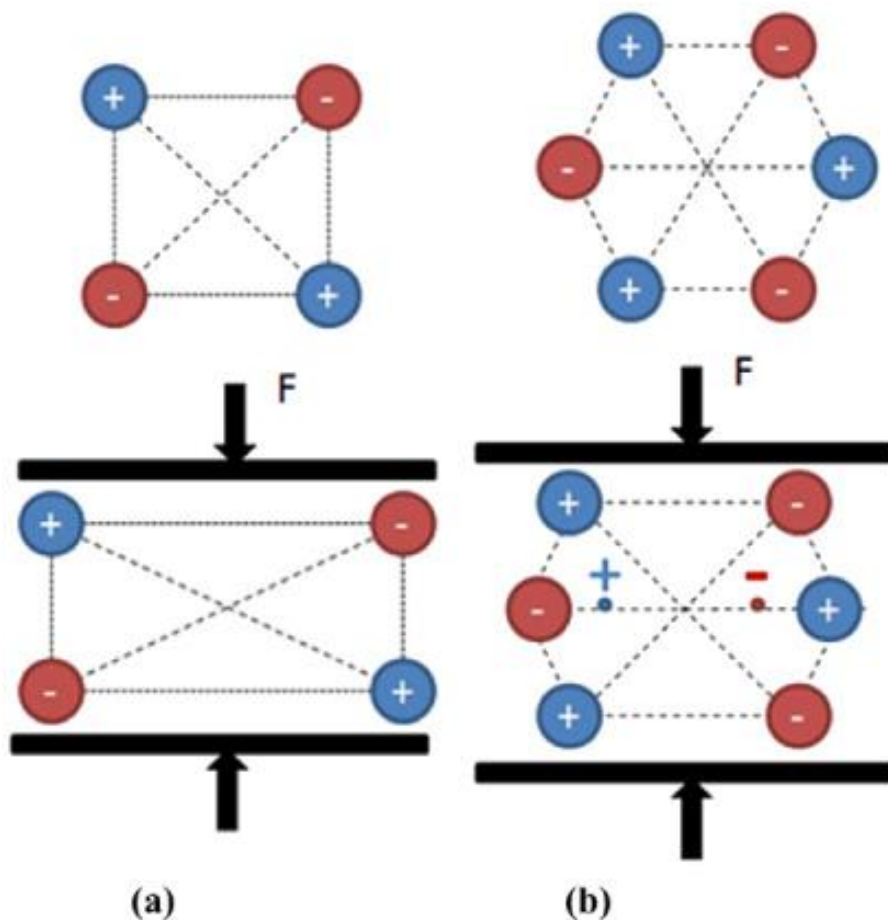

Figure 1 Non-piezoelectric (a) and piezoelectric (b) crystalline structures. [2]



The Figure 1 presents the principle of electric charge acquirement by applying force on the polymeric material. For the square orientation (a) input stress does not change the center of charge of the positive and negative ions. For the hexagon structure, the center of the charge of the negative and positive ions is changed due to the applied force, that means that polarization was changed. [2]

### **PVDF dissolvent**

PVDF can be electrospun with various solvents. Most of them are toxic, thus hazardous for health. Triethyl phosphate (TEP) is a green solvent and is safer to use, but it does not match the properties of other solvents (solubility, polarity, viscosity, boiling point) like Dimethyl sulfide (DMS), dimethyl sulfoxide (DMSO), dimethylacetamid (DMAc), N-methyl-2-pyrrolidone (NMP). Even though DMSO is less toxic than dimethylformamid (DMF) and in long-term membrane production it is better to use, in this project DMF will be the solvent, as it is more effective for testing due to its lower vapor pressure. [3]

Still, if only DMF is used as solvent for PVDF, then this solution cannot be electrospun. Therefore acetone is added to the mixture, so that Taylor cone be achieved during the ES following with continous elongation of the fibers and their accumulation on the collector, while the solvents are evaporated.

## **1.1 Nanofiber preparation**

### **Electrospinning**

Electrospinning is a process of acquiring ultrathin fibers and the following products of it by applying electrostatic field created by power supply. Under the influence of electric filed the fluid may elongate into thin fiber.

The way the electrospinning is known now was discovered in 1902 by Morton and Cooley [4, 5]. After them, investigations in this technique was implemented by Formhals, following by obtaining nine patents identifying main possibilities to optimize the electrospinning process [6]. Unfortunately, technologies of that time were limited, thus the potential of nanofibers could not be reached. Use of electrospinning started to grow in 1995 when the nanotechnologies became more popular and easier to develop. With usage of Scanning electron microscope that was commonly available at that time, the properties of nanofibers were investigated as well as potential fields of use were evaluated, pushing the electrospinning

process to be used by larger amount of scientist. Responsible for re-introducing the electrospinning to the world were Doshi and Reneker. [7]

Working principles of electrospinning process are as follows (see Fig.2). The liquid has to be inserted into capillary. The capillary has to be in contact with high voltage power supply. Due to the difference between the potential of charged spinneret and grounded collector the fiber will be elongated. If the liquid presents a polymer solution with easily evaporable solvent, then after solvent evaporation a thin yarn will be left. The outcome can be influenced by changing the solution preparation conditions as well as electrospinning station parameters. [8]

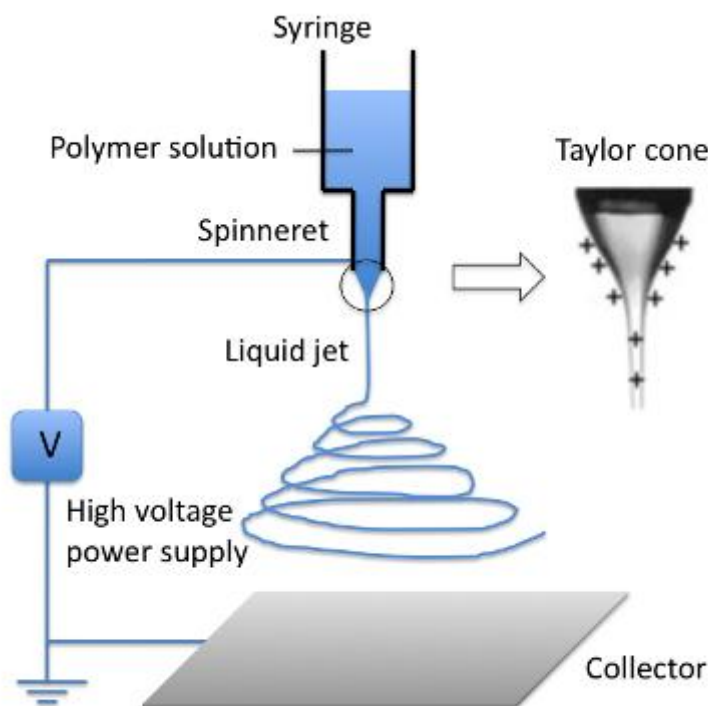

Figure 2 Schematic of electrospinning process. [9]

Figure 2 shows the principle of electrospinning process working: appliance of high voltage on the spinneret, accumulation of Taylor cone and followed jet being elongated and deposited on the collector. For this work drum collector was used, as it allows to obtain thicker membrane with more uniform fiber distribution.

Spinneret is connected to a syringe which supplies the polymer solution that can be fed through a spinneret at a constant rate using the syringe pump. Application of the high voltage results in statically charging the drop of the polymer solution at the nozzle of the spinneret. The accumulation of charges causes the distortion of the droplet into a conical shape known as

Taylor cone. Due to the increase of the electrostatic field's strength, the surface tension of the polymer is overcome by electrostatic force and charged jet of fluid is ejected from the tip of the Taylor cone. The jet undergoes a stretching and whipping process which results in formation of thin thread. Evaporation of the solvent during the flight develops the formation of nanoscale fiber that is accumulated on the grounded collector. [10]

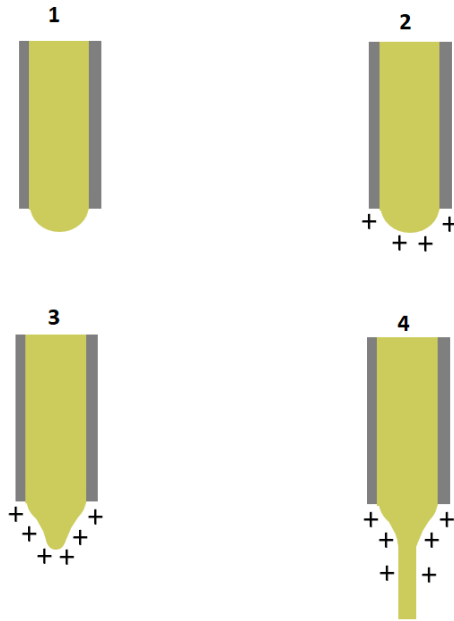

Figure 3 Jet initiation stages. [11]

The initiation steps of the Taylor cone formation with further elongation of the polymer are presented on Figure 3. At stage 1 the drop of the solution partly exits the needle by the applied pressure from the pump. Stage 2 starts with application of the high voltage. Due to that, concentration of the charges around the tip of the solution is rising, therefore it has the largest curvature. Stage 3 proceeds with increased density of the charges and increased applied voltage. The solution drop starts to contort. At stage 4 applied voltage achieves a critical value and density of the charges on the tip of the drop is high enough to overcome the surface tension of the solution. Therefore the polymer jet is ejected from the tip of the Taylor cone. [11]

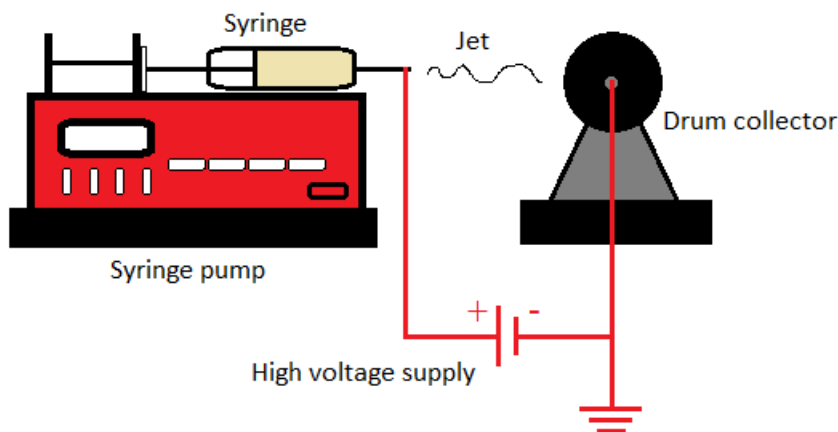

Figure 4 Used electrospinning setup schematic.

Figure 4 presents the electrospinning setup that was used during this work. Solution was supplied by the syringe. Syringe pump allowed the feed the polymer solution at a constant rate. Needle of the syringe was connected to the high voltage power supply. The polymer jet acquired by the ES was landed on the grounded drum collector.

Working with electrospinning setup is a delicate procedure, as it is dangerous to interfere within the chamber during the spinning, due to high voltage inside the chamber. Also, as many solutions have hazardous solvents, opening the chamber without stopping the process is inappropriate. Vaporized solvent may contact with skin causing further problems, as well as the fibers themselves, might be attracted on the skin, some of which may still contain solvent residues which are not evaporated.

The electrospinning process may be influenced by different variables like solution viscosity, conductivity, applied voltage etc.

### **Solution viscosity**

Viscosity is the internal friction of a fluid. It is property of fluid to resist movement of its one part relatively to its other part. In electrospinning solutions with high viscosity result in fibers with greater diameters. Reducing the viscosity will reduce the fibers diameter but, nevertheless, too low viscosity will result in beaded fibers, thus this parameter has to be optimized for proper electrospinning conditions. [12]

## Solution conductivity

Another way to reduce fibers diameter is to increase the solution conductivity. With higher amount of charge carriers stretching of electrospinning jet will be better. Optimized conductivity also results in reducing the solutions surface tension which leads to less required force to overcome it. The mainly used methods to increase solution conductivity is using more conductive solvent. [12]

## Voltage

Increase in applied voltage may result in reducing the fibers diameter, as the stretching of electrospinning jet is determined by presence of the charges on the jet within the electric field. Still, if the voltage is higher of an optimal level, the flight time of the jet will decrease, resulting in higher fibers diameter due to poor stretching (see Fig. 5). [13]

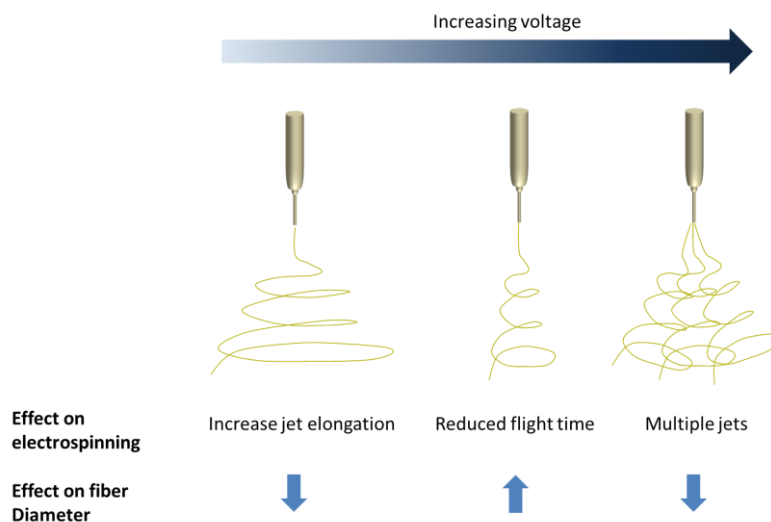

Figure 5 General effect of increasing voltage on electrospinning process and fiber diameter. [14]

If the voltage is further increased during the electrospinning, multiple jets can appear with different diameters. That creates big deviation in fiber's diameters as well as uneven spreading of the fiber over the collector material. If the polymer jet was broken into small portions, and electrically charged droplets are being attracted to the collector, then this phenomenon is call electrospaying. Therefore, careful manipulation over the applied voltage is necessary to achieve fine fibers.

### **Needle distance from collector**

Proper distance between the tip of the needle and the collector is required to find balance between electric field strong enough to overcome solutions surface tension and electrospinning jet to have better stretching. In case of the distance being over the required value, electric field strength will be weakened, resulting in fibers diameter increase. [15]

### **Humidity of the spinning environment**

In case of humidity factor, there cannot be applied a certain dependency for all the polymers used in electrospinning. As for some of them high relative humidity may result in increasing fibers diameter by rapid precipitation of the polymer as well as in decreasing fibers diameter by better water absorption that leads to reduced concentration and viscosity. However in some cases diameter increase may be caused by lower humidity level, as the solvent starts to evaporate faster, thus solidification rate increases. Diameter decrease was also reported with lower humidity, that can be explained by reduction in precipitation effect. Therefore, humidity effect must always be tested during the electrospinning whether it is reducing or increasing fibers diameter with higher or lower level. [16]

### **Nozzle diameter**

Nozzle diameter varying affects the size of Taylor cone. If it is big, then the jet diameter will also be larger. In order to reduce the fibers diameter it is reasonable to use smaller nozzles, as the amount of solution being able to pass through it will be smaller. Still this parameter has to be optimized relating on other parameters. [17]

Needle section is presented on Figure 6. For the electrospinning the inner diameter is necessary to know. A lot of different calculations regarding the feed rate depend on the needle diameter, therefore the correct value has to be taken into account. The figure shows that the outer diameter of the needle is 0.8 mm, yet the inner diameter is 0.5 mm. For this specific work, needles with inner diameter of 0.5 mm were used. This parameter was not changed in order to prevent possible inconsistencies in the resulted fibers diameters.

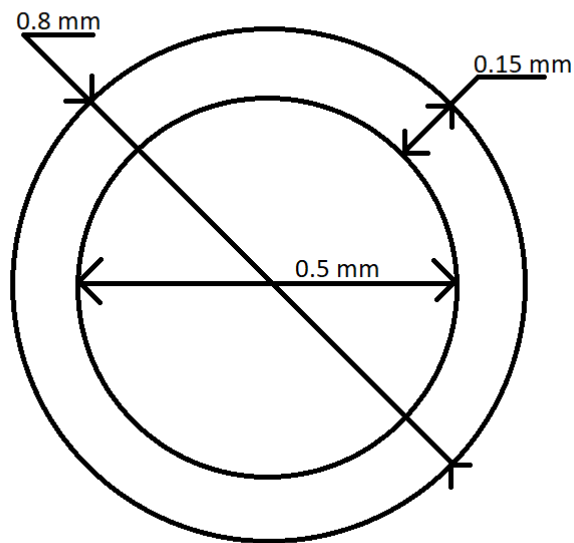

Figure 6 Needle diameter.

### **Solution feed rate**

Feed rate is required to be optimized in order to find proper electrospinning conditions. The amount of solution exiting the nozzle affects the fibers diameter. The electric field has to be powerful enough to stretch the jet. In case of feed rate higher than normal, amount of solution will be too big to have enough solvent vaporized during flight time, leading to big fiber diameter as well as possible fibers structure inconsistencies. [18]

### **Electrospray**

Electrospraying principle is similar to the conventional electrospinning. The setup consists of the same equipment [see Fig. 7]. The difference is that electrospinning produces nanoscale fibers and electrospray is used to create thin films.

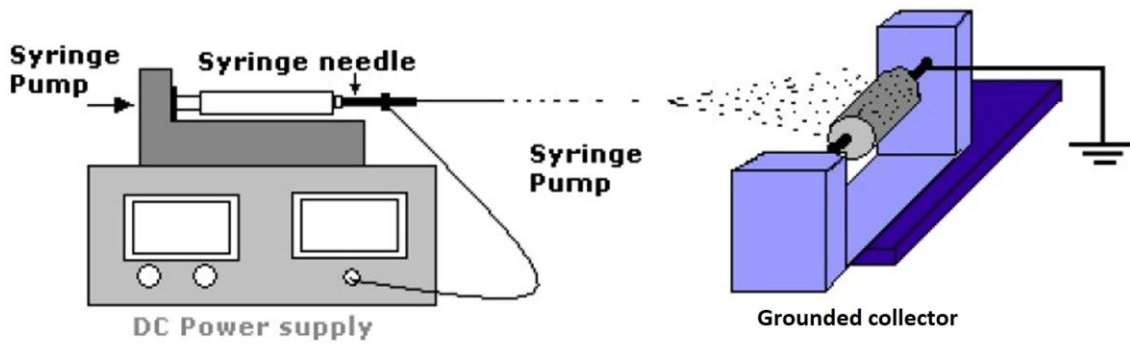

Figure 7 Principles of electrospaying. [18]

Usually, the polymer jet can be broken up into smaller droplets if the solvent is relatively volatile, thus the evaporation of which lead to the shrinkage of the droplets and an increase in excess charge density. Using conventional ES, the jet can be turned into the spray if used voltage is too high. Also low solution concentration and low molecular weight of the polymer can cause the electrospay, therefore PVDF of higher molecular mass is used. As the goal of this work is to obtain successfully electrospun fibers that create a membrane, occurrence of the electrospaying is unacceptable; therefore manipulation of ES parameters is limited. [19]

## Yarn electrospinning

The idea of yarn electrospinning emerged from the ability of electrospinning jet to self-bundle. This effect occurs when charge carriers approach the grounded collector, therefore they are discharged, thus the neutral fibers start to attract the charged ones. It is possible to use differently charged electrospinning jets that results in positive and negative segments to be attracted to each other. Unfortunately, such method results in poor fibers properties, as there is not enough time for stretching when jet collide mid-flight, also beads are occurring on the membrane, as well as collecting continuous strand of yarn is challenging. [20]

One way to collect the continuous yarn is to use micro-filament that will go through the electrospinning chamber (see Fig.8). The chamber itself has cylindrical form with ventilators on top of it and on the bottom. Side of the chamber has slight opening for the air to enter. Upper ventilators extract air from the chamber, thus creating the vortex inside as the incoming air is moving from the side to the top. Lower ventilator is also affecting the air movement inside the chamber by supplying air on the bottom part of the chamber, thus air movement speed is different on two parts of chamber. That is useful for the incoming jets to stay in air for a longer time in order to let the solvent evaporate. There are two spinnerets on the opposing sides of



chamber. Solutions are positively and negatively charged for the bundling effect to occur. The microfilament is poured through the middle of the chamber perpendicular to the jet income positions, and is drawn by the drum collector. The fibers are led by the vortex onto the filament yarn as well as differently charged jets are being attracted to one another. On the way out of chamber the yarn passes through thin hole that supports better alignment of nanofibers on the yarn. [21]

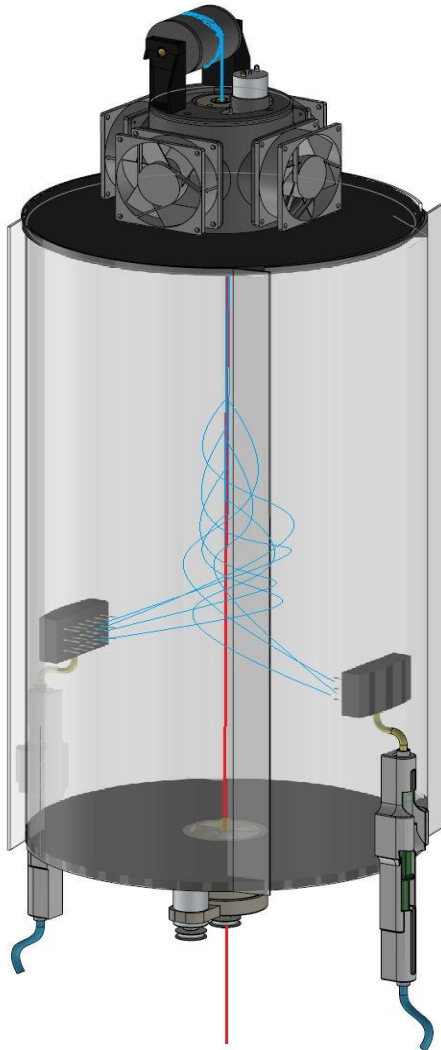

Figure 8 Schematic of coating the yarn filament with nanofibers.

## Sonication

Ultrasound sonication is used for various purposes, in this work, the aim of using this method was to improve the rheological properties of the solutions, increase their electric conductivity and reduce surface tension. Occurring effect by using ultra sonication is called cavitation (see Fig. 9). The sound waves are transmitted into the fluid medium by using high power

ultrasound, thus creating high-pressure and low-pressure cycles. During low-pressure cycle small vacuum bubbles are created in the liquid by high-intensity ultrasonic waves. Bubble collapse during a high-pressure cycle when the amount of energy obtained can no longer be absorbed. [22]

There are two types of sonicators used: ultrasonic bath and probe-type sonicator.

Ultrasonic baths are used mainly for cleaning applications, due to the fact that cavitation occurs uncontrollably through the tank. Sonication effect has low intensity and is unevenly spread. [23]

Probe-type ultrasonicator was found to have a high localized intensity compared to water bath type. That means higher efficiency of sonication process. With probe device the sonication zone is straight below the probe. Irradiation range is confined to a particular area of the probe's tip. [23]

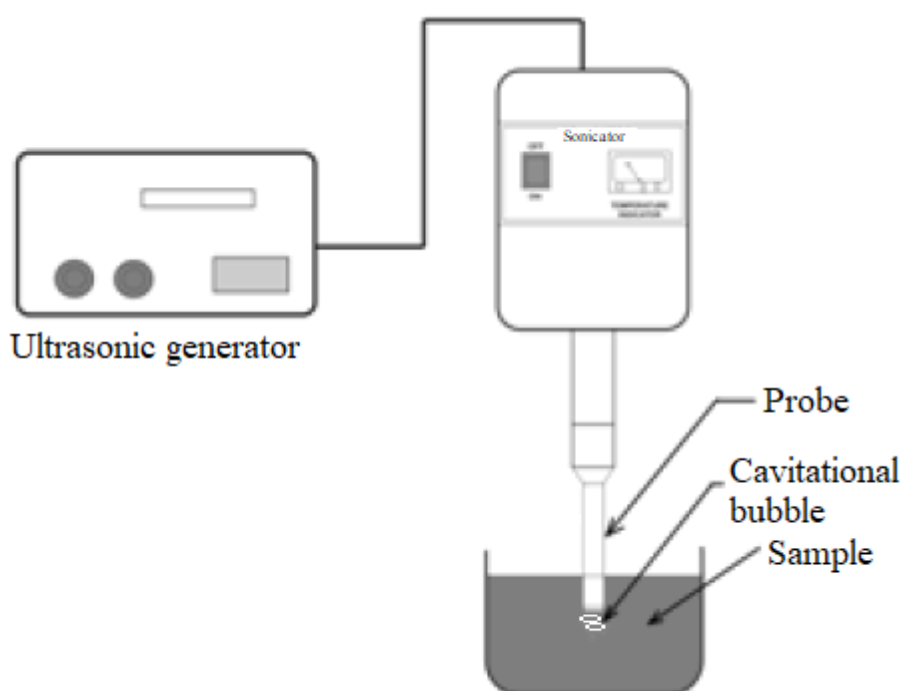

Figure 9 Schematic of probe-type sonicator. [24]

As the probe sonicator shows better results in strong sonication effect and better controlled process, it will be used in this work.

## 1.2 Characterization

### Scanning electron microscope

Scanning electron microscope (SEM) is a type of electron microscope that is used to acquire image of object's surface with high resolution. Its work is based on applying a beam of electrons.

Optical microscopes are limited by the wavelength of light that is 0.1-0.2  $\mu\text{m}$ . In nanoscale this is not enough. The wavelength has to be shorter to see thinner details. Electrons, whose wavelengths are much shorter can be used for that purpose, leading to emerging of electron microscopes. [25]

The working principle of SEM (see Fig. 10) is that focused beam of electrons is emitted from the electron gun. Anode attracts the electrons to form a beam. Their path is being directed by the magnetic lens. Scanning coils are used to deflect the already focused beam in X and Y axes in order to provide finest scanning over the surface of the sample. Electrons are further applied on the analyzed sample, resulting in generation of secondary electrons that are collected on the secondary electron detectors. The received information creates the high resolution image of object's surface.

The signals used by SEM to produce image appear from interaction of the electron beam with atoms at depths within the sample. Various types of signals are generated by this interaction: secondary electrons, back-scattered electrons, characteristic X-rays and light, absorbed current and transmitted electrons.

Interaction between the sample's atoms and beam's electrons result in transferring part of energy to the sample's electrons, leading to the possible electron separation. Such electrons possess small amount of energy, usually one electron of initial beam has enough energy to produce few secondary electrons. Due to low energy of secondary electrons their release is possible only from surface layers of the materials (10 nm).

Mainly, there are various types of detectors in SEM in order to analyze different signals. But for acquiring sample's surface image secondary and back-scattered electron signals are used. Secondary electrons provide more consistent information of surface, whether back-scattered electrons detectors can provide information about sample's composition. Using back scatter

electron detector allows for lower vacuum levels, reducing sample preparation requirements and minimizing beam damage. [26]

This work requires information about the fibers morphology, meaning the SEM is very well convenient tool to analyze this property. Fibers dispersion and bead appearance can be evaluated as well as fibers diameters can be measured.

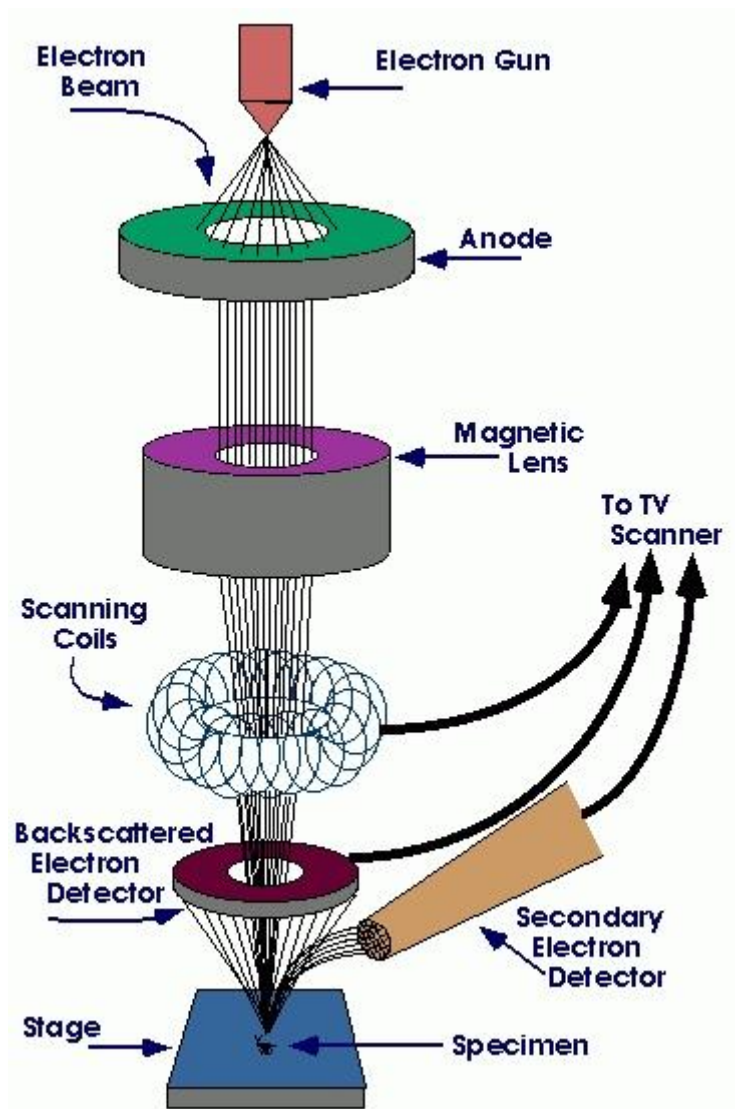

Figure 10 Schematic of Scanning electron microscope. [27]

One thing to be considered about SEM is sample preparation. Some samples required coating to make them conductive. Such procedure is not needed for metals due to their ability to conduct electricity. Usually, for non-metal materials a thin layer of gold is used. The used materials in this work do possess conductive properties, thus coating is not required. Nevertheless, working with samples is very delicate, as there cannot be any extra elements to be accumulated on the surface as it could disturb the desired image during observations. As

the observation process is being carried out in high vacuum environment, sample has to be totally dry. Otherwise, water vaporization will obstruct the electron beam and affect the image.

### **FTIR spectroscopy**

Fourier-transform infrared (FTIR) spectroscopy is a method to obtain an infrared (IR) spectrum of absorption or emission of a solid, liquid or gas. Previously used dispersive instruments had their limitations in slow scanning process as every infrared frequency was measured individually. Device that produces unique type of signal which has all of the infrared frequencies was developed and called interferometer. Its signal can be measured in few seconds. During the IR radiation passing through the sample, some radiation is absorbed by the sample and some passes through. The data collected on the detector presents the molecular “fingerprint” of a sample. As different molecules can produce different spectra, this approach is suitable in order to understand chemical structure of an object. [28, 29]

First of all, the background spectra has to be measured, it is a simple measurement without a sample. Comparing it to the measured sample the percent transmittance can be determined. Background spectra is characteristic of the instrument itself, thus it can be used for various samples providing information of the sample properties only.

Light emitted from the source is split by beam splitter and goes to stationary mirror and moving mirror, after what beams go back to the beam splitter (see Fig. 11). These two beams recombine, resulting in constructive and destructive interference by the path length difference. The resulting signal is called an interferogram which has the information about every infrared frequency that comes from the source. So that all frequencies are measured simultaneously when interferogram is measured. In order to receive the spectra of a sample the measured interferogram signal has to be decoded. Fourier transformation technique is used for that and can be performed by a computer. [28, 29]

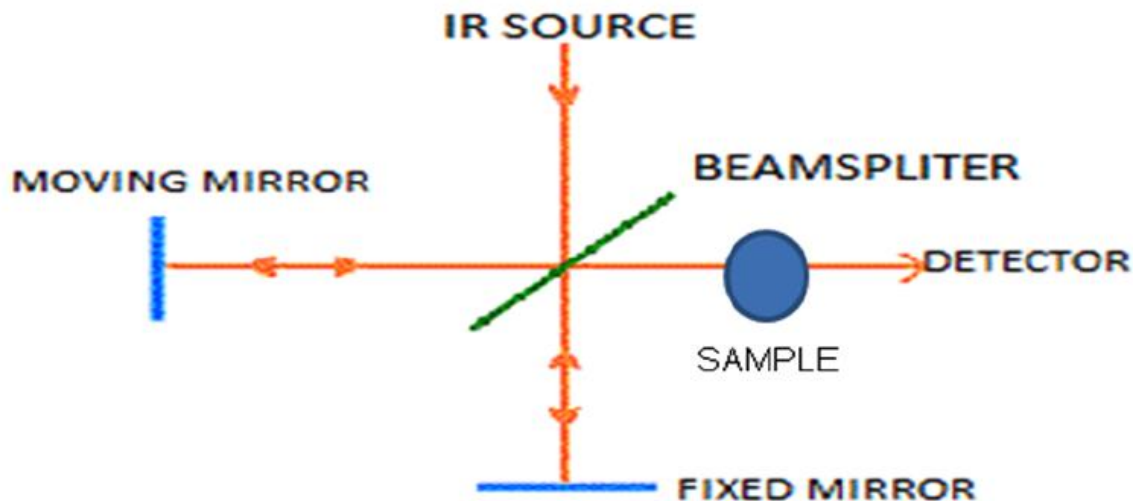

Figure 11 Schematic of FTIR machine working principle. [30]

There are many advantages of FTIR spectroscopy. The operating speed is high, as all the frequencies are measured simultaneously. Detectors sensitivity is very high resulting in lower noise levels, fast speed of scans can also allow to have various measurements in short time in order to reduce randomly measured noise. As the moving mirror is the only moving part in the instrument, the probability of mechanical break is very low.

Sample preparation for FTIR analysis is also not a complex process. For liquids small drop of the solution must be placed on the plate then put into the sample holder. After being scanned, plate has to be thoroughly cleaned and washed with ethanol. This technique is applicable for solids as well, but the sample has to be placed more carefully, in order to avoid any void area between the sample and sample holder, that would result in inconsistent spectra. [29]

### Tensile test

Tension test is the most used type of mechanical tests that can be performed on material. This test allows to understand how will certain material react to applied force in tension, providing information about material's strength and how much it can elongate.

For most materials under tension, the relationship between the applied force and the elongation of the specimen is linear in the initial step of test. Hook's law is applied to lines that are in linear region where the ratio of stress and to strain is a constant. If the sample is loaded within linear region, then the material will return to its initial position after the load is eliminated. If the applied force has overcome the linear region, then Hook's law no longer

applies and some constant deformation takes place in the sample. The testing specimen remains under the increasing load till the point of failure. [31]

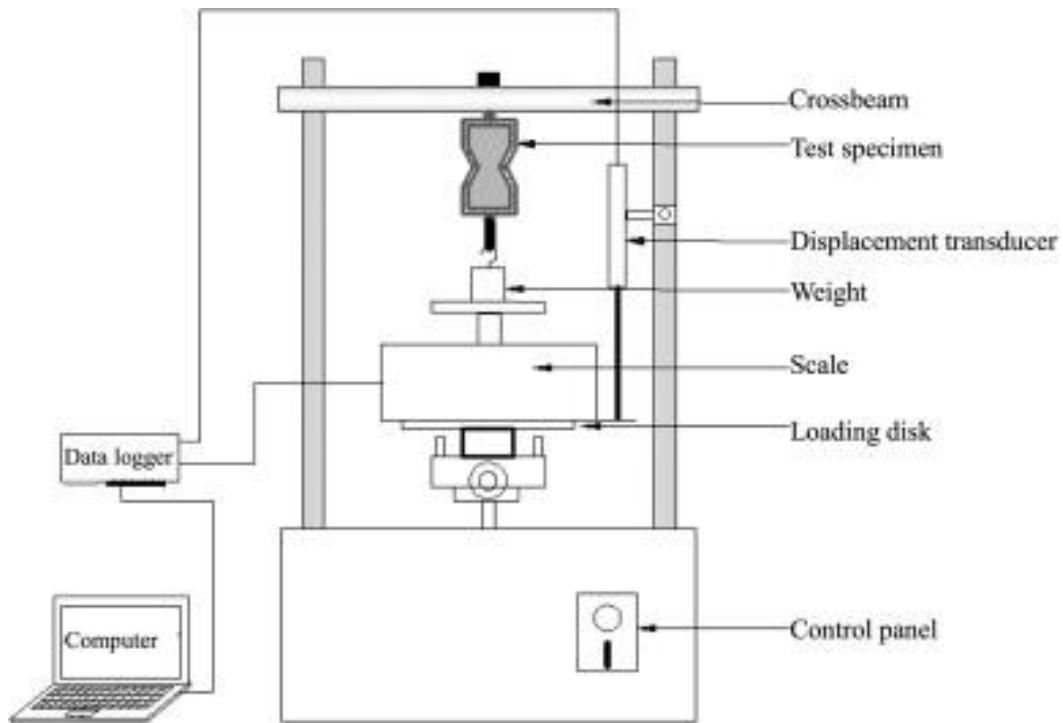

Figure 12 Schematic of tensile test machine. [32]

The test sample is placed in the machine and is being held by top and bottom grips attached to the crossbeam and weighted part of the testing machine (see Fig. 12). Grips are moved apart at constant rate during the tension test in order to pull and stretch the specimen. Moving of the grips is conducted by the loading disc displacement. The process is continuously monitored as the deformation of the specimen and applied force are recorded by displacement transducer. All the acquired data is later transferred to the computer software by the data logger and is converted into easy readable graph. [31, 33]

## 2 EXPERIMENTAL PART

### Materials

The PVDF with molar mass 530000 g/mol (PVDF-530) from Sigma–Aldrich was used (see Fig. 13). The solvents used were N,N-dimethylformamide (DMF, Merck 99.5%) and acetone (Merck, 99.7%). Fluorosurfactant (FS) of anionic type Capstone FS-66 was purchased from Sigma–Aldrich.



Figure 13 PVDF pellet container.

### Electrospinning

The initial used parameters for solution preparation were same as described in article [3]. Thus the initial concentration of PVDF was 16% with DMF/acetone solvent ratio 2:3 respectively.



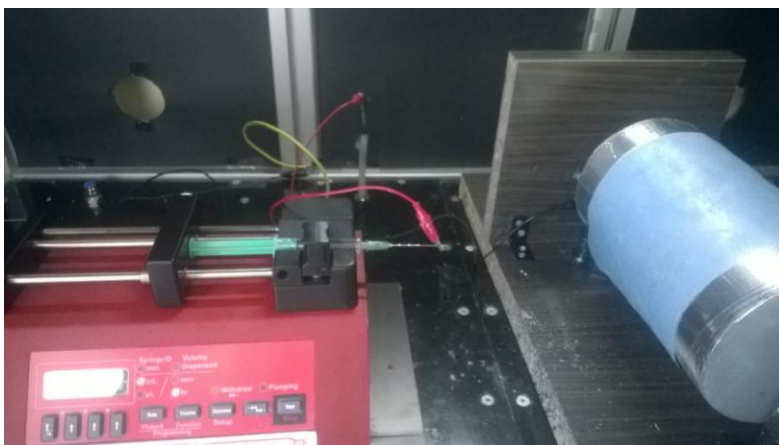

Figure 14 Electrospinning set up.

Figure 14 present how the syringe was connected to the power supply, as well as the equipment that was earlier showed on the Figure 2. The power supply is connected to the tip of the needle by crocodile clip cable. The similar cable is used to ground the collector. The pump has the ability to manipulate the feed rate at different values, as well as cooperating the pumping speed with different syringe diameter used.

First prepared solution changed color to yellow, which suggests that the solution was oxidized. Therefore the new solution was immediately prepared cautiously.

After adding the components, solution was held in water bath at  $45\text{ C}^0$  for 5 hours, during the mechanical stirring, to accelerate dissolving. After that it was left on magnetic stirrer for 19 hours until fully transparent and homogeneous solution was achieved.

Each solution was weighted after being stirred in order to know the amount of evaporated acetone, therefore missing volume of acetone was added to the solution and mechanically stirred for 5 minutes.

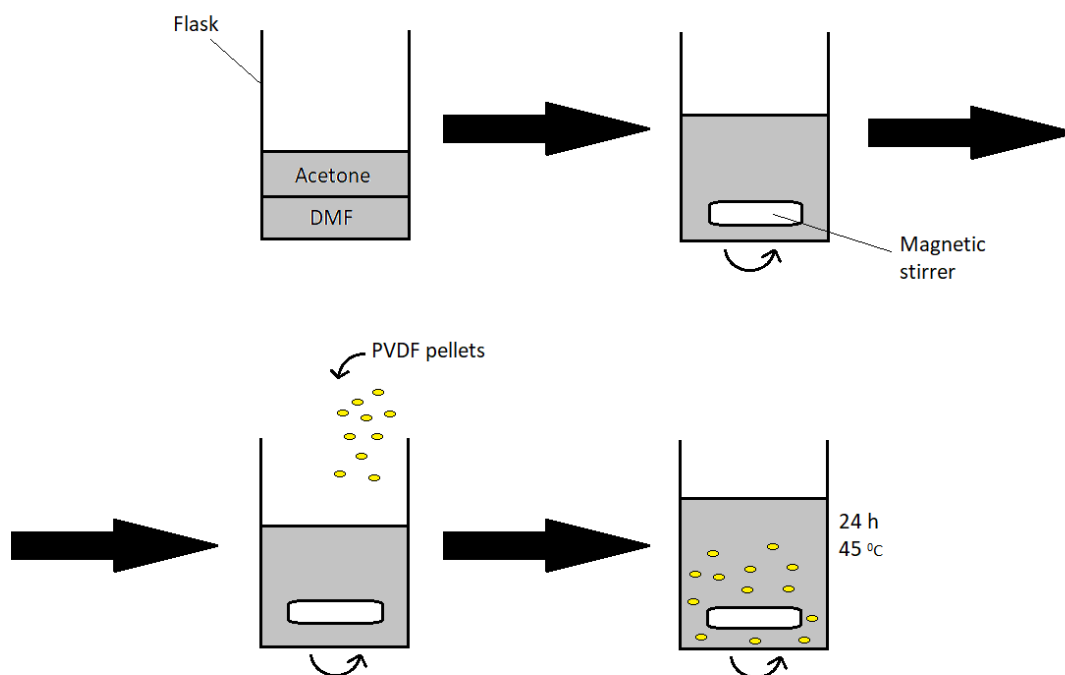

Figure 15 Solution preparation procedure.

Figure 15 presents the procedure of the solution preparation. The solvents were added before inserting the PVDF pellets. Solvents were mechanically stirred for 5 minutes before adding the polymer. The reason to add the PVDF granules after the solvents and magnetic stirrer was to prevent the pellets from sticking to flask's walls. That increased amount of time necessary to completely dissolve the polymer. As other components were already inserted, and the flask was set on the heater plate, PVDF granules were added into already mixing solution, thus they were already in motion on the moment of input. In 24 hours of stirring, the solution was very well transparent. Still, it occurred that keeping the constant temperature at 45 °C provides more adequate dissolvent of the polymer, thus it was decided to keep the temperature at the same level for 24 hours as well.

Prepared solution was separated into 2 different flasks with 5 g of solution in each, in order to test the electrospinning process. Influence of sonication and FS addition was also examined.

FS was added to the second flask in concentration of 3% of the mass of the PVDF and mechanically stirred for 24 hours. As the solution had to be tested both sonicated and not sonicated, it was decided to electrospin untreated solution first, then put the solution flask to the sonicator, and electrospun treated solution later again.

According to the investigated article [3], sonication and addition of fluorosurfactant both improve electrospinning process as well as the properties of the fibers. Thus it was decided to test 4 different solutions: untreated solution of 16% PVDF in 2:3 DMF/acetone; sonicated for 30 min solution of 16% PVDF in 2:3 DMF/acetone; untreated solution of 16% PVDF in 2:3 DMF/acetone with addition of FS with concentration 3% of PVDF; sonicated for 30 min solution of 16% PVDF in 2:3 DMF/acetone with addition of FS with concentration 3% of PVDF.

1 ml syringes were used with needle diameter of 0.8 mm. Needle to collector distance was 20 cm and the voltage was set to 15 kV. Pumping rate for the first solution was 1.4 ml/h, yet sonicated solutions as well as the ones with addition of FS were electrospun at feed rate of 1.2 ml/h.

Electrospinning process description:

First electrospinning was conducted for untreated solution. The process showed promising results as the fibers were easily collected on the drum. No solidification of the solution on the tip of the needle was noticed. The electrospinning under these conditions did not require to be monitored as the process was stable. At first, the electrospinning parameters were manipulated in order to see the effects of changing the voltage, feed rate and the needle tip to collector distance over the stability of the process. Increasing the distance over 20 cm resulted in insignificant amount of fibers to be collected on the drum. Shortening the distance, on the contrary, provided material with wet fibers. That happened due to inadequate amount of time for solvents to evaporate, therefore the residues of unevaporated solvents were deposited on the drum as well. Voltage that was lower than 15 kV did not provide enough powerful electrostatic field to overcome the surface tension of the polymer. Increased voltage initiated electrospinning process that cannot be used to obtain PVDF membrane with  $\beta$ -phase. Pumping rate manipulations lead to solution droplets formation by overcoming the 1.4 ml/h limit, in case of undergoing that limit, portions of the fibers were acquired by electrospinning, as the solution was not supported in volumes to provide constant ES. That results in fibers that are not aligned and uniform. Using 15 kV voltage with pumping rate at 1.4 ml/h and tip to collector distance of 20 cm was decided to implement in further electrospinning with sonicated solution and the ones with added FS.

After sonicating the solution in a water bath sonicator for 30 electrospinning showed similar results as the first one. Process was stable and could be left with minimal attention. Fibers accumulation on the collector was high as there were no fibers noticed on other sides of the

chamber or ventilation. Sonicating the solution before electrospinning does not affect the process, thus it is not required to be done. However the fibers morphology was later evaluated after SEM observations and proved to be of higher quality compared to untreated solution. Manipulation of the ES parameters were conducted the same way as for the first test. The results were similar, concluding that setting the needle to collector distance to 20 cm gives enough time for the solvent to evaporate before reaching the drum. Voltage of 15 kV is perfect value to prevent the electrospay as well as droplets formation. Pumping rate at 1.4 ml/h supports constant supply of solution for the Taylor cone to be apparent and further electrospinning in constant manner.

Addition of the FS to the treated solution has affected the electrospinning in unacceptable way. The process was hard to control as the solution solidified instantly exiting the needle, thus requiring to stop the electrospinning in order to clear the tip, then restart the ES. It was decided to reduce the pumping rate to 1.2 ml/h in order to minimize the formation of droplets on the tip of the needle. Even though the amount of beads was slightly less than with 1.4 ml/h feed rate, ES process was still not stable. As the solution solidified approximately every 2 minutes, constant control over the process was required. Solution was too viscous, therefore it was hard to electrospin. Addition of FS affects the ES in negative way, thus there is no reason to add it to the solution. The morphology of fibers with addition of FS was evaluated after SEM observations.

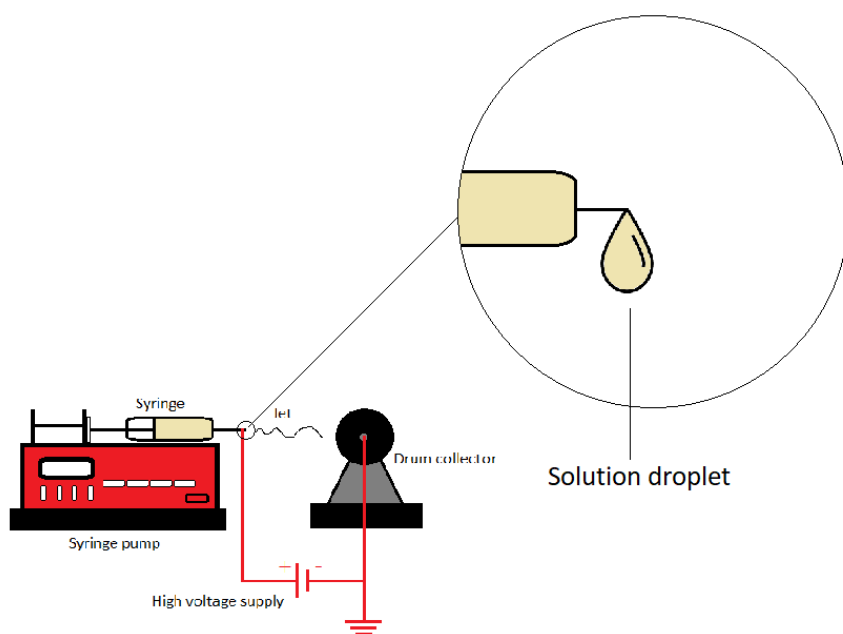

Figure 16 Solution droplet during the ES.

Figure 16 very well illustrates the formation of the solution droplet during the electrospinning process. While the tests with addition of FS were conducted, similar droplets were accumulated on the tip of the needle. Agglomeration of the solution followed by its fast solidification, thus preventing the supply of the remaining materials. Therefore it was necessary to stop the ES in order to carefully clean the needles off these formations. In total it took a lot of time to cleanse the needle, due to the fact that clogging appeared frequently. At the same time, stopping the ES did not indicate that it was safe to enter the chamber. Electrostatic field required few seconds to dismiss, so that additional waiting was required in order not to get electrical discharge.

Sonicating the solution with added FS for 30 minutes before electrospinning did not improve the ES process. Addition of FS still made the solution hard to spin. Fibers were barely collected on the drum, as the solution was solidifying instantly after exiting the needle, thus requiring to pause the ES every few minutes to clear the tip. Comparing the control over the ES process with sonicated solution, with and without addition of FS, it can be concluded that FS drastically worsens the electrospinning. The morphology of fiber was later evaluated after SEM observations. Concluding the neither sonication nor addition of FS are necessary for successful electrospinning.

Acquired membranes did not possess enough thickness for tensile tests. It was very difficult to separate the membranes from the collector material without damaging it. Insignificant thickness of the produced materials was also possible to observe as it was possible to see through the membrane, due to appearance of empty areas. Thus it was decided to prepare larger quantity of solution and electrospin it for longer time using the same parameters. That would result in simpler separation of the membrane and the collector material, as well as more reliable results of the tensile tests.

Syringes with capacity of 3 ml were used, yet other parameters remained the same. Manipulation of the electrospinning parameters was not required as the only difference was in quantity of the solution used during the process. Electrospinning process was conducted without any disturbances, whether a lot of fibers were collected on the pump and chamber walls, resulting in material not thick enough for proper tensile test. Thus it was decided to implement electrospinning for 3 hours using the same solution.

Following the previously used technique, 10 g of solution was prepared, that was later divided into 2 parts, in order to implement sonication for one of the solutions. It was also decided to

use probe type sonicator instead of water bath type as it has more power, thus more efficient sonication can be achieved. FS addition was no longer required as the ES process is much harder to control due to the presence of FS.

Therefore two different solutions were prepared: untreated solution of 16% PVDF in 2:3 DMF/acetone; sonicated for 30 min solution of 16% PVDF in 2:3 DMF/acetone. Electrospinning conditions were the same as described previously.

Electrospinning of untreated solution went without any disturbances as predicted by the previous experience. Proper parameters that were tested earlier provided stable process. Even though it was possible to keep the electrospinning for 3 hours without attention as no issues were observed before, it was decided to monitor the process in case of unexpected complications to appear. Solution did not solidify on the tip of the needle. Even though some of the fibers were attracted to the walls of the chamber, most amount of the electrospun solution was collected on the drum. Although the process went without any disturbances, the drum motor's belt got worn off that required it to be changed, so that it would not break during the further tests.

Using the Bandelin Sonoplus probe type sonicator for 30 min of pretreatment of the solution did not have effect on the process. Electrospinning was stable. Yet, time to time the polymer solution started to dry up too fast and the tip of the needle started to clog. It had to be cleaned approximately every 20 minutes. Fibers did not deposit only to the collector, but were also spreading in different directions. Continuation of the ES process increased the amount of the fibers collected on walls of the chamber. Properties of the produced membranes were later evaluated by SEM observations and tensile tests. The best results were shown by untreated solution with no addition of the FS.

## Double pump

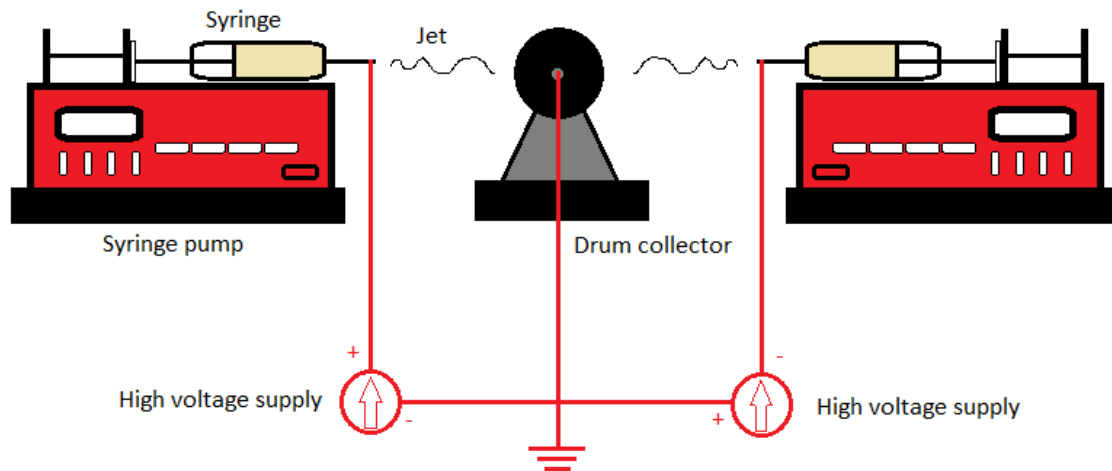

Figure 17 Double-pump setup schematic.

As the most suitable parameters to produce electrospun PVDF membranes were discovered, it was decided to use double pump electrospinning system (see Fig. 17) with differently charged solutions, in order to receive a better charge dispersion over the membrane.

The set up consisted of two pumps on each side of the chamber, earth-grounded collector drum in the middle and two power supplies. In order to electrospin larger quantities of solution, 3 ml syringes were used. Cables were connected to the syringes in order to have negatively charged one on one side, positively charged one on the other side. Such set up was meant to achieve good charge dispersion over the membrane. It was decided not to sonicate solution as it only affected the fibers morphology, not the electrospinning process.

Due to size limitations of the chamber the needle to collector distances was reduced to 10 cm. Voltage was set to 7.5 kV. Feed rate was set to 1.0 ml/h.

Electrospinning was hard to control, as the fibers were floating around inside the chamber. A lot of fibers were pulled to the ventilation. Tips of the needles had to be cleaned frequently as solution started to create droplets. That required to stop the process and restart it again, so that, the ES had to be constantly monitored. Due to differently charged solutions, the jets were attracted to each other, therefore started to bond during the flight before reaching the collector. Such behavior of the material could not result in evenly dispersed charge over the membrane. Voltage and feed rate were also changed in order to see if stable ES process could be achieved. Lowering the voltage from 7.5 kV resulted in weak electrostatic field that could

not overcome the surface tension of the polymer, that resulted in larger amount of droplets accumulation. Raising the voltage higher than 7.5 kV initiated the electro spray process that is not acceptable for this work. Increasing the pumping rate resulted in escalation of the solution droplets obtainment that could not be turned into Taylor cone and further electro spun properly. On the other hand, lowering the feed rate provided insufficient amount of solution to be affected by electrostatic field. In that case, solution was electro spun partially. Manipulations of the applied voltage and pumping rate proved that the most stable ES can be achieved at 7.5 kV and 1.0 ml/h. Double pump ES did not result in proper fibers distribution, thus using this method again was not required.

### **Yarn electrospinning**

For the reason that proper parameters to electro spin PVDF membranes were found, it was decided to implement used solution in the yarn electrospinning. Solution of 16% PVDF in 2:3 DMF/Acetone was prepared in mass of 15 g.

Syringe needles were inserted into the chamber on two opposing sides, as well as being connected to two different power supplies in order to have negative and positive charged solution jets. Polyamide 6 multifilament textured yarn was drawn through the electrospinning chamber as a core yarn where the nanofibers were wrapped on.

As the pumping rate was in value of ml/min the 5 ml syringes were used. Needle diameter was kept the same 0.8 mm, voltage was set at 7.5 kV and feed rate was 1.4 ml/min.

Successful electrospinning was not achieved. Fibers were not collected on the yarn, most of them deposited on the bottom of the chamber. During the ES spinnerets were elevated higher, in order to prevent fibers from falling. Yet, that displacement did not increase the rate of fibers collected on the yarn. Amount of acetone in the solution was too high, thus it did not dry out fast enough.

It was decided to change solution components ratio. DMF/Acetone ratio was changed to 3:2 in order to reduce the amount of acetone.

At first, new made solution was tested with conventional electrospinning in order to find out if producing fibers with new concentrations is possible.

Electrospinning at such parameters was hard to control. As the solution started to spin at much lower voltage of 5 kV the used pumping rate was also lower with value of 0.6 ml/h. It



was required to lower the pumping rate in order to prevent solution dropping. Still, fibers were not very well collected on the drum as a lot of them were accumulated on the pump, sides of the chamber and ventilation.

Nevertheless, the new solution was used for yarn ES. During the process voltage was set at 8.1 kV with pumping rate of 2.8 ml/min.

Changed conditions did not improve the outcome. Maximum power of the ventilators was not enough to prevent fibers from falling on the bottom part of the chamber. Still small portion of the material was collected on the yarn, yet not uniformly. A lot of solvent was also on the yarn.

It was decided to reduce the solvent amount and increase the polymer concentration. The new solution was prepared by previously used approach, yet with different component ratio. DMF to acetone ratio was decided to equalize to 1:1.

For the yarn ES was decided to test different voltage and pumping rate during the process. The initial voltage was 8.1 kV and pumping rate was set at 2.8 ml/min.

Yarn was partly covered with fibers. Voltage was raised to 10.1 kV in order for avoid solution dropping. But fibers were still not collected on the yarn in a way of continuous covering pattern. As the amount of solution was too high for the ventilators to keep in the air, it was decided to reduce pumping ratio to 0.8ml/min, therefore voltage was reduced to 6.0 kV. Nevertheless, electrospinning was not successful as fibers were still not collected on the yarn. Maintaining same voltage, increased pumping rate at 2.8 ml/min was tested with no relevant results.

After unsuccessful tests, the ventilation system was changed to more powerful one. Thus the used solution was the one that provided the most proper membrane electrospinning.

However, nanofibers were still not collected on the yarn. Due to such result, the used type of yarn was changed from textured on to flat yarn. Another reason to change the yarn type was to use more elastic one. During the ES the textured yarn was under tension and stretched, however after removing the yarn from the collector drum it will outstretch, the nanofibers will not be aligned anymore. For the starting point in new test, ES conditions and solution parameters remained same as in previous test.

Pumping rate and voltage were manipulated during the process in order to find stable conditions for further tests. Pumping rate was raised to 2.4 ml/min and 3.4 ml/min. Voltage at

the same time was raised till 12 kV that showed most stable result with 2.4 ml/min pumping rate. Raising it further to the 14 kV was too much, disturbing the stability of ES. The perfect pumping rate does depend on the voltage, thus it cannot be said what voltage is the best as it should be set accordingly to the used voltage. Further tests are required to understand which parameters are the best for stable yarn ES.

### 3 RESULTS AND DISCUSSIONS

#### Scanning electron microscopy

Each electrospun membrane was observed under SEM using HITACHI, TM-1000 tabletop microscope (Japan). On SEM images great attention was paid on the morphology of the yarns to conclude the effects on electrospinning after the change of the spinning parameters.

The prepared samples were cut off the electrospun membrane and placed onto the carbon tape. After the samples were inserted into observation chamber, SEM was vacuumed in order to remove any interference of extra elements.

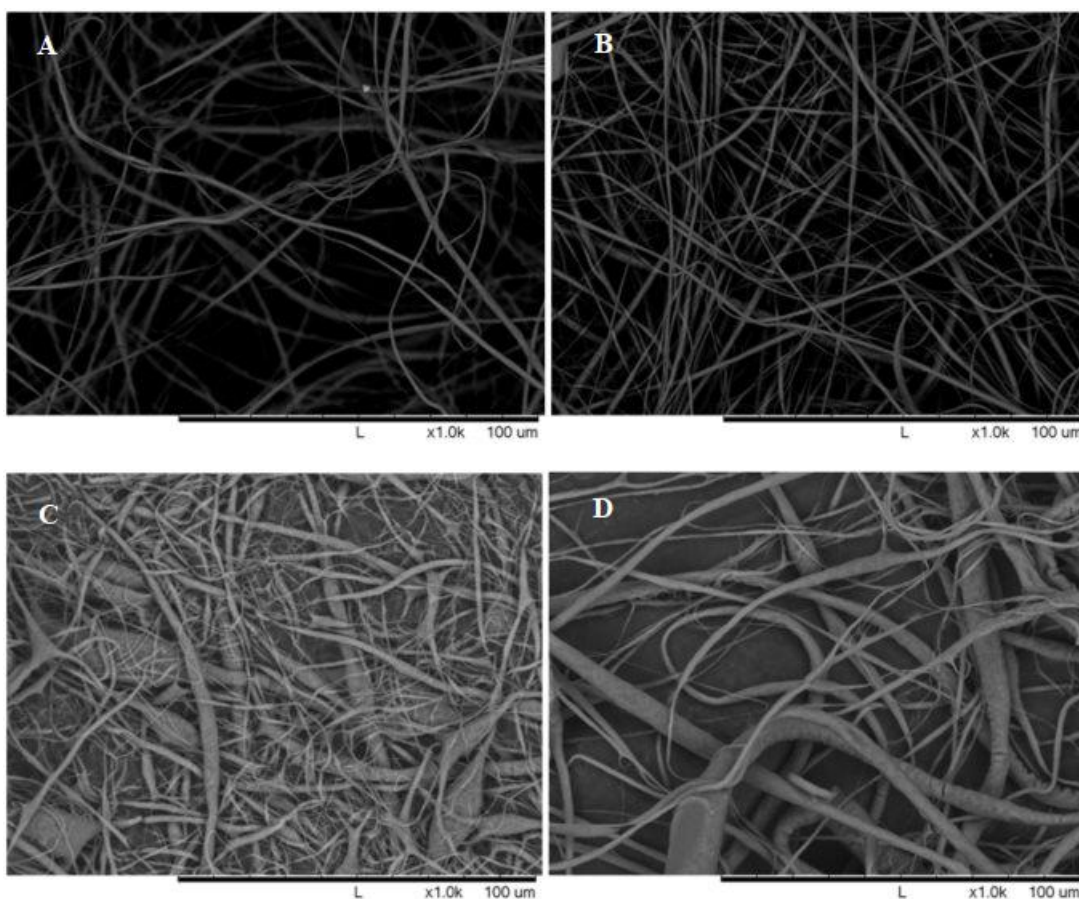

Figure 18 Electrospun PVDF solutions observed by SEM. Untreated solution of 16% PVDF in 2:3 DMF/acetone (A), sonicated for 30 min solution of 16% PVDF in 2:3 DMF/acetone (B), untreated solution of 16% PVDF in 2:3 DMF/acetone with addition of FS with concentration 3% of PVDF (C), sonicated for 30 min solution of 16% PVDF in 2:3 DMF/acetone with addition of FS with concentration 3% of PVDF (D).

Acquired figures show that addition of FS affects fibers morphology in a poor way (Figure 18. C, D). In samples, with FS present (C and D), fibers are not uniform. As it was not possible to

achieve stable electrospinning process (solution was spinning partially) therefore corresponding pattern of fiber accumulation can be seen. A lot of fibers short enough to fit on the SEM image. That means that achieving aligned uniform fibers is not possible with the addition of the FS. A lot of beads are appearing as well, that can be explained by insufficient evaporation of the solvent during the flight. Fibers diameter has huge variability (401.13 – 4675.71 nm). The reason to use FS was to decrease the surface tension of the solution, in order to increase the speed of the material production. Still, with reduced surface tension, higher amount of solution was flowing through the needle. That lead to accumulation of the beads on the material. It was necessary to find the most effective way to produce the PVDF nanofibers with piezoelectric properties, but in order to keep the productivity of the ES process and obtain fibers of better properties addition of FS was not needed. Therefore, no additional use of FS was required for further tests.

Sonication, however does improve the properties of fibers (Figure 18. A, B), making them more uniform, excluding beads formation and reducing fibers diameter's deviation.

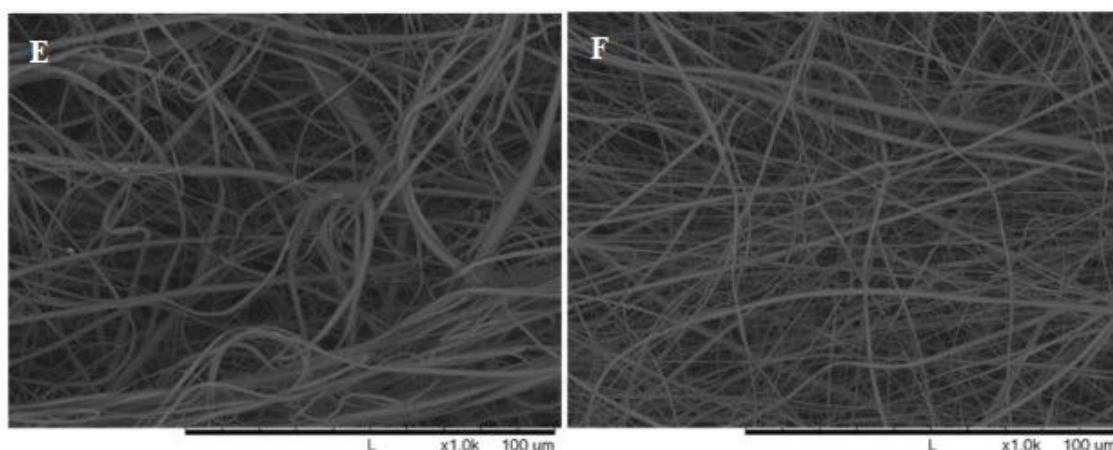

Figure 19 Electrospun PVDF solutions for 3 hours observed by SEM. Untreated solution of 16% PVDF in 2:3 DMF/acetone (E), sonicated for 30 min solution of 16% PVDF in 2:3 DMF/acetone (F).

On the solution containing 16% PVDF in 2:3 DMF/acetone (Fig 19. F), sonication was carried out in probe type sonicator rather than water bath type as it is more powerful and achieves better electric conductivity and decreased surface tension. Observed samples were electrospun for 3 hours. As it can be very well seen, the sonicated sample does show superior physical properties of the fibers. There are less beads, fibers are uniform and diameters varying from 233.77 nm to 1442.08 nm (see Table 1). These values are lower than the same parameters on untreated sample where diameters vary from 359.67 nm to 2382.59 nm. Thus, the sonication of the solution before electrospinning is necessary in order to have fibers with excellent properties. Using probe type sonicator is also necessary to achieve fibers with lower

diameters. Samples A and B (see Table 1) showed that membranes produced of sonicated solution had higher fiber's diameters than using the untreated solution. That can be explained by using bath type sonicator that is less powerful than probe type. Nevertheless, this project did not require optimization means for fiber morphology, as the main goal was to find suitable condition for the best membrane electrospinning conditions. In our case yarn electrospinning does not require strong fibers since the method uses strong core yarn. Therefore further sonication of the solution was excluded to save production time keeping in mind to implement this material as a candidate for industrial production in the future.

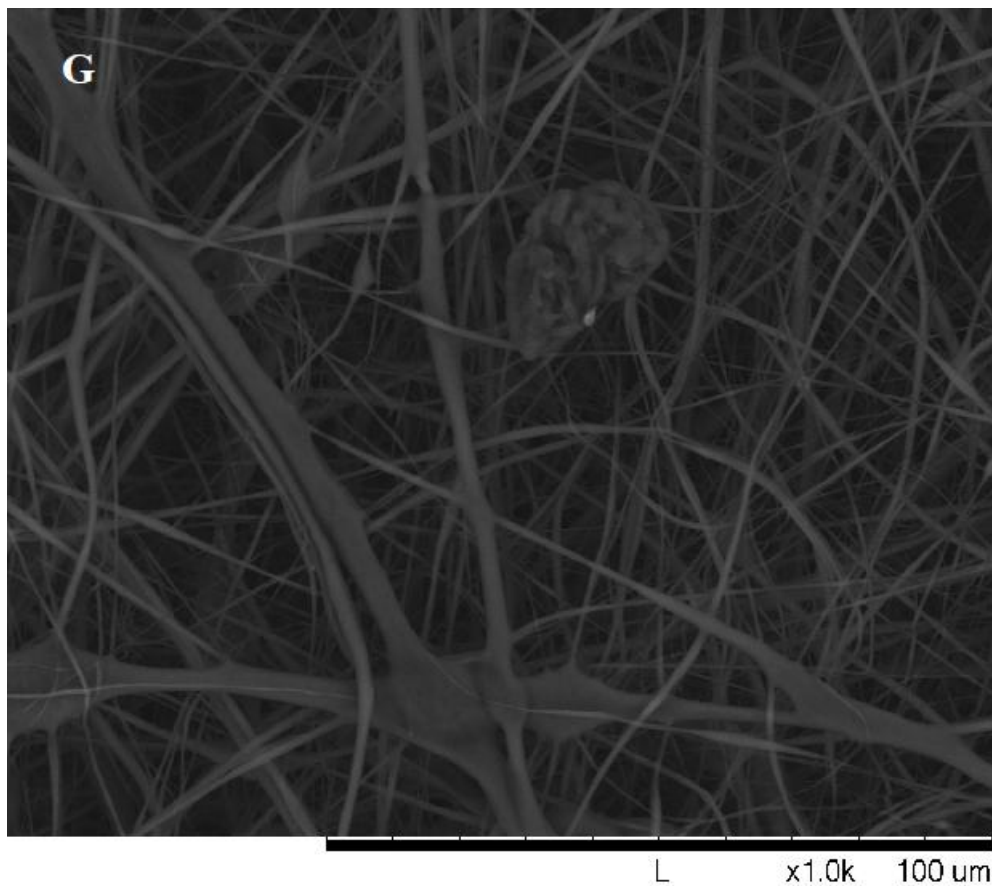

Figure 20 PVDF membrane produced by double pump ES.

Observed sample of membrane received by double-pump electrospinning (Fig. 20) shows unpromising results. Spreading of the fibers is uneven. That is due to the fact, that electrospinning stability was not achieved, therefore big amount of fibers were collected on different parts of the chamber rather than the collector. Huge diameter variety from 351.56 nm to 2543.57 nm can be observed. Large amount of beads as well as solution droplets are present indicating that the fibers were wet during the ES. There was not enough time for the solvent to evaporate during the flight. The fibers themselves were not uniform. That is also

explained by the instability of the ES process and inappropriate evaporation of the solvent. Perhaps, specifically designed chamber could have influence the results. As for this work, the working area was limited to the size of the chamber as the maximum distance between the needle and the collector was 10 cm. Increasing this parameter would give the solvent enough time to evaporate during the ES. Unfortunately, there was no such equipment to conduct double-pump electrospinning test with possibility to manipulate this parameter. This proves that double-pump technique would require further tests to investigate the best needle to pump distance, pumping rate and voltage parameters.

Table 1. Fiber diameter comparison of the observed samples.

Sample	Avg. fiber diameter, nm	Min. fiber diameter, nm	Max. fiber diameter, nm
A	824.23	262.04	1908.07
B	890.8	420.17	1850.49
C	1218.53	401.13	4707.03
D	1489.98	444.8	4675.71
E	913.49	359.67	2382.59
F	617.93	233.77	1442.08
G	759.9	351.56	2543.57

Table 1 provides informative overview over the influence of differently used techniques for preparation of the PVDF membranes. Samples A and B can be compared to sample E and F, as the main difference in them is the amount of time spent on production. Electrospinning for sample A and B was implemented using 1 ml of the solution for each, whether for preparing sample E and F 3 ml of the solution was used for each. As it can be seen on the Table 1, average fiber diameter is different for sonicated sample (B and F) in comparison to untreated ones (A and E). The electrospinning that was conducted for smaller amount of time, provided information that sonicated solution results in obtaining fibers with bigger diameters. At the same time the electrospinning that was carried out for three time longer period shows the significant reduction of fiber's diameters for the sonicated solution. From this data it can be concluded that sonication does reduce the average fiber diameter, because sample F has more valuable data regarding the average value calculations in comparison to sample B, as the amount of acquired fibers from 3 ml solutions is enormously higher than the one of 1 ml solution. Another fact that influenced the fiber diameters is the type of the sonicator that was used. At first water bath type was used, which was later changed to probe type sonicator that provided more sufficient sonication of the solution resulting in fibers of higher quality.

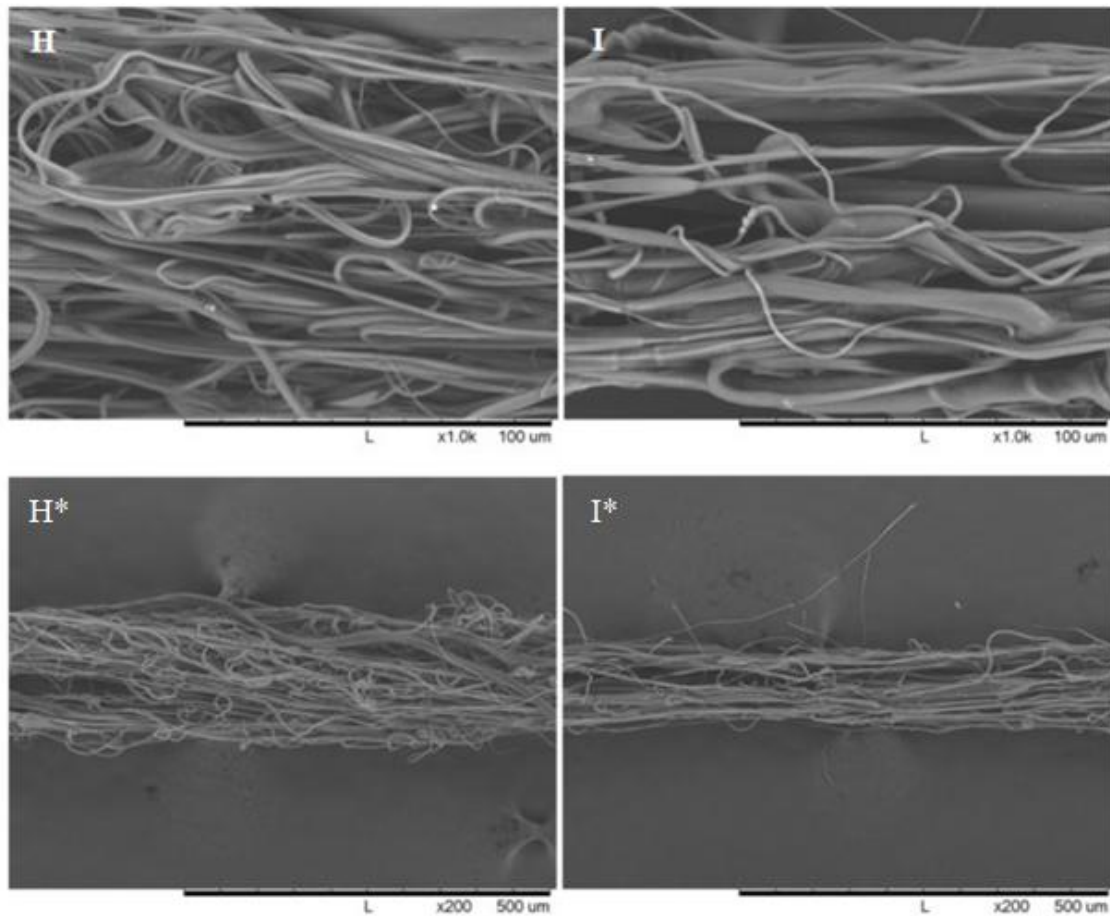

Figure 21 Yarn ES with different yarn types. Textured yarn (H), flat yarn (I).

Figure 21 provides information about the results of yarn electrospinning using textured (Fig 21. H) and flat (Fig 21. I) core yarn types in order to understand their difference. Figure 21 H\* and I\* represent different yarns at lower magnification of x200. Both core yarns are partly covered with fibers, yet the textured yarns are stuck to each other and it is not possible to separate them. The reason behind the yarns being merged is that the fibers were wet during the electrospinning. That indicates that the flight time is too short for solvents to evaporate of the jets. However, the flat type yarn showed greater performance during the ES, as the amount of collected fibers was higher and their spreading across the yarn was of higher quality than on textured yarn.

## FTIR

In order to understand chemical properties of the fibers, FTIR tests were implemented using Interspec 200-X. During the electrospinning  $\beta$ -phase should appear on the membrane that signals the piezoelectric property of the material.  $\beta$ -phase appears during the stretching of the

material that occurs when the solution is electrospun. To see if such transition appeared, electrospun fibers were tested on the FTIR spectrometer.

To insert the samples into the sample holder, acquired solution was laid on the glass slide, then dried for 24 hours at room temperature in order to receive a thin film. Testing the PVDF pure pellet was rather challenging as the pellet's shape did not allow proper FT-IR test, thus it was dissolved, then put onto the glass slide and dried till the solvent was fully evaporated providing a thin film. In order to compare the appearance of  $\beta$ -phase, electrospun material was used. Each sample was cut into small piece and then folded few times so there could not be free spaces when the sample is inserted into the FTIR machine. Acquired results showed the difference in crystal structure of prepared membranes, whether they were untreated, sonicated or with addition of FS.

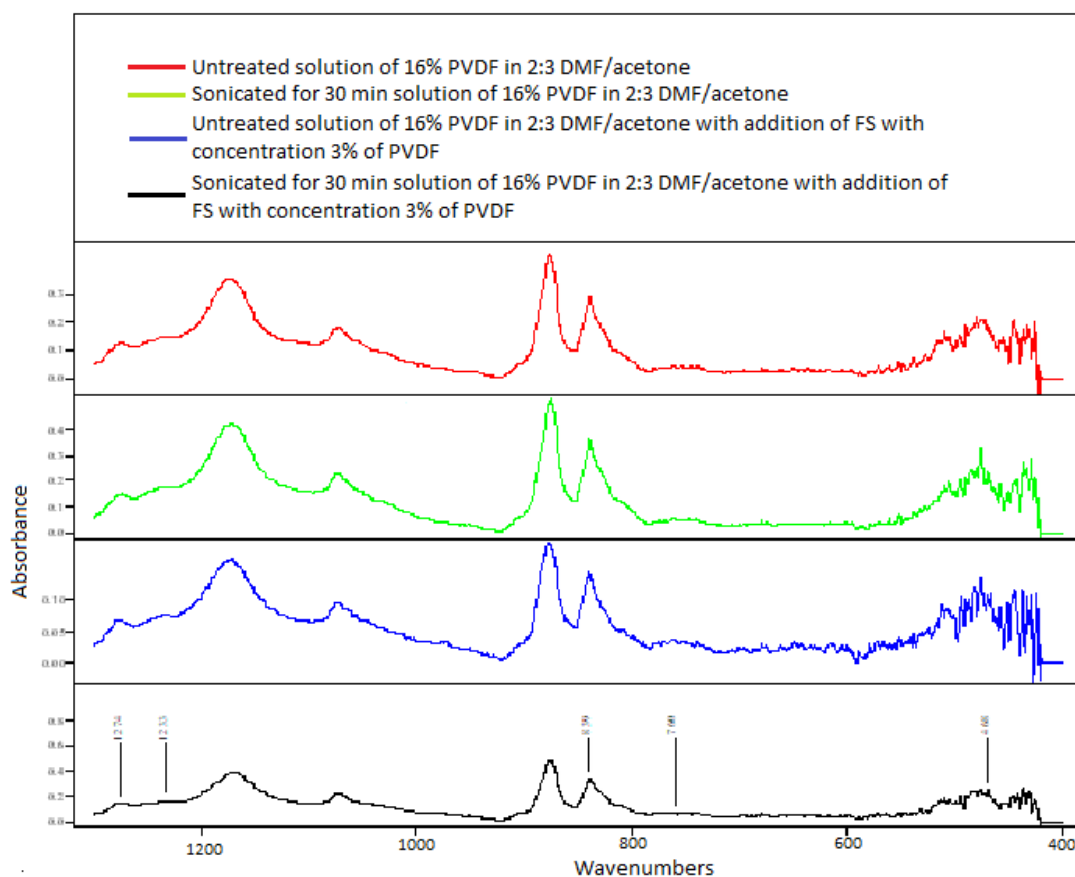

Figure 22 FTIR spectra of prepared samples.

During the data processing graphs were hardly understandable. In order to remove noise from the charts smoothing was used, thus creating clear line on the graph. Data below 400



wavenumbers had to be erased as the amount of noise was beyond converting into valuable data. Still,  $\beta$ -phase peak at wavelength 468 is hard to precisely observe.

Presented data (see Fig. 22) shows that all four samples are similar in terms of observed peaks. Addition of FS does not affect the chemical properties of the PVDF membrane. Untreated sample is identical to the sample that had the addition of FS. Yet, due to the fact, that fluorosurfactant diminishes the electrospinning process's efficiency by providing fibers with poorer characteristics and affecting the process's stability, without any influence over the intensity of  $\beta$ -phase, it was decided not to add the FS in further tests.

Figure 22 also proves that sonicating the solution before electrospinning did not influence the appearance of  $\beta$ -phase as its intensity is similar to other tested materials. In terms of increasing piezoelectric properties of the material, the sonication is not required. Nevertheless, physical properties of the material were significantly increased by sonication. Therefore implementing of the sonication depends on the desired properties of the material, whether it is only achieving  $\beta$ -phase on the material which does not require pretreatment, or also having superior mechanical properties that are provided by ultrasound sonication.

Peaks at 468, 1273 and 839 wavelength represent  $\beta$ -phase, that were acquired after ES. Peak at wavelength of 760 represents  $\alpha$ -phase, and at 1233 it can be seen that  $\alpha$ -phase is gone. Peak at 1273 wavelength is the most valid proof of the material's possession of the piezoelectric property as the  $\beta$ -phase is the most intense at that wavenumber.

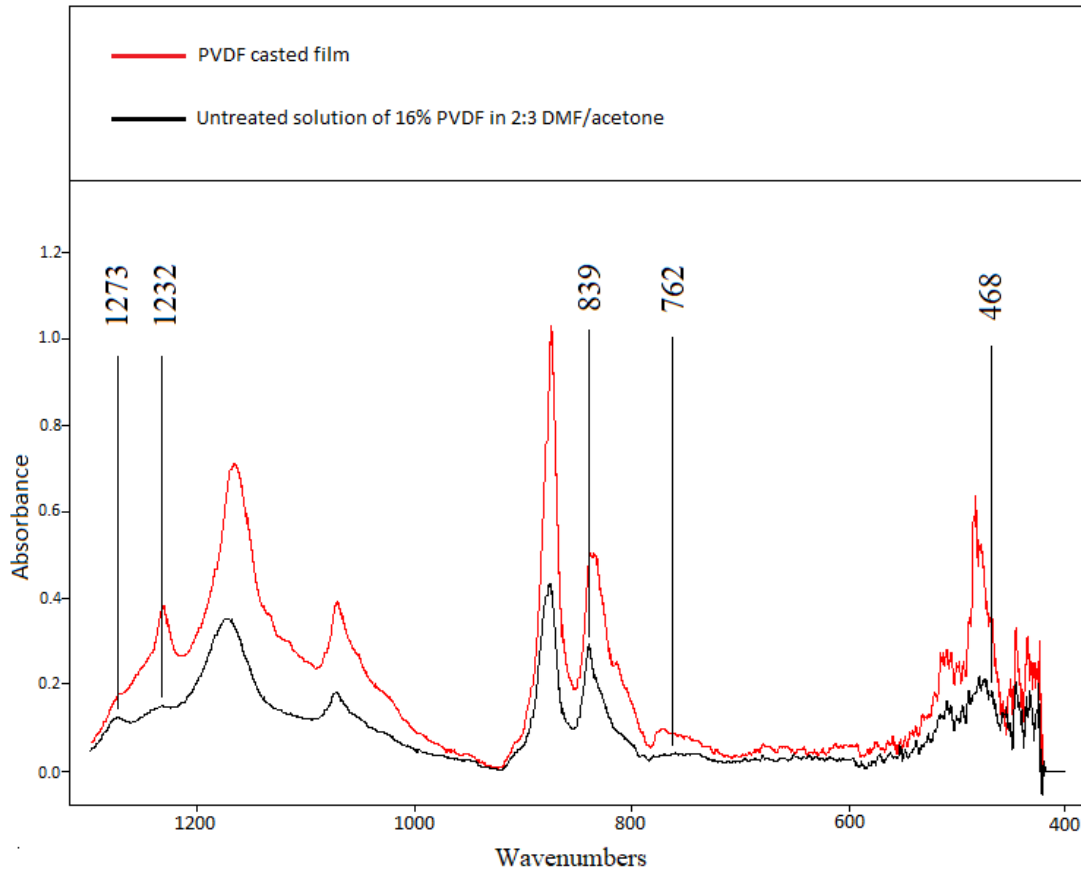

Figure 23 Comparison of pure PVDF and electrospun PVDF.

PVDF casted film was compared to the electrospun membrane. As the sonication and addition of FS have no influence over the chemical composition of the achieved material, it was decided to take untreated solution for the ES and therefore use it for comparison. The presented image (see Fig. 23) very well illustrates the difference between electrospun material and unaffected PVDF granule (in form of casted film). Peaks at 1232 and 762 present that the  $\alpha$ -phase is disappearing after electrospinning. As well as the  $\beta$ -phase is appearing at wavelength of 1273. During FTIR tests it was proved that achieving the  $\beta$ -phase in the PVDF material by electrospinning is possible.

### Tensile tests

In order to implement tensile tests Instron 5866 machine was used. There are various standards for different types of samples. Each of them has to be adequately prepared and proper grips have to be used during the test. For this specific work, prepared membranes were cut in width of 1 mm. Distance between the grips was 10 mm. Length of the test specimen is not sufficient, as the testing machine will straighten the specimen placed, then the actual

measurement of load withstanding will begin. Still, samples have to be prepared carefully, in order to avoid any differences in their sizes. As the electrospinning method cannot guarantee constant thickness of the sample at every point of it, those values have to also be measured and used for comparison of different membranes, as they might have different thickness. Before the test, membranes were measured in order to find an area that would provide 10 samples of the required shape.

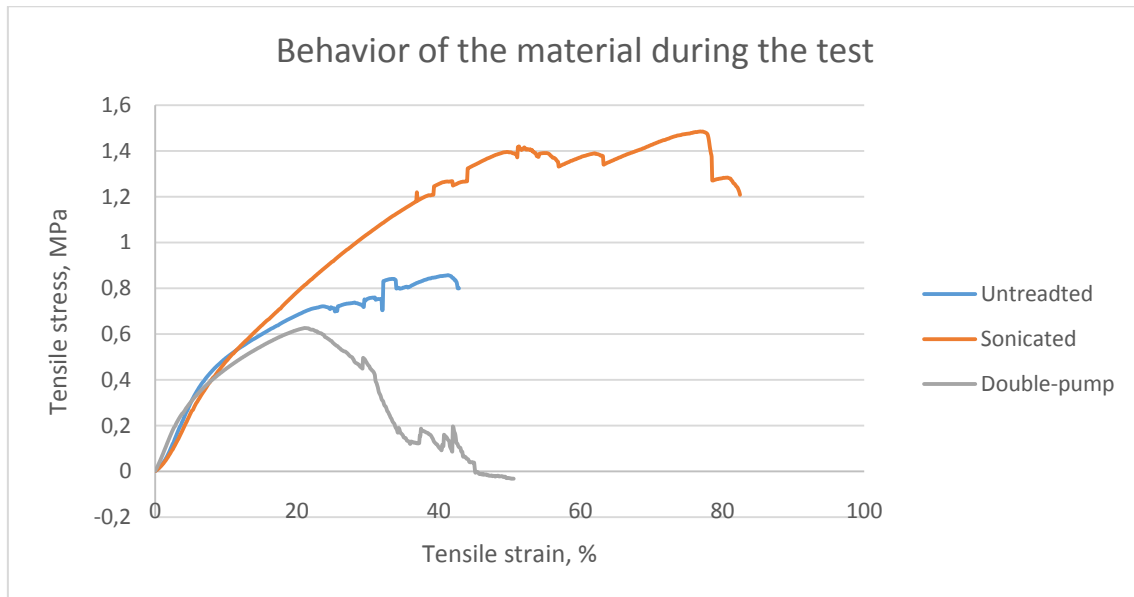

Figure 24 Behavior of the material during the test

In order to compare the material's response to applied tensile stress and elongation, three sets of differently manipulated solutions were electrospun into membranes. Each set contained 10 individual test samples (see Fig. 24) Received results represent how differently prepared PVDF membranes react to tensile stress and elongation. Obtained curves show the average values of the tested samples. It can be very well seen, that sonicated solution produces the fibers of better tensile properties, than untreated samples and the ones prepared by the double-pump technique. Compared to untreated and sonicated samples, double-pump produced membranes could not withstand the tensile stress.

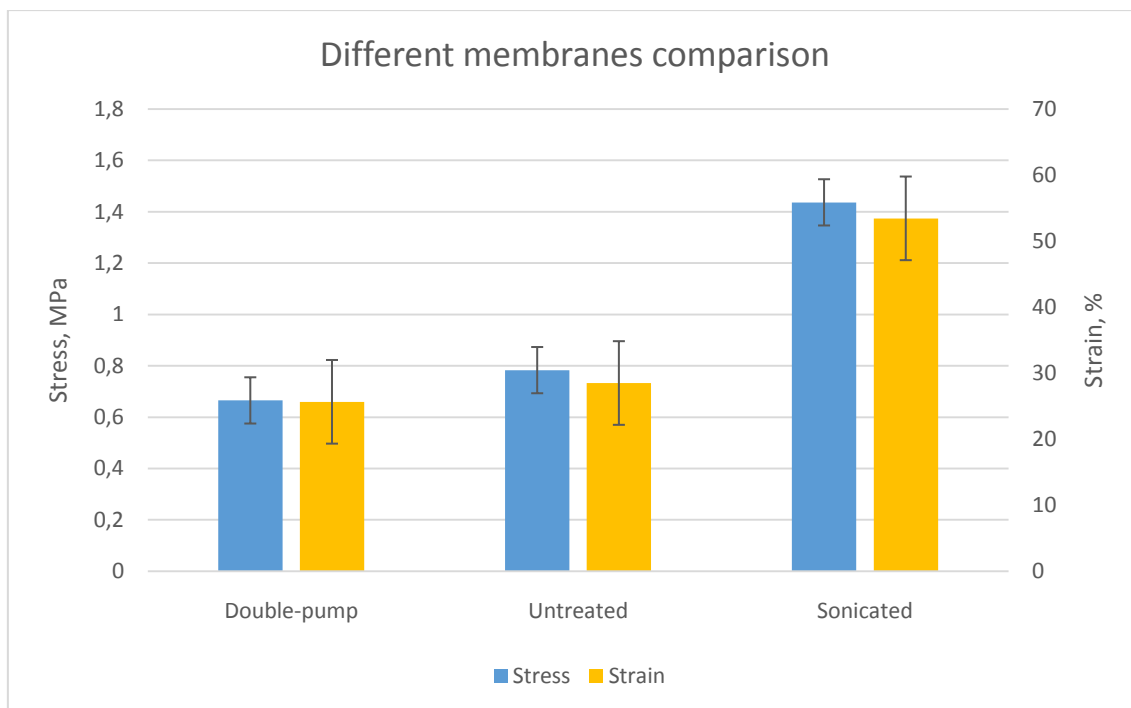

Figure 25 Comparison of tensile tests results

Acquired data represents the averages of maximum stress and strain materials withstood before the breakage (see Fig.25). Membrane that was produced by conventional electrospinning technique with the untreated solution showed superior properties compared to the one produced by the double-pump. Observed results by the SEM of the membranes electrospun from untreated solutions (see Fig. 18 (A); 19 (E)) showed slightly better fiber dispersion than the membrane produced by double-pump technology (see Fig. 20). Figure 20 presents huge amount of beads over the membrane that was produced by double-pump technique. Fiber uniformity was not achieved as well. Therefore tensile properties of the material were inferior to those of conventionally prepared membrane. Despite the difference in electrospinning of the membranes of untreated PVDF solutions (see Fig. 18 (A); 19 (E)), there were no beads observed as well as fibers themselves were uniform, that lead to better tensile properties of these membranes. Even though the difference in highest achieved tensile stress and strain is not huge, Double-pump technique did not prove itself worthy the time consumed. On the other hand, electrospun sonicated solution had enormously positive results as the achieved values were twice as high as for the untreated samples. Comparing the images acquired by SEM (see Fig 18 (B); 19 (F)), it can be concluded that sonication of the solution before the ES improves the membrane's tensile properties by lowering the fiber's diameter variation and the average fiber diameter for sonicated materials are lower, that provided higher resistance to tensile stress and elongation. As the fiber's diameters are reduced, the alignment of the fibers escalates, resulting in better tensile properties.

Sample produced by double-pump technique showed the weakest tensile stress resistance. Highest achieved stress before breaking point was at 0.67 MPa with the sample being elongated for 25%. Sonicated samples, on the contrary, proved to have leading tensile properties. All specimens withstood 1.2 MPa stress while being elongated for 40%. Whether the highest withstood stress was at 1.43 MPa being elongated for 53%. Untreated PVDF membrane showed mediocre outcome. At 0.75 MPa the breaking point was reached with sample being elongated for 28%.

Regarding the physical properties sonication is necessary to achieve PVDF membranes with higher elasticity. Double-pump method did not provide material with high enough quality to further use this technique.

## 4 CONCLUSIONS

As the aim of the study was to find best characteristics for electrospinning of PVDF membranes, different polymer solutions were prepared. Suitable combination of components was 16% of PVDF in DMF/acetone with ratio of 2:3. The concentrations of solvents had to be well balanced in order to overcome DMF's high surface tension adding the acetone. It was found that amount of acetone could not be higher, so that the solvent could be vaporized off the electrospinning jet during the flight. PVDF concentration is 16% could also not be increased, due to the growth of the viscosity. Complete dissolvent was achieved in 24 hours of the solution stirring at temperature of 45 C°.

The most efficient way to combine the PVDF pellets with solvents is to fill the flask with liquids first, insert the magnetic stirrer, and lastly pour in the PVDF granules while the solution is already being stirred. That is done in order to prevent the polymer from sticking to the flask walls that troubles proper dissolving in given time.

Regarding electrospinning set up, the needle diameter was found to be optimal at 0.8 mm. Excellent applied voltage was 15 kV. Lowering that value lead to solution droplets as the electric field was not powerful enough to overcome the surface tension of the fluid. In case voltage was raised higher, constant ES was lost, and electrospray was appearing instead. The most suitable needle to collector distance settled to be 20 cm. Reducing that gap resulted in insufficient time for solvent to evaporate during the jet flight. Increasing the space between the collector and the needle leads to escalation of fiber diameters due to reduced electrostatic field strength, which leads to less stretching of the fibers.

Piezoelectric properties were proven to be achieved by FTIR spectra. According to Figure 23. required  $\beta$ -phase appeared after electrospinning the solution. Peaks at 1232 and 762 present that the  $\alpha$ -phase is disappearing after electrospinning. As well as the  $\beta$ -phase is appearing at wavelength of 1273. Therefore piezoelectric properties are yet to be measured in the future.

Following the SEM observations (Figure 18. B, D; Figure 19. F) sonicating the solution for 30 minutes before electrospinning does influence the fibers morphology. Both, water bath and probe type sonicators show superior results compared to untreated samples. Fibers obtained are more uniform. Beads formation as well as fiber diameters deviation are reduced. Sonicating the solution is necessary to achieve the membranes with greater properties. Piezoelectric properties of the material were not affected by the sonication as can be seen on

the Figure 22. However, sonication does not affect the ES process, therefore implication of this pretreatment is not effective in terms of time consumption. Tensile properties of tested samples showed superior results to untreated and double-pump prepared membranes. Sonication increases material withstand to stress and strain almost twice.

FS addition proved to be unnecessary as the both control over ES process and fibers, properties were extremely impaired. The needles started to clog, thus requiring the operation to be stopped and spinnerets to be cleaned. Such disturbance resulted in low amount of fibers gathered on the collector. FTIR spectra showed no influence by FS on piezoelectric properties of the materials. Observed materials (Figure 18. C, D) showed inferior results as to the samples where FS was not used. Given figures show the huge accumulation of beads and fiber diameters variety. Uniformity of the fibers was also not achieved. Said outcome determined that addition of FS was no longer required.

Electrospinning with two pumps and two differently charged solutions was expected to provide equivalent charge dispersion over the membrane. Unfortunately the ES was not successful as a lot of fibers were not collected on the drum. Resulted material has also shown poor morphology by SEM and inferior tensile properties compared to conventional ES technique.

According to previous PVDF membranes test results, untreated PVDF solution in different concentration variations were implemented in yarn spinning. Result was promising as it was possible to wrap core yarn with electrospun PVDF nanofibers under certain conditions. Numerous amount of tests is required to find out the perfect parameters for the core yarn to be adequately covered. During the investigation time, it was found that flat yarn type as a core yarn is preferable to textured type.

## SUMMARY

Aim of the work was to find most suitable parameters for PVDF nanofiber membrane preparation for implementing this technique in nanofiber yarn spinning. PVDF is known for its piezoelectric properties, thus managing to create and elongated fiber has a perspective in smart clothing production.

In order for PVDF to produce charge in response to physical deformation, the  $\beta$ -phase has to be achieved. As the elongation of the material under the presence of an electrostatic field provides the appearance of  $\beta$ -phase, electrospinning was used to create the membrane. Sonication of the solution and addition of fluorosurfactant were tested as well to see if they affect the fiber's properties.

Best results were achieved using 16% PVDF in 2:3 DMF/acetone solution. Electrospinning parameters were:

Voltage – 15 kV

Tip to needle distance – 20 cm

Feed rate – 1.4 ml/h

Needle diameter – 0.8 mm

Tensile tests showed that sonication does improve fiber's properties. Same result could be seen on the SEM images, as the fiber diameter variation is reduced after implying the sonication on the solution. Addition of FS affected both; ES process, making it hardly controllable, and the fiber's morphology, as a lot of beads were acquired and diameter's variation was huge. In order to produce membrane of finer physical properties sonication of the solution is required; nevertheless in terms of efficient time use to make piezoelectric PVDF material sonication is not needed.

Using the obtained data, solution of the same parameters was used in yarn electrospinning to produce PVDF covered yarn. Unfortunately, these tests did not have successful results, but it was proved that covering the core yarn with PVDF electrospun fibers is possible. Still this area requires further tests.



## REFERENCES

1. Properties and applications for Polyvinylidene fluoride. 25 03 2012. [Online]. Available: <http://www.base-chemicals.net/News/Properties-and-applications-of-Polyvinylidene-fluoride/> [Accessed 15 02 2018].
2. K. S. Ramadan, D. Sameoto, S. Evoy; A review of piezoelectric polymers as functional materials for electromechanical transducers. *Smart Material and Structure*, Volume 23, Number 3, 17 January 2014.
3. E. Tarasova, K.-G. Tamberg, M. Viirsalu, N. Savest, V. Gudkova, I. Krasnou, T. Märtson, A. Krumme, Formation of uniform PVDF fibers under ultrasound exposure in presence of anionic surfactant, *Journal of Electrostatics*, 2015, Volume 76, pp. 39-47.
4. W. J. Morton, ,inventor; W. J. Morton, ,assignee. Method of Dispersing Fluids. United States patent US 705,691. 1902 Jul 29.
5. W. J. Cooley, , inventor; C. S. Farquhar, A. Eastman, assignees. Apparatus for Electrically Dispersing Fluids. Unites States patent US 692,631. 1902 Feb 4.
6. A. Formhals, inventor; R.S. Gastell, assignee. Method and Apparatus for the Production of Artificial Fibers. United States patent US 2,158,416. 1939 May 16.
7. N. Tucker, J. J. Stanger, M. P. Staiger, H. Razzaq, K. Hofman, The History of the Science and Technology of Electrospinning from 1600 to 1995, *J Eng Fiber Fabr.* 2012, Volume 7, pp. 63–73.
8. Electrospinning technology for nanofiber production. [Online]. Available: <https://www.4spin.info/technology> [Accessed 15 02 2018].
9. K. S. Athira, P. Sanpui, K. Chatterjee; A schematic diagram showing the process of electrospinning Fabrication of Poly(Caprolactone) Nanofibers by Electrospinning *Journal of Polymer and Biopolymer Physics Chemistry.* 2014, 2(4), pp. 62-66
10. L. Wang, A. J. Ryan; *Electrospinning for Tissue Regeneration.* A volume in Woodhead Publishing Series in Biomaterials. 2011, pp. 3-33.
11. L. Xu. W. Han, G. Zheng, D. Wu, X. Wang, D. Sun; Initial Jet Before the Onset of Effective Electrospinning of Polymeric Nanofibers. *The Open Mechanical Engineering Journal* 2015; 9:666
12. C. Mit-uppatham, M. Nithitanakul, P. Pupaphol; Ultrafine Electrospun Polyamide-6 Fibers: Effect of Solution Conditions on Morphology and Average Fiber Diameter. *Macromol. Chem Phys.* 2004, 205, pp.2327-2338
13. C. M. Wu, H. G. Chiou, S. L. Lin, J. M. Lin; Effects of Electrostatic Polarity and the Types of Electrical Charging on Electrospinning Behaviour. *J Appl Polym Sci* 2012; 126: E89 – E97

14. Fiber Diameter control by parameters optimization, Voltage. 22.12.2015. [Online]. Available: <http://electrospintech.com/diameterparameters.html#.Ww-knoq-mUk> [Accessed 15 02 2018].
15. T. Mazoochi, M. Hamadani, M. Ahmadi, V. Jabbari; Investigation of the morphological characteristics of nanofibrous membrane as electrospun in the different processing parameters. *International Journal of Industrial Chemistry* 2012; 3: 2
16. R. M. Nezarati, M. B. Eifert, E. Cosgriff-Hernandez; Effects of Humidity and Solution Viscosity on Electrospun Fiber Morphology. *Tissue Eng Part C Methods*. 2013; 19: 810.
17. C. J. Thompson, G. G. Chase, A. L. Yarin, D. H. Reneker; Effects of parameters on nanofiber diameter determined from electrospinning model. *Polymer* 2007; 48: 6913.
18. V. Beachley, X. Wen; Effect of electrospinning parameters on the nanofiber diameter and length. *Materials Science and Engineering C* 2009; 29: 663.
19. F. Mokhtari, M. Latifi, M. Shamsheer; Electrospinning/electrospray of polyvinylidene fluoride (PVDF): piezoelectric nanofibers. *The Journal of The Textile Institute*, Volume 107, Issue 8, 2016.
20. X. Wang, K. Zhang, M. Zhu, H. Yu, Z. Zhou, Y. Chen, B. S. Hsiao; Continuous polymer nanofiber yarns prepared by self-bundling electrospinning method. 2008 *Polymer* 49 pp. 2755.
21. M. Viirsalu, T. Kivirand, A. Krumme, inventors; Tallinn University Of Technology, assignee. Device and method for preparing continuous nanofibrous yarns and bundles from electrospun fibers and fibrils. World patent Appl. No.: WO2016038539A1; 2016 Mar 17.
22. How Does Sonication Work? [Online]. <https://sciencing.com/sonication-work-5171302.html> [Accessed 19 02 2018].
23. Probe-type sonication vs ultrasonic bath: an efficiency comparison [Online]. <https://www.hielscher.com/probe-type-sonication-vs-ultrasonic-bath-an-efficiency-comparison.htm> [Accessed 19 02 2018].
24. M. Akram, A. Chowdhury, S. Chakrabarty; Removal of Rhodamine B Dye from Wastewater by Ultrasound Assisted Fenton Process: A Comparison between Bath and Probe Type Sonicators. *Environ Sci IND J*, Volume 12 (10), 25 October 2016.
25. Scanning Electron Microscopy [Online]. <https://www.nanoscience.com/technology/sem-technology/> [Accessed 19 02 2018].
26. Principles of SEM operation 21.06.2011 [Online] <http://www.amrf.org.au/myscope/sem/practice/principles/> [Accessed 19 02 2018].
27. A. Bliiah; Investigation of multiferroic and photocatalytic properties of Li doped BiFeO<sub>3</sub> nanoparticles prepared by ultrasonication. Bangladesh university of Engineering and Technology, Thesis, October 2014

28. How an FTIR Spectrometer operates 17.02.2015 [Online]. [https://chem.libretexts.org/Core/Physical\\_and\\_Theoretical\\_Chemistry/Spectroscopy/Vibrational\\_Spectroscopy/Infrared\\_Spectroscopy/How\\_an\\_FTIR\\_Spectrometer\\_Operates](https://chem.libretexts.org/Core/Physical_and_Theoretical_Chemistry/Spectroscopy/Vibrational_Spectroscopy/Infrared_Spectroscopy/How_an_FTIR_Spectrometer_Operates) [Accessed 19 02 2018]
29. B. Stuart; Infrared Spectroscopy: Fundamentals and Applications 2004 John Wiley & Sons, Ltd ISBNs: 0-470-85427-8 (HB); 0-470-85428-6 (PB) pp. 15-44
30. D. Kumar, B. Singh, K. Bauddh, J. Korstad; Bio-oil and biodiesel as biofuels derived from microalgal oil and their characterization by using instrumental techniques Algae and Environmental Sustainability, Developments in Applied Phycology Chapter: 7, Springer 2015
31. Tensile testing [Online]. <http://www.instron.co.uk/en-gb/our-company/library/glossary/t/tensile-testing?region=United%20Kingdom&lang=en-GB> [Accessed 19 02 2018]
32. J. Li, C. Tang, D. Wang, B. Shi; Effect of discrete fiber reinforcement on soil tensile strength. Journal of Rock mechanics and geotechnical engineering 6(2) April 2014
33. Tensile testing [Online]. <https://www.labtesting.com/services/materials-testing/mechanical-testing/tensile-testing/> [Accessed 19 02 2018]

## APPENDIX

Sample 1: 16% PVDF in DMF/Acetone solution in ratio of 2:3.

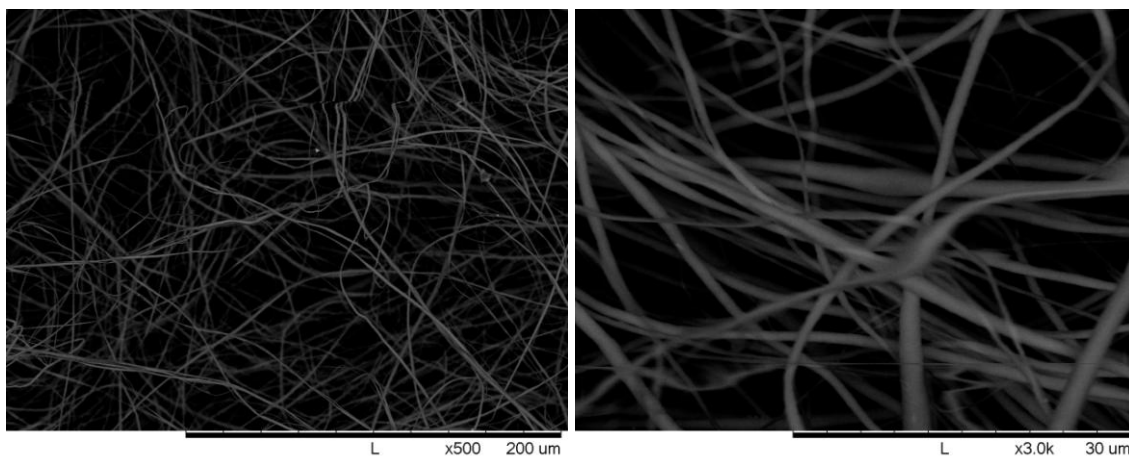

Sample 2: Sonicated 16% PVDF in DMF/Acetone solution in ratio of 2:3.

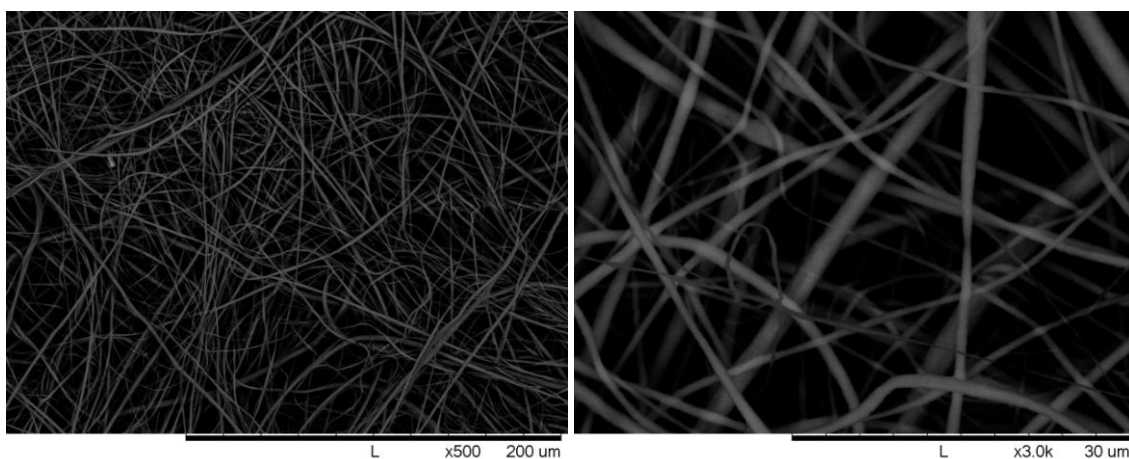

Sample 3: 16% PVDF in DMF/Acetone solution in ratio of 2:3 + FS in conc. of 3% of PVDF mass.

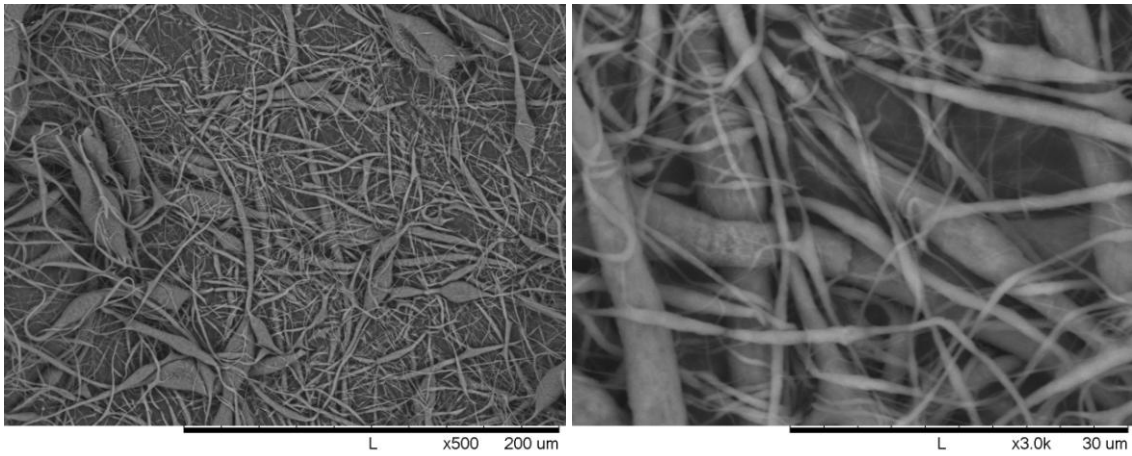

Sample 4: Sonicated 16% PVDF in DMF/Acetone solution in ratio of 2:3 + FS in conc. of 3% of PVDF mass.

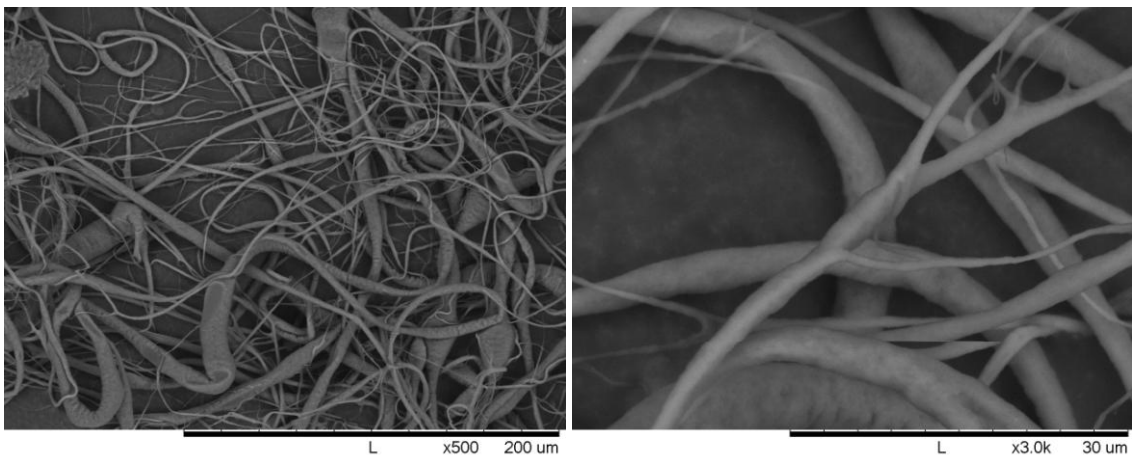

Sample 5: 16% PVDF in DMF/Acetone solution in ratio of 2:3. Electrospun for 3 hours.

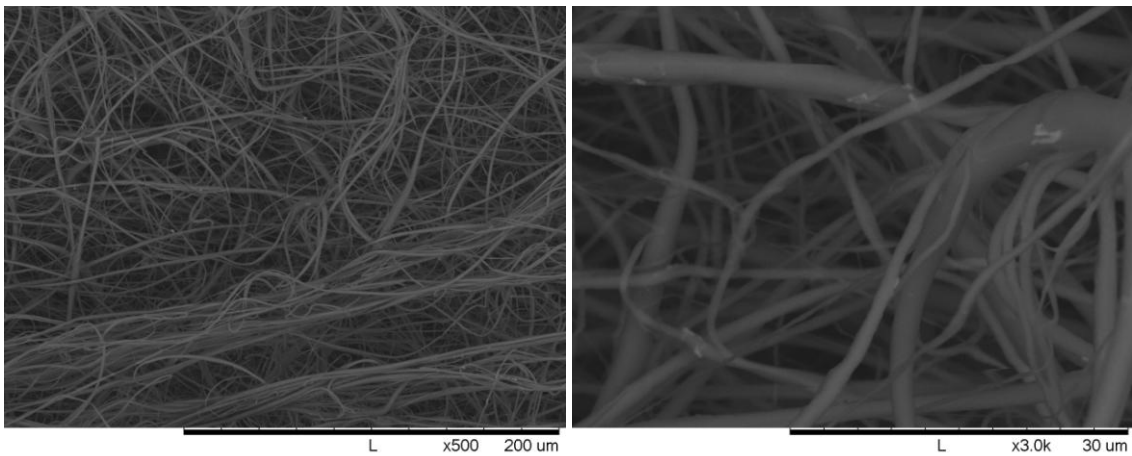

Sample 6: Sonicated 16% PVDF in DMF/Acetone solution in ratio of 2:3. Electrospun for 3 hours.

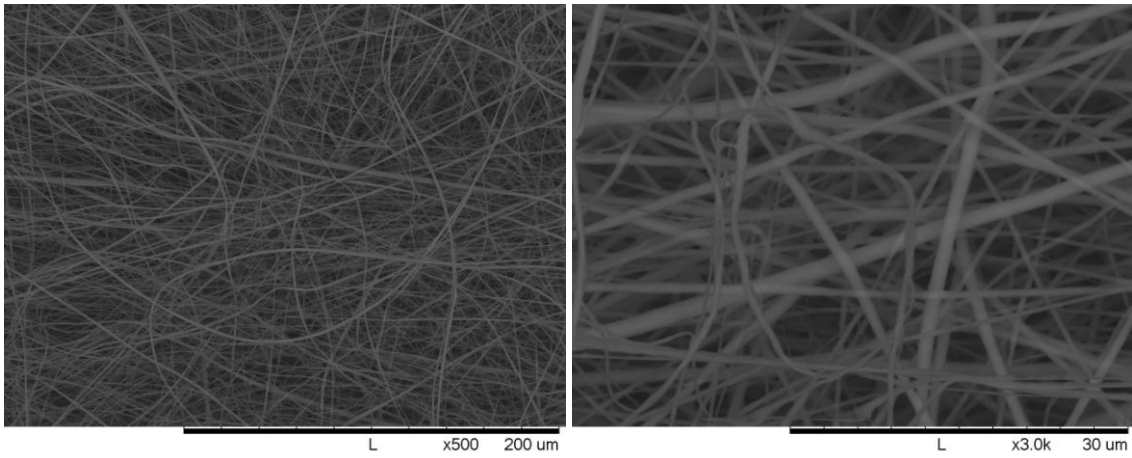

Sample 7: 16% PVDF in DMF/Acetone solution in ratio of 2:3. Double-pump electrospinning technique.

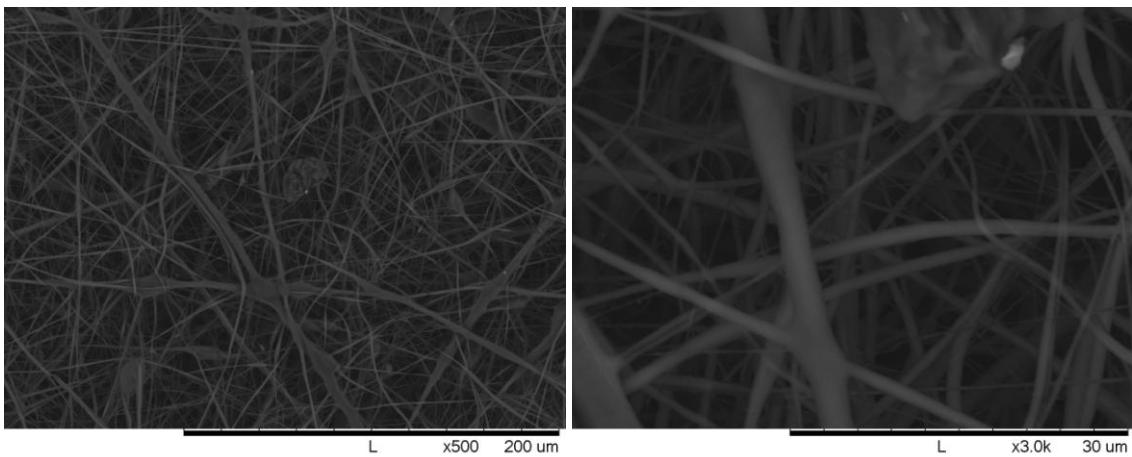

Sample 8: 16% PVDF in DMF/Acetone solution in ratio of 2:3. Yarn electrospinning. Textured yarn.

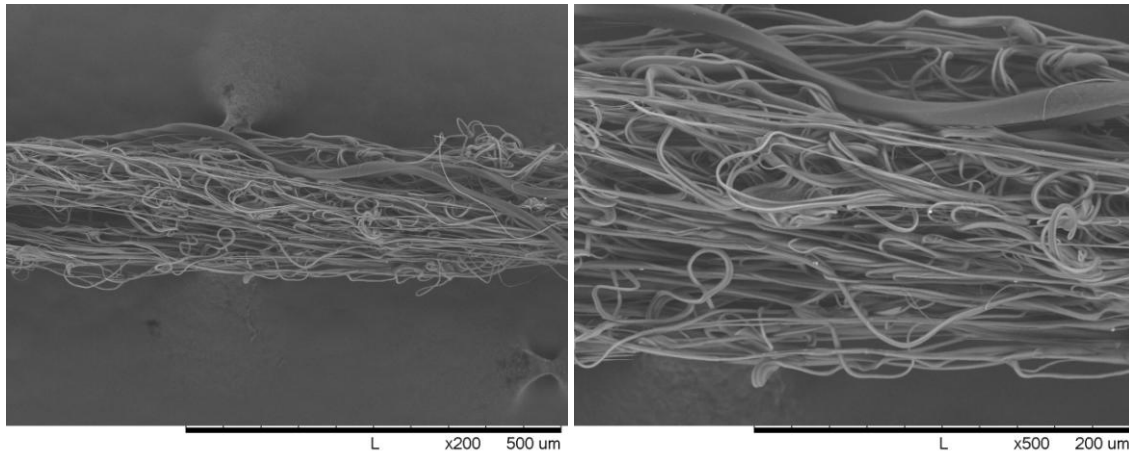

Sample 9: 16% PVDF in DMF/Acetone solution in ratio of 2:3. Yarn electrospinning. Flat yarn.

