

TALLINNA TEHNIKAÜLIKOOL

**CALCIUM-ALUMINOTHERMAL PRODUCTION OF
NIOBIUM AND UTILIZATION OF WASTES**

VALERI GORKUNOV

TALLINN 2008

THESIS ON CHEMISTRY AND CHEMICAL ENGINEERING G21

**CALCIUM-ALUMINOTHERMAL PRODUCTION OF
NIOBIUM AND UTILIZATION OF WASTES**

VALERI GORKUNOV

TUT
PRESS

TALLINN UNIVERSITY OF TECHNOLOGY

Faculty of Chemical and Materials Technology

Department of Chemical Engineering

Dissertation was accepted for the defence of the degree of Doctor of Philosophy in Engineering on November 3, 2008

Supervisor: Prof. Rein Munter, D.Sc., Department of Chemical Engineering, Tallinn University of Technology, Tallinn, Estonia

Opponents:

Prof. Leonid Jamštšikov, Physico-technical Faculty, Urals State Technical University, Russia

D.Sc Guido Rajalo, Tallinn, Estonia

Defence of the thesis: February 4, 2009 at 11.00

Lecture hall:

Tallinn University of Technology, Ehitajate tee 5, Tallinn

Declaration: Hereby I declare that this doctoral thesis, my original investigation and achievement, submitted for the doctoral degree at Tallinn University of Technology has not been submitted for any academic degree.

Valeri Gorkunov

Copyright Valeri Gorkunov

ISSN 1406-4774

ISBN 978-9985-59-877-1

KEEMIA JA KEEMIASTEHNKA G21

**NIOBIUMI TOOTMINE KALTSIUM-
ALUMOTERMILISEL MEETODIL JA JÄÄTMETE
UTILISEERIMINE**

VALERI GORKUNOV

TTÜ

Kirjastus

TABLE OF CONTENTS

INTRODUCTION.....	7
ACKNOWLEDGEMENT.....	8
LIST OF ORIGINAL PAPERS.....	9
ABBREVIATIONS.....	11
1. LITERATURE REVIEW.....	12
1.1 Early history of niobium (Nb) and tantalum (Ta).....	12
1.2 Raw materials and production of niobium and its alloys.....	13
1.3 Production of rare and rare earth metals in Estonia.....	18
2. AIMS OF THE STUDY.....	19
3. EXPERIMENTAL PART.....	21
4. MATERIALS AND METHODS.....	25
4.1 Analytical methods.....	26
5.0 RESULTS AND DISCUSSION.....	27
5.1 Calcium-aluminothermal reduction of niobium pentoxide (Ni_2O_5).....	27
5.2 Studies and elaboration of the technology for master alloys.....	32
5.3 Computation of the temperature field in the shaft furnace of aluminothermalreduction.....	33
5.4 Protective coatings for the graphite facing in calcium-aluminothermal processes.....	36
5.5 Utilization of wastes from niobium production.....	40
5.5.1 Waste slag from the shaft furnace.....	40

5.5.2 Utilization of deposits from the walls of the shaft furnace.....	42
5.5.3 Utilization of niobium wastes from metallothermal processes.....	48
CONCLUSIONS.....	51
REFERENCES.....	54
ABSTRACT.....	59
KOKKUVÕTE.....	60
APPENDIX A.....	63
PAPER I.....
PAPER II.....
PAPER III.....
PAPER IV.....
APPENDIX B.....
ELULOOKIRJELDUS.....
CURRICULUM VITAE.....

INTRODUCTION

The consumption of rare metals and rare earth metals is sharply increasing in the modern high technologies, they are actually considered catalysts of high technologies. The year 2001 was the 200th anniversary of the discovery of niobium, and 2002 marked the same anniversary for the element tantalum. Both metals have recently become vital to industry. The production and use of niobium and tantalum have increased rapidly over the last 50 years together with the development of new technologies and materials and the creation of a wide range of products made of these elements. Niobium and tantalum are used mainly in ferrous and nonferrous metallurgy, the chemicals industry, aerospace, electronics, high-energy physics (niobium), capacitor production, turbine construction, and medicine (tantalum) (Polyakov et al., 2003).

Nb alloys have been considered for use in chemical industries, especially in parts handling hot mineral acid solutions (Lupton et al., 1981). The major fraction (greater than 80%) of the world production of niobium continues to be used as steel additive in the form of Fe-Nb, particularly to high strength low alloy (HSLA) and stainless steel. Pure niobium, however, has established its use in conventional superconducting alloys like Nb-Ti and Nb₃-Sn, and as an alloy additive to structural components in nuclear reactors (Sharma et al., 1996).

Further progress in world metallurgy, especially in foundry manufacture, is also inseparably linked with the development of highly effective complex addition agents (reduction alloys, modifying agents, rich alloys). It is explained by continuously developing out-of-furnace metallurgy, when some basic operations (deoxidizing, refining and modifying) are combined with alloying and microalloying. These processes are transferred from melting furnace to teeming ladle. In this case the role of teeming ladle changes. It becomes an independent unit carrying out a number of functions, which, in many aspects, determine the quality and durability of metal.

Existing now ferroalloys, reduction alloys - modifying agents and complex rich alloys lack two essential points. They contain silicon and rather low level of calcium, rare earth metals, vanadium, niobium etc. Silicon monoxide has extremely harmful influence on properties of steel. Complex silicon free master alloys (CSMA) simultaneously with deep deoxidizing, refining and modifying provide microalloying, resulting in a dramatic (2-3 times) of all complex of mechanical and operational properties, especially plasticity, impact elasticity at usual and negative temperatures (cold resistance) and fatigue strength.

ACKNOWLEDGEMENT

I am deeply grateful to my supervisor Prof. Rein Munter for his continuous help, support and encouragement which were fundamental to the completion of this Thesis. I also wish to thank Vice Rector of Tallinn University of Technology Prof. Rein Vaikmäe and Dean of the Faculty of Chemical and Materials Technology Prof. Andres Öpik for giving me several opportunities to attend the specialized conferences in Riga and to consult with the leading specialists in the field of rare and rare earth metals technology in Russia. I am very thankful to the Head of the Materials Center of TUT Dr. Urve Kallavus for the analysis of the slag from the shaft furnace and for many valuable advices.

My special thanks for very valuable remarks and suggestions belong to Dr. A.Paršin (VNIIT, Moscow) and to Dr. A.Beketov and Dr. N.Obabkov from the Ural Polytechnical University.

Tallinn, December 2008

Valeri Gorkunov

LIST OF ORIGINAL PAPERS

I Gorkunov, V., Munter R. Calcium-aluminothermal production of niobium and mineral composition of the slag. Proc. Estonian Acad. Sci. Chemistry, 2007, **56**, 3, 142-156

II Gorkunov, V., Munter, R. Production of silicon free master alloys in Estonia. Sci.Proc. Riga Technical University „Material Science and Applied Chemistry“, Series 1, Riga, 2007, 111-120

III Obabkov, N., Gorkunov, V., Munter, R., Beketov, A. Computation of the temperature field in the furnace of aluminothermal reduction. Sci.Proc. Riga Technical University „Material Science and Applied Chemistry“, Series 1, Riga, 2007, 100-110

IV Obabkov, N., Gorkunov, V., Munter, R., Beketov, A. Protective coatings for the graphite facing in calcium-aluminothermal processes. Proc. Estonian Acad. Sci. Chemistry, 2008, **57**, 1, 54-60

V Gorkunov, V., Kogtev, M., Munter, R. Removal of mechanical additives from the surface of cast niobium. Proc. Estonian Acad. Sci. Chemistry, 2008 (*in press*).

Other publications:

1. **Gorkunov, V.**, Munter, R. Possibilities of utilization of waste slags from niobium production. Proc. International Conference EcoBalt-2007, Riga, May 10-11, 2007, 124-128
2. **Gorkunov, V.**, Munter, R. Utilization of niobium containing wastes from metallothermal processes. Proc. International Conference Eco-Balt-2008, Riga, May 15-16, 2008. 60-62.
3. **Gorkunov, V.**, Plotnikov, V., Nosikov, V. Reduction of niobium pentoxide by the carbithermal method in low temperature plasma. *Author's Certificate SU 158467*, 1980 (in Russian).
4. Primerov, S., **Gorkunov, V.**, Harin, V. Master Alloy. *Author's Certif. SU*

1238406, 1984 (in Russian).

5. **Gorkunov, V.**, Paršin A., Kogtev, M. Method of production of metallic niobium from wastes formed in the process of reduction of niobium pentoxide. *Author's Certif. SU 233207*, 1986 (in Russian)

The author's contribution:

I - Author carried out pilot plant and full scale experiments of Nb-Al calcium-aluminothermal production in a shaft furnace, collected data, interpreted results and wrote the paper together with the co-author

II - Author carried out pilot plant and full scale tests of complex silicon free master alloys of rare earths' production, interpreted the obtained data and wrote the paper together with the co-author

III - Author measured the temperature profile distribution in the wall of the shaft furnace, composed the mathematical model together with the co-authors and wrote the paper together with the co-author

IV - Author tested different protective coatings for graphite facing of the shaft furnace in industrial conditions using plasma spraying and wrote the paper together with the co-authors

V - Author participated in elaboration of the utilization technology for removal of mechanical additives from the surface of cast niobium and secondary product (niobium powder) production. He wrote the paper together with the co-authors.

ABBREVIATIONS

x and y - right angle coordinates, m

t - time, s

λ - coefficient of heat conductivity, W/m °K

ρ - density, kg/m³

C - specific heat capacity, J/kg °K

T - temperature, °K

C_{Firm} – heat conductivity of solid metal or slag, J/kg °K

Q – heat of melting of metal or slag, J/kg

T_{in} – temperature of the metal or slag after the reductive melting, °K

T_{mel} - temperature of melting of metal or slag, °K

n – direction of the outer normal to the boundary

λ - coefficient of heat conductivity, W/m °K

α - coefficient of heat transfer, W/m² °K

α_{exp} - coefficient of linear expansion, K⁻¹

β – coefficient of linear expansion, K⁻¹

T_{Sur} - temperature of the surface, °K

T_{Amb} - ambient temperature, °K

C_0 - coefficient of black-body radiation, W/m² K⁴

ε - emissivity factor of the surface

φ - coefficient of luminous efficacy

[C] – matrix of specific heat capacity

{T} – vector of key values of wanted function

[K] – matrix of heat conductivity

{F} – vector of heat load

1. LITERATURE REVIEW

1.1 Early history of niobium (Nb) and tantalum (Ta)

Discovery of both, niobium and tantalum, dates back to the beginning of 19th century. Niobium was discovered first. In 1801, Charles Hatchett (1765-1847), an English chemist, analysed a specimen of an unknown mineral from the collection of the British Museum in London. This was a heavy black mineral obtained from the collection of the first governor of Connecticut, John Winthrop. The mineral, later called columbite, was found near New London, Connecticut. Charles Hatchett declared this mineral as a 'new earth', meaning that a new element had been found. He started to call this element columbium apparently in reference to its source being America (<http://www.tanb.org/niobium1.html>). In 1809, William Hyde Wollaston, a British chemist, analysed both columbite and tantalite mineral specimens and expressed an opinion that columbium and tantalum were the same element. There was no doubt about his conclusion until Heinrich Rose, in 1844, succeeded to distinguish these two elements by their differences in valence state, with columbium exhibiting +3 and +5 states and tantalum only +5 as stable entities. Heinrich Rose renamed columbium as niobium after Niobe, the daughter of Tantalus.

Another scientist, Anders Gustaf Ekeberg (1767-1813) from Sweden, discovered and named tantalum in 1802. He investigated two minerals, one mineral became known as yttrotantalite, from Ytterby, Sweden, and another was from Kimito, Finland. The minerals of Ytterby, Sweden were of his particular interest. A. Ekeberg found that the same previously unknown element was the main component of both of these minerals. He called it tantalum after Tantalus, the son of Jupiter, who was condemned to eternal frustration and could not drink even though he was standing in water up to his neck. (<http://www.tanb.org/niobium1.html>; <http://www.rembar.com/Tantalum.htm>).

The chemical similarities of the oxides of these two elements has made it very difficult for the chemists of that time to separate them. In 1866 was developed a procedure to achieve their separation via the use of potassium double fluoride salts of tantalum and niobium. Columbium and niobium were again shown to be the same element. The names columbium and niobium were both used to identify this element for almost another century, with columbium being preferred in the Americas. It was not until 1949 that the International Union of Pure and Applied Chemistry (IUPAC) officially adopted niobium as the name for this element.

1.2 Raw materials and production of niobium and its alloys

Pure niobium (Nb) is a shiny ductile metal with a white lustre, which takes on a bluish tinge when exposed to air at room temperature ($t_{\text{melt}} = 2500\text{ }^{\circ}\text{C}$, $t_{\text{boil}} = 4927\text{ }^{\circ}\text{C}$, density $8,57\text{ g/cm}^3$ (Eljutin et al., 1973). It can have the +1, +2, +3, +4, +5 valence states. A wire with the diameter $< 20\text{ mm}$ is easy to roll a foil with the thickness of sigaret paper. At the temperatures where the steel becomes soft as wax, niobium keeps practically its initial mechanical strength. The most valuable properties of niobium are its heat, corrosion and frost resistance. The main fields of niobium application are:

- in the form of ferroniobium (50-65%) - for refractory steel production for aviation, for stainless steel in machinery, shipbuilding etc.,
- in the form of niobium pentoxide (Nb_2O_5) - for production of alloys and monocrystals of lithium niobate (LiNbO_3),
- in the form of metal - for production of electrolytical capacitors, superconductive magnets etc.

In 2006 the total amount of consumed in the world niobium comprised 32.8 thousand tons (<http://www.metaltorg.ru/analytics/publication/index.php?id=2462>). The current price for niobium ingots on the world market is 100 USD/kg, and for niobium powder (1-2 quality class) 105 USD/kg (Stuart, 2000). Superconductive magnets have been made with Nb-Zr wire, which retains its superconductivity in strong magnetic fields. This type of application offers hope of direct large-scale generation of electric power (Stallforth et al., 2000). Most of the deposits of niobium minerals are complex niobium-tantalum ($\text{Nb}_2\text{O}_5/\text{Ta}_2\text{O}_5$) type. In Table 1 the main niobium containing minerals are listed(http://www.infomine.ru/otchets/ru_niob.pdf?PHPSESSID=4c84a96bdb32ac4166c6339d5758dd99)

On the basis of information from Tantalum-Niobium International Study Center (TIC) (<http://www.tanb.org/niobium1.html>) about 90% of the niobium primary products originate from pyrochlore. The world's largest deposit is located in Araxá, Brazil and is owned by Companhia Brasileira de Metalurgia e Mineração (CBMM). The Brazilian pyrochlore contains 2.5-3.0% of Nb_2O_5 . The mining is open-cast without any need for drilling and explosives. Pyrochlore produced by another mine in Brazil (owned and operated by Anglo American Brasil Mineração Catalão) contains 18 million tonnes, but the mineral is more diluted, it contains only 1.34% of Nb_2O_5 .

Table 1. Niobium minerals

Mineral	Chemical composition	Content of Nb ₂ O ₅ , %
Pyrochlore	(Ca, Na) ₂ Nb ₂ O ₆ (OH, F)	40.5-82.5
Barium pyrochlore	(Ba, Sr) ₂ (Nb, Ta) ₂ O ₆ (O, OH)	64-67
Columbite	(Fe, Mn) Nb ₂ O ₆	57-73
Niobium rutil	(Ti, Nb, Ta, Fe) O ₂	4.5-33.5
Loparite	(Na, Ce, Ca) (Ti, Nb) O ₃	3.5-12.8

The third major deposit of pyrochlore with reserves of 18,000 tonnes, being actively mined, is the Niobec Mine in Quebec, Canada, owned by Cambior. These three companies produce about 85% of the world's demand for niobium products, with most of that output being in the form of ferro-niobium with a nominal 60% niobium oxide content, for making high-strength, low-alloy steel. (<http://www.tanb.org/niobium1.html>)

Russia with its niobium minerals is occupying the second place in the world after Brazil. The total resources of niobium pentoxide there comprise about 3.5 milj. tons (http://www.infomine.ru/otchets/ru_niob.pdf?PHPSESSID=4c84a96bdb32ac4166c6339d5758dd99). On 01.01.2007 active resources of Nb₂O₅ were estimated on 618.9 thousand tons (<http://www.mineral.ru/Facts/russia/113/110/niobiy.pdf>). The main niobium products in Russia are ferroniobium, niobium pentoxide and niobium alloys. Production of metallic niobium has remained in Kazakhstan and in Estonia. However, in 2000 in Russia only 600 ton of niobium was produced (Polyakov et al., 2003). According to Bykhovskii et al. (2001), by the year 2005 an additional source of niobium and tantalum and a partial alternative to loparite in Russia started to be the ores from Etykinskoe deposit (80-120 tons/year tantalum and 100-140 tons/year niobium). The company Severstal is planning to make and use ~ 230 tons of ferroniobium obtained from pyrochlore mined from the Tatarskoe deposit (Press Release, 2001). This is a hopeful sign, but Russia as a whole is still far from being able to meet its need for niobium (1500 tons FeNb) (Polyakov et al., 2003).

Loparite has been and still is the main raw material to produce rare earths, niobium and tantalum in Russia. Loparite is a complex titanate-tantalate-niobate of rare earths alkali metals, calcium, and strontium. Concentrate of loparite is supplied by the Lovozerskii mining-chemical factory in Murmansk area. The only customer of its products is the Solikamsk magnesium plant (<http://news.gorsnab.ru/news/news6508.html>).

On the territory of Western Kazakhstan is situated Irtyshkii chemical-metallurgical factory (ICMF), nowadays JSC, who after collapse of the Soviet Union switched quickly over to rare and rare earth metals and their alloys production. The raw material comes from the USA, and a very high quality niobium (99.95-99.96%) made in electric-arc furnaces is exported back to the USA (<http://www.mining.kz>). Close to ICMF in Kazakhstan is situated another big factory - Ulbinski metallurgical factory. Technology applied (treatment with HF and H₂SO₄ acids) enables to extract niobium and tantalum from practically every raw material. Precipitation of potassium fluortantalate is carried out with KCl. Niobium hydroxide separated from the niobium phase of the separative extraction is washed, dried and calcinated to produce niobium pentoxide (<http://www.kazatomprom.kz/cgi-bin/index.cgi?f6&version=ru>). Differently from some other similar factories the problem with process wastes is solved here. The factory has a well developed hydrometallurgical production unit and about 30% of wastes are included into its cycle. Wastes with high content of the metallic phase (30-40%) are recycled to the remelting process, and the remaining part is passed through the stage of oxidative combustion and recycled back to the main process.

Niobium oxide (Nb₂O₅) is generally the starting chemical for the production of other compounds, such as niobium chloride (NbCl₅), niobium carbide (NbC), or lithium niobate (LiNbO₃). Niobium metal is produced by the aluminothermal reduction of the oxide followed by electron beam refining. In the facilities described above the pyrochlore mineral is processed by primarily physical processing technology to give a concentrate ranging from 55 to about 60% niobium oxide. The concentrations of Nb₂O₅ in enriched ore concentrates are: in pyrochlore ores it is no less than 37%, in loparite 8% and columbite ores contain 30-60% Nb₂O₅. Columbite, a mineral with a ratio of Nb₂O₅:Ta₂O₅ ranging from 10:1 to 13:1, occurs in Brazil, Nigeria, and Australia, also other countries in central Africa. Niobium is recovered when the ores are processed for tantalum.

To process loparite two methods were used in Russia: 1) extraction method implying sulfuric acid leaching and further multi stages separation of rare earths, niobium, tantalum, and titanium products. This technology was also used at the chemical-metallurgical factory in Sillamäe (now Silmet JSC); 2) chlorine method utilized by Solikamsk factory in Russia. Silmet JSC stopped loparite processing in 1992.

Thus, in principal, niobium metal can be produced by the aluminothermic method or using caustic or carbonate fusions of reduction of the oxide. First methods include carbide processing from the mixture of Nb₂O₅ and cinder at 1800°C in hydrogen atmosphere; then the mixture of pentoxide and carbide is recovered at 1800-1900°C in vacuum until niobium metal. The other methods for niobium extraction from FeNb involve caustic or carbonate fusions, which when leached or washed, give niobium oxide which is fairly pure and may be further

purified by chlorination or other means. Ultimately, the oxide must be metallothermically reduced as previously described, or carbothermically reduced to niobium metal. Niobium powders can be produced by the reduction of potassium niobium heptafluoride (K_2NbF_7) with sodium or by the reduction of niobium oxide with magnesium (<http://nb-niobium.info/production.html>).

Two separate processing schemes are nowadays utilized for niobium production in big companies. Those companies that mine pyrochlore convert the niobium oxide units into ferro-niobium through the aluminothermic reduction process or by reduction in an electric arc furnace. Reductive refining in an electric arc furnace makes it possible to reduce the consumption of aluminium and avoid having to use additions of hematite, fluorspar, and sodium nitrate (Polyakov et al., 2003).

Companhia Brasileira de Metalurgia e Mineracao (CBMM) has installed capacity for the production of a high purity oxide that can be used to produce vacuum grade ferro- and nickel-niobium as well as niobium metal ingots via electron beam refining. The recently improved technology not only allowed CBMM to obtain certificates of quality for its ferroniobium and high-purity niobium oxide, but also to debunk the myth that pyrometallurgical processes are by nature environmentally harmful. In 1997, the CBMM became the first factory in the mining-metallurgical sector in the world to be certified as meeting the requirements of the standard ISO 14001 (Sousa et al., 2000).

If to use tantalum-bearing ores, such as tantalite, as feedstocks then it is needed to process these materials chemically. The purified niobium-containing process stream is generally converted to niobium hydroxide $Nb(OH)_5$ by the introduction of ammonia, followed by washing, filtration, and calcining to the oxide. Purities exceeding 99.99% can be achieved. Hydrometallurgical methods of processing tantalum-niobium concentrates have serious problems - permanent loss of reagents with the ballast of the raw material, dissolution of impurities, huge costs associated with regeneration of fluorine and despite of that its substantial losses, formation of solid wastes in an amount more than an order of magnitude greater than the quantity of useful products. (<http://www.tanb.org/niobium1.html>).

In (Okabe et al., 1999) a new method for niobium powder production was explored - an electronically mediated reaction (EMR) route using calcium as a reductant for niobium pentoxide. Feed material, Nb_2O_5 , and reductant calcium alloy containing aluminium and nickel were charged into electronically isolated locations in a molten salt ($CaCl_2$) at $1173^\circ K$. Niobium powder with low aluminium and nickel content was obtained, although liquid Ca-Al-Ni alloy was used as the reductant.

In producing modern materials based on niobium and tantalum, metallurgy is gradually entering the realm of high technology. For example, a method now being

developed to make niobium capacitors (Reichert, 2002) includes the successive operations of reducing Nb_2O_5 to NbO_2 with hydrogen, reducing NbO_2 to NbO in the presence of catalyst, and then reducing NbO to niobium in manganese vapor. In contrast to the traditional single-stage metallothermic process that takes place very rapidly at high temperatures in the reaction zone, this process makes it possible to monitor and control the conditions under which the chemical reactions occur and to obtain high characteristics in the final product. The niobium powders obtained by the new method are characterized by high purity, and a specific surface up to $10 \text{ m}^2/\text{g}$.

Ferrous and non-ferrous metallurgy, especially casting industry, use high-efficient complex alloying additions (deoxidizers, modifiers, alloys) which are produced involving the rare earth metals. The term „rare earths“ is used to describe a group of 15 elements on the periodic table from atomic number 57 to 71. The most common rare earth elements are neodymium (Nd) and yttrium (Y). From the discovery of the rare earth elements (REE) (during the period 1794-1907) through the mid-1950s, a few of the REE were produced in modest amounts from monazite-bearing placers and veins, from pegmatites and carbonatites, and as minor byproducts of uranium and niobium extraction. During this time, the middle and heavy REE generally were available in pure form only in sub-kilogram quantities and were chiefly chemical curiosities (<http://pubs.usgs.gov/fs/2002/fs087-02>).

There is large amount of reserves of rare earth minerals in the world: Baiyun Obe iron-niobium-rare earth deposit in Inner Mongolia in China, bastnaesite deposit in Sichuan in China, ion adsorption clays in Southern provinces in China, Mount Weld monazite desposits in Australia, bastnaesite deposit at Mountain Pass in USA, Zaislagushi rare earth deposit in Brazil, Tuomutur rare earth deposit in Russia, Maosai rare earth deposit in Vietnam etc. (<http://www.beyondchem.com/rareearth.htm>). China mining quantum of rare earths in 1995 accounted for 70% of total production in the world.

Loparite has been the main raw material to produce rare earths, niobium and tantalum in Russia. To process loparite two methods were used: 1) extraction method implying sulfuric acid leaching and further multistages separation of rare earths, niobium, tantalum, and titanium products. This technology was used at the chemical-metallurgical factory in Sillamäe (now Silmet JSC); 2) chlorine method utilized the Solikamsk factory. Silmet JSC stopped loparite processing in 1992. Thus, Solikamsk Magnesium Works became the only company in former USSR involved in such production processes.

Master alloys on the basis of Ni, Co, V and Nb containing the rare earths such as La, Ce, Pr, Nd and Yb enable to solve the problem of the heat-resistant steel and non-ferrous metals production. Research-and-production company „Russian rare

metals“ has engineered technology and set production of silicon-free complex modifiers (CSMA) the basis of rare earth metals, nickel and iron. According to the experts estimation modifiers demand in Russia counts for 5000 tons per year.

In the United States a process for the production of rare earth metals and alloys has been invented which exploits the known advantages of metallothermal reduction techniques while decisively enhancing their reduction process. Rare earth halides and/or rare earth oxides are reduced in an electric arc furnace by means of one or several alkaline earth metals, preferably, calcium (US Patent 4786319).

1.3 Production of rare and rare earth metals in Estonia

Silmet JSC, located in the northeast of Estonian Republic, is one of the biggest companies in Europe in rare elements production, holding the third position in the world on metallic niobium production capacity. At the present time Silmet JSC produces about 20% of the global amount of niobium (<http://www.silmet.ee/>). There are three separate plants in operation at Silmet JSC (http://www.giredmet.ru/obzory/rare_2006.html):

- plant of the rare earth metals
- plant of the rare metals
- metallurgical plant

Majority of the worlds rare earth metals are produced in China, Silmet JSC with its 5% market share is actually the sole alternative to China for all consumers needing rare earth metals. The uses of some rare earth metals (lanthanum, cerium, yttrium etc.) are also remarkable. The raw materials of rare earth metals mainly come from Russia, from the Kola Peninsula. Pretreatment processes take place in Solikamsk, further processing in Sillamäe. The production is exported to several countries, mainly to Japan, where most of the consumer industries in the world are located (<http://www.tbr.ee/issues/vol20/silmet.html>).

Silmet has been operating on the Southern Coast of the Gulf of Finland for almost a century. The first information about business activities here dates back to 1928. After World War II Silmet became an important closed military factory for the former Soviet Union, where in 1946 even processing of uranium was introduced. In 1970, processing of rare metals and rare earth metals was started. First, loparite from Kola Peninsula was used as raw material. Today the plant is using rare earth concentrates imported from Russia and China as a raw material for the rare earth metals production. In rare metals production raw material from Brazil, Africa and China is used. In 1997 Silmet was fully restructured and privatized – a JSC Silmet was established. In 2004 Silmet JSC was granted international quality certificate ISO 14001:1996. By this time Silmet JSC had

established almost its own feed-stock basis satisfying 80% of the need for raw materials. Since 01.01.2008 the General Director of Silmet JSC is Dr. Anti Perkson. Taking over this responsible post he declared in his speech:” *I consider my new job as a task and opportunity to keep the position of the world leader in production of Ta, Nb, REM....., outside of the dependence on chinese raw materials*” (<http://www.silmet.ee/default.aspx>).

Elaboration of the alumo-calcithermal method for niobium and complex silicon free master alloys (CSMA) production under laboratory and pilot plant conditions in 80-90-ties in the USSR was accomplished at chemical-metallurgical company in Sillamäe first. Successful developments in a new technology enabled at the end of 90-ties to produce at the factory the CSMA ingots with the weight of 500 kg per one melting. The author of the present Thesis was in 80-90s involved in elaboration and optimation of the out-of-furnace processes of the niobium and CSMA production where significant attention was also paid on different process wastes utilization. The research results were assembled in several scientific reports and some of them were also protected by the Author’s Certificate of SU. Technological solutions introduced at Silmet JSC turned out environmentally friendly and economically efficient. The main results of these studies are hereby presented for the defence of the degree of Doctor of Philosophy in Engineering (in Chemistry and Materials Technology).

2. AIMS OF THE STUDY

The main objective of the present doctoral thesis has been to study and optimize the „out-of-furnace“ process (i.e. without external heat access) of calcium-aluminothermal production of niobium and CSMA in a shaft furnace in chemical-metallurgical company in Sillamäe, to find technical solutions for protection of the graphite facing and for utilization of slag and niobium containing wastes.

To achieve this target, the process of calcium-aluminothermal reduction of niobium pentoxide (Ni_2O_5) was studied under pilot plant and full scale conditions, the Ca/Al ratio in the raw materials mixture was varied to achieve the product (Nb-Al alloy) of the best quality. To propose the possible solutions for the waste slag utilization, its mineral and phase composition were determined.

The second objective was to carry out laboratory studies, pilot plant tests and full scale meltings for elaboration of technology of rare earths` (RE) master alloys production. In the process of niobium and rare earths’ master alloys production by the „out-of-furnace“ method in a shaft furnace the temperature is in the range of 2000-2900°C. The facing of the furnace is made of graphite. To elaborate the composition of powders and technology of plasma spraying of protective layers for graphite facing, composing of the mathematical model and computation of the

temperature field inside of the shaft furnace was required. This was the third objective of the study.

In the process niobium alloys and niobium master alloys production two products are formed: alloy of niobium with aluminium or with RE metal, and slag ($n\text{CaO} \cdot m\text{Al}_2\text{O}_3$) having usually a quite clear interfacial area. The slags, which contain calcium aluminates, are considered as a source of valuable raw material for the production of fast-setting and very strong cements. The fourth objective was to study the formation, mineral and phase composition of the waste slag to estimate the possibilities of its utilization. In the process of niobium pentoxide reduction in the shaft furnace on the graphite facing, in the zone of occurrence of reactions and precipitation of molten products, a layer of deposit is formed as a result of physico-chemical actions between the compounds of the raw mixture, reduced metal and slag with graphite. On the other side, niobium ingots produced in the shaft furnace will pass the remelting process (refining) in the electron-beam furnace. During the refining niobium vaporization and vapours condensation on the inner surface of the electron-beam furnace, cooled down by cold water, occurs. Elaboration of the utilization technology for these niobium containing wastes was the fifth objective of the present study.

3. EXPERIMENTAL PART

The full scale shaft melting furnace is made of steel and supplied with a specific graphite facing inside, with a system of ventilation and hermetization, and Ar gas input. In Fig.1 (*Fig.2, Paper I*) the construction of a shaft furnace for melting of 500-2000 kg of ingots is shown.

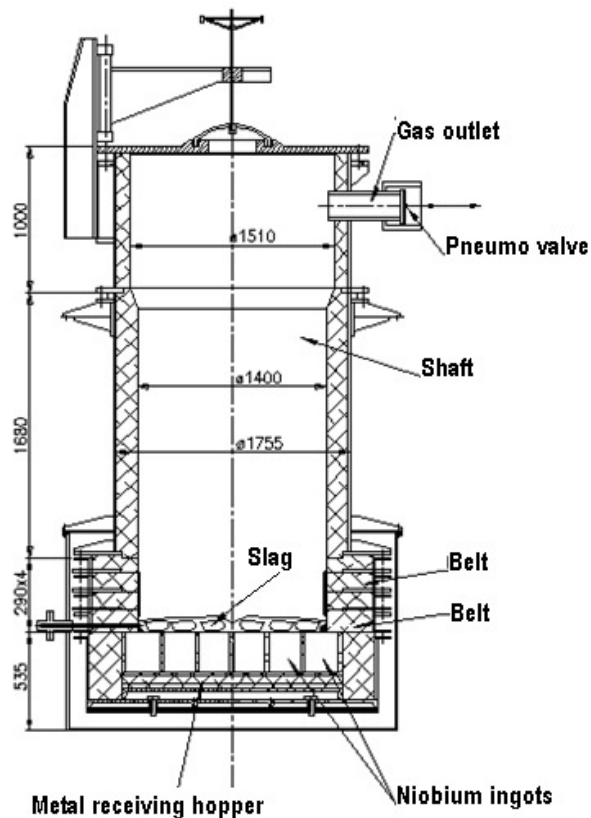

Fig. 1. Shaft furnace for master alloys and melts production.

As a result of the reduction reactions alloy of niobium with residual aluminium and slag (calcium-aluminium oxides) are formed. In Fig.2 (*Fig.1, Paper I*) the Nb-Al ingots and metal niobium are shown.

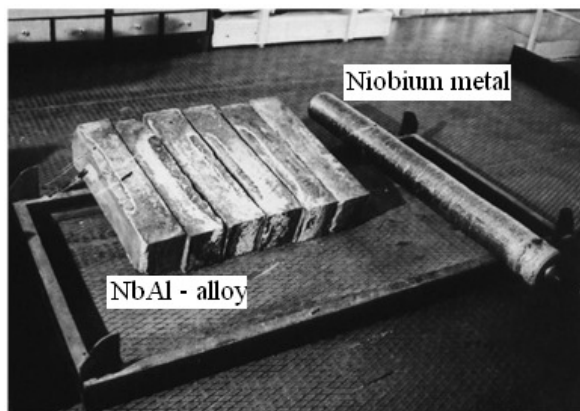

Fig. 2. Niobium ingots and niobium metal

Technology of calcium-aluminothermal reduction of niobium pentoxide enables to produce the alloy in the form of compact ingots with the content of aluminium < 5% (mass). The process proceeds in the area of aluminium solid solution formation in niobium.

The initial compounds (Nb_2O_5 , Ca, Al) are mixed in a stainless steel container with a special discharge hatch and transferable centre of rotation during 20-25 min first. Nb_2O_5 and Al are in the form of powder and Ca is used in the form of chips. This equipment ensures even mixing of the compounds of different density, size and configuration. Container and discharge hatch were made of a special sparkless steel to avoid sparkling at accidental strokes or at friction of mixed compounds (*Paper II*).

The raw mixture is loaded into the shaft furnace through the upper boot. On the surface of the mixture an incendiary of the initial compounds of the raw mixture is placed and the furnace is hermetized. After that in the space of furnace vacuum (residual pressure < 100 mmHg) is created, and the space is filled up with inert gas argon. The reaction is initiated by a special ignition facility (electrical spiral) on the inner side of the upper cover of the furnace. During the melting process the ventilation system for hot gases removal with the following equipment of gaseous emissions treatment is switched on.

The reduction reaction proceeds with a significant temperature gradient (from room temperature to 2900°C) in a few minutes (~ 5-6 min). The furnace is designed taking into consideration a steep increase in temperature and pressure to avoid the graphite facing decomposition. Physical properties of graphite depend on the orientation of the particles of coke from which it was formed by pressing. Graphite of grade GMZ applied for facing of the shaft furnaces, in produced by the method of extrusion, and like other materials, made by this method, has clearly exhibited anisotropic properties. Grains are oriented strictly perpendicularly to the direction

of pressing and able to resist to big mechanical loads at higher temperatures and also at steep temperature falls. Graphite is a great facing material for high-temperature „out-of-furnace“ process, its coefficient of thermal expansion is $4.45 \cdot 10^{-6} \text{ }^\circ\text{C}^{-1}$ (Ubbelode, 1965). The main disadvantage of graphite is its increased chemical activity at higher temperatures. Graphite reacts not only with oxygen of air, but also with molten metal as well as with slags.

Liquid metal (niobium) is precipitated, passing through the slag layer and fulfilling the metal receiving hopper, the slag on its surface, which after 3-4 min of retention flows out into the receiving scoop. The mass of ingots comprises from 500 to 2000 kg per melting.

Experimentally measured velocity of sedimentation of the liquid drops of Nb-5%Al alloy with the radius of ~ 1 mm in the slag is 1.5-1.7 cm/s (i.e. about 17 kg/s). Calculated sedimentation time of these drops and estimation of possible changes in this value in the slag with the composition of $3\text{CaO} \cdot 5\text{Al}_2\text{O}_3$ indicated that the period of the drops accelerated motion is so short that their velocity can be considered permanent along the whole route of sedimentation. Correspondingly, the sedimentation velocity of the liquid metal drops can be calculated from the Stokes equation (Ljakišev, 1978):

$$v_0 = \frac{2}{9} \frac{r^2 g (\rho_2 - \rho_1)}{\eta} \quad [1]$$

where

r – radius of the metal drop;

g – acceleration

ρ_2 – density of the metal drop;

ρ_1 – density of the slag

η - viscosity of the slag

The necessary condition for the Stokes equation application is a laminar regime of the liquid drop's motion. This equation is valid only when the resistance of the slag phase is proportional to the velocity of the liquid drop's motion. If the critical velocity of sedimentation exceeds the resistance of the slag phase, the laminar motion turns to turbulent one. This state is described by the equation of Puaseille` (Raist, 1987):

$$v_{max} = Re \frac{\eta}{\rho_2 r}, \quad [2]$$

where Re – Reynolds number

If to take for the sedimentation velocity and duration of the process calculation the radius of the liquid drop 0.15 mm, then the velocity of sedimentation is 1.5 cm/s, and the first layer of metal with the thickness of 10-15 mm is formed in the metal receiving hopper in 10-20 s, passing through the slag layer with the thickness of 500-600 mm.

According to the general theory of motion of solid and liquid particles in the solution of electrolytes (Nigmatulin, 1987), the velocity of the liquid drop's motion in the melt is influenced by the tangential component of velocity at the interface drop-slag. In the falling drop a swirling flow of liquid is created which causes in the lower part of the drop the centrifugal motion of the liquid particles from the center to the surface, and in the upper part the opposite phenomenon. As a result the difference in electrical potentials between the lower and upper parts of the drop is created, and tangential motion of the liquid particles in the drop is decelerated. Theoretical calculations have indicated that the deceleration takes place only up to the certain critical radius of the drop (r_{crit}). Drops with the radius $> r_{crit}$ are settled with the velocity according to the equation of Adamar-Rjabštšinski (Nigmatulin, 1987). The critical radius (r_{crit}) can be found from the equation:

$$r_{\text{крит}} = \sqrt{\frac{3\Delta\sigma_{\text{max}}}{2g(\rho_2 - \rho_1)}}, \quad [3]$$

where σ_{max} - change in surface tension due to the increase of the surface concentration of charge.

Supposing σ_{max} equal to 20% of the surface tension at the interface metal-slag, average difference $(\rho_2 - \rho_1) \approx 3 \text{ g/cm}^3$, and average surface tension 1 N/m, one can obtain $r_{crit} = 0.3 \text{ cm}$. According to the literature data (Ljakišev, 1978), the laminar motion of the liquid drops is maintained up to their radius of $< 0.5 \text{ cm}$. It means that in the melting process in a shaft furnace in Fig. 1 we have the laminar motion of the liquid metal drops. Later, analyzing the samples of the slag from the different parts of the furnace, it was found that the size of the drops depended on the size of the particles of niobium oxide and reductants and was in the range of 0.15-0.35 mm.

4. MATERIALS AND METHODS

Only a very short description of the materials used and analytical procedures applied is given in this section. For more details see the experimental part in *Papers I-V*.

At chemical-metallurgical company in Sillamäe as an initial raw material for the pilot plant tests and full-scale meltings niobium pentoxide (Nb_2O_5) of grade B or C, produced by the factory itself for the external market, has been used (min 99.2% of Nb_2O_5) (*Table 1, Paper I*). Chemical and granulometric composition of powdered aluminium and metallic calcium chips used at the pilot and full scale meltings is given in *Table 2, Paper I*.

For production of complex silicon free master alloys (CSMA) with rare earths were used: fluorides of rare earths, cesium (Ce) and ytterbium (Yb), aluminium powder and chips of metallic calcium. The cesium fluoride produced at Sillamäe factory contained total rare earth oxides (TREO) 84.3% (*Paper II*).

Mixing cycle of raw materials here was accomplished in the same way as for niobium alloys production (*Paper II*). Prepared raw materials mixture from the container was directly loaded into a graphite pot (pouring ladle) of the volume of 0.4 m^3 placed into the chamber with a ventilation system. In the chamber a normal atmospheric pressure was kept. The process of reduction was quite fast and lasted no more than 250-300 s. The liberated heat guaranteed full melting of the products (*Paper II*). Melted liquid slag constituted a good protective layer for the reduced metal from oxidation and reaction with oxygen and nitrogen of air. Cooling of the reaction products down to 60-80 °C took at least 4.0-4.5 hrs. The melt was easy grindable to the needed size of grains (*Paper II*).

The main aim of this work was to study the operation conditions of the graphite facing of the furnace during the reductive melting process and to elaborate effective composition and suitable technique for spreading of protective coatings on graphite. Another important task was to find solutions for the process wastes utilization.

As initial materials for the plasma spraying of protective layers for graphite facing the powders containing zirconium dioxide, stabilized by calcium oxide, technical aluminium oxide, metallic niobium and niobium carbide were used. Composite cermet layers $\text{Al}_2\text{O}_3 + \text{Nb}$, $\text{ZrO}_2 + \text{Nb}$ and $\text{NbC} + \text{Nb}$ were covered by spraying with mechanical mixtures of powders Al_2O_3 , ZrO_2 , NbC , Nb , and with special composite conglomerated powders $\text{NbC} + \text{Nb}$. The thickness of different coatings given above was 0.3-0.5 mm. Initial materials were dried, grinded, granulated and classified to get the powders with particle diameter of 40-120 μm (*Papers III-IV*).

Subjects of the niobium utilization studies were typical deposits from the inner walls of the shaft furnace, containing metal and slag phases together with mechanical additives of graphite as well as niobium wastes formed in the process of refining remelting of niobium-aluminium alloys in electron-beam furnace. The following utilizing procedures for the deposits were carried out (*Paper V*):

- thermomechanical treatment of the deposit at the temperature of 900°C for removal of the slag and graphite,
- hydrogenation of metal,
- grinding of the metal hydride to powder in a vibrating mill in the atmosphere of inert gas,
- separation of hydride powder in a gravitational apparatus (on a concentration table) from non-metal product

4.1 Analytical methods

Structural studies of NbAl-alloys (ingots) obtained in the melting process were carried out by the methods of optical metallography using microscope NEOPHOT-21 and scanning electron microscope REM-100U. The samples of slag were taken during the melting tests from different points of the “slag field” and were blanked using cutting blade. One of the specimen’s surface was polished. Also the samples grinded to fine-grained powder were analyzed.

The chemical composition of slag was determined by the methods of wet chemical analysis first. The density of the slag was determined according to the buoyancy method (Archimedes principle), the viscosity was measured by the rotational method, and surface tension by the maximum-bubble-pressure method (Arsentjev et al., 1988). The slag from the optimum reduction process with the composition of $3\text{CaO}\cdot 5\text{Al}_2\text{O}_3$ (i.e. with a minimum relative amount of Al:Ca) was analyzed recently in more detail in the Zeiss Demo Lab in Cambridge, UK as well as in chemical laboratory of Silmet JSC (*Paper I*).

Analytical equipment used in the pilot plant and full scale studies of complex silicon free master alloys (CSMA) production was the following: electron microscope JSM-35CF („JEOL”), roentgen microanalyzer of energy dispersal type Link 860, diffractometer Geigerflex-D/max-RC („Rigaku”), and unit of cathode disintegration JFC-1100 („JEOL”). Elementary analysis of the slag phase was carried out by the method of electroprobe microanalysis, and of the produced CSMA melt by the roentgen fluorescent method on the spectrophotometer PHILIPS RW 1220 (*Paper II*).

Phase composition of the protective coatings was studied by X-ray diffractometer DRON-2 with monochromatic copper k-alpha irradiation at a wavelength of 1.5418 Angstroms. Microstructure of the contact zone graphite-coating was investigated by metallographic analysis using microscopes MIM-7

and MIM-9. Strength of the contact zone was determined on a special equipment PMT-3 (*Paper IV*).

The process of non-isothermal oxidative combustion of niobium wastes from electron-beam furnace was followed on thermogravimeter „Du Pont 1090”, and the isothermal combustion was proceeded in muffle and shaft furnaces at the maximum temperature of 1200°C. Composition of initial and final products was established by chemical and diffraction analyses (DRON-3M). Shape and particle size of the metal powder was established under electron microscope JEOL JSM-840.

5. RESULTS AND DISCUSSION

5.1 Calcium-aluminothermal reduction of niobium pentoxide (Ni₂O₅)

The basic technology of rare metals manufacture is aluminothermal reduction of metal oxides (Berg et al., 1979; Gorkunov et al., 1986; Pliner et al., 1967) (*Paper I*):



At Sillamäe chemical-metallurgical factory (Silmet JSC) the two reducers, metallic powdered aluminium and chips of metallic calcium, started to be used in the previous USSR first, and the reduction process corresponded to the following prevailing reaction:

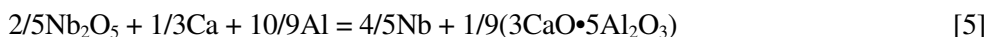

Mechanism of metallothermal reduction processes has not been sufficiently studied yet. These processes are complicated due to the fact that the reagents, for example calcium, may be simultaneously in two different aggregation states, in liquid and in vapour one. As a result of the reduction reaction [5] the two products are formed: alloy of niobium with residual aluminium and the slag (calcium-aluminium oxides), having usually a quite clear separation or interfacial area

According to the Nb-Al phase diagram (Handbook, 2001), if the specific heating effect is very high, at the temperature of 2400°C a Nb-Al alloy is formed which contains about 97% of Nb.

Characterizing the whole process in the furnace, the three metals are involved here (melting temperature and standard electrochemical potential are given in brackets): niobium (2468°C; 0 V), and the reducers calcium (851°C; (-2.76 V)), and aluminium (660°C; (-1.66 V) (Volskii, 1968; Clark et al., 2002). The most energetic reducer is

calcium which has the lowest negative electrochemical potential among of the known metals (*Paper I*).

Niobium ingots must have a high mechanical strength for the next remelting process (refining) in electron-beam furnace. In the world practice alloys with aluminium content > 20% are prevailing, however, in these conditions intermetallides Nb₂Al and Nb₃Al are formed. Alloys are fragile and easy to crush. At the chemical-metallurgical company in Sillamäe a different technology leading to the formation of the “plastic” alloys, resistant to heavy burden and crushing was developed. In these alloys aluminium content does not exceed 5%. Formation of the “plastic” alloys of niobium with aluminium is possible at higher temperatures (up to 2400°C) (*Fig.3, Paper I*). To increase the temperature of the process, metallic calcium as a reducer is added:



The exothermic heat of this reaction is 510 kJ/mole, and the specific exothermic heat is 106 kJ/g-atom of raw mixture. At the same time the specific exothermic heat of the reaction [4] is only 86.1 kJ/g-atom (Zelikman et al., 1990). Changing the ratio of calcium and aluminium it is possible to increase the exothermic heat of the reduction reaction significantly comparing to the effect of the reaction (4), and to reduce the melting temperature of the slag.

Important is that differently from aluminium, calcium does not dissolve in niobium and, consequently, does not pollute it. A similar technology with addition of iron as an additional reducer has been developed in the USA (Zelikman et al., 1990), however, to get rid of iron compounds in the remelting process later is very complicated.

Oxides of calcium and aluminium can form series of different compounds in the slag. The average composition of the aluminium-calcium flux (slag) at Silmet JSC is nowadays the following: 65-75% Al₂O₃; 25-30% CaO and 3-5% Nb₂O₅ (<http://www.silmet.ee/>)

According to the equation [5] the prevailing compound of the slag is 3CaO · 5Al₂O₃. Maintaining of this mineral composition of slag is a very important technological parameter, as it determines the viscosity and surface tension of the slag and has direct impact on fulfilment of the reduction process and clear separation of phases.

During the reduction process of niobium pentoxide at high temperatures in the zone, where chemical reactions and precipitation of molten products occur, a system of graphite-NbAl alloy-slag is formed (*Fig.3*).

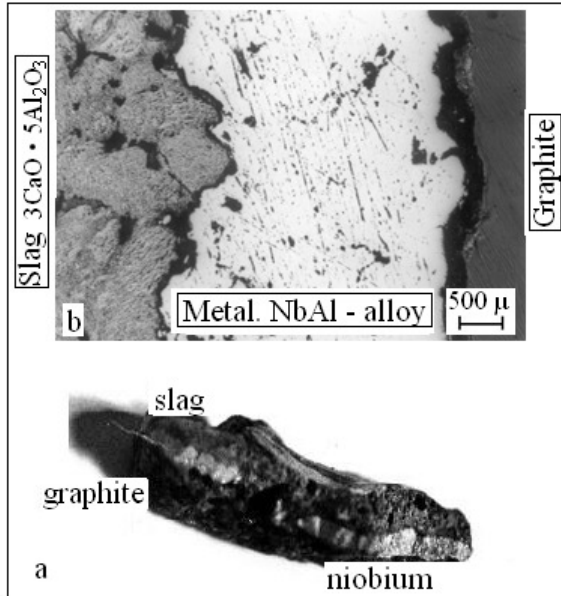
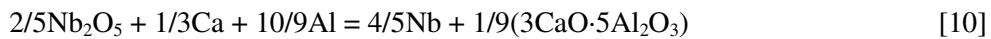
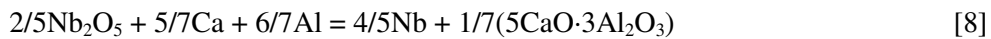

Fig.3. Photo of the fragment of deposit (a); microstructure of the system graphite-NbAl alloy-slag. The main compound of slag is $3CaO \cdot 5Al_2O_3$ (b)

Using a double reducer Al-Ca in the process of Nb_2O_5 reduction is a positive factor from the point of view of formation of CaO, which enables to achieve favourable impact on such kind of important physical parameters of the system as viscosity, density and surface tension between metallic and slag phases.

During the pilot and full scale studies in a shaft furnace it was established that in the process of Nb_2O_5 reduction with double reducer Al-Ca the following reactions proceed leading to the formation of slags with different composition (Tables 3 and 4, Paper I):



Phase diagram of the system CaO-Al₂O₃ is shown in (Fig. 5, Paper I). It can be seen that at higher temperatures (> 2000°C) Al₂O₃ does not form mixtures with CaO. Starting from 1700°C different solid solutions of Al₂O₃ with CaO are formed (CaO·6Al₂O₃; CaO·2Al₂O₃), and at 1600°C the solid solution 3CaO·5Al₂O₃ with minimum relative amount of Al₂O₃/CaO is formed. Selection of the optimum ratio of Ca/Al for the reduction process was focused on slag formation with lower melting temperature. Series of pilot and full-scale melting tests enabled to find the optimum composition of the raw mixture to obtain as much as possible pure niobium ingot with Al content < 5% and slag with minimum residual content of Nb₂O₅ (Table 3, Paper I).

For reduction of 1 mole of niobium pentoxide 200 kg of Ca were taken which are equivalent to 90 kg of Al. From (Table 3, Paper I) it can be concluded that these requirements are fulfilled at the ratio of Ca/Al = 0.45 in the raw materials mixture best and at the reducers excess of 10%. Under these conditions the content of aluminium in the NbAl-alloy is minimum – 4.4% with the content of residual Nb₂O₅ in the slag 2.8-3.0%. The slag's composition corresponds to the formula 3CaO·5Al₂O₃ with the melting temperature of 1720°C (second row in Table 3, Paper I).

It was found that from the reactions [4-7] in (Table 4, Paper I) the desired one is the 7th reaction with the 10% excess of reducers, where the consumption of calcium was optimal, a good separation of metallic and slag phases took place, the content of the residual Nb₂O₅ was minimal, and the produced ingot was of very good quality, compact and plastic. It was established that addition of metallic Ca to the raw materials mixture with 10% of excess enabled to reduce the Al content in ingot to 5% or less and increase the Nb content (Fig.6, Table 5, Paper I).

Strengthening of the metallic niobium ingot and increase in its plasticity in pilot plant and full scale meltings proceeded due to the formation of the solid solution of aluminium in niobium and diminishing of the content of the fragile phase of intermetallides. Microstrength of the ingot was 600 ± 100 kg/mm². The structure of the alloy with the 4.5% aluminium content in the field of X-rays is shown in (Figure 7 (a,b), Paper I). The alloy contains a solid solution of aluminium in niobium with insignificant amount of intermetallides Nb₃Al. The main mass of the ingot has a uniform structure corresponding to the solid solution. Introduction of the results of the pilot plant melting tests into practice led to the excellent parameters of the industrial NbAl-alloys with mass up to 2000 kg (Table 6, Paper I).

The main mass of the slag was made up of 3CaO·5Al₂O₃ (Fig.8, Paper I).The most important physico-chemical parameters of the slag are viscosity (μ), surface tension (σ) and density (ρ). Slags from niobium out-of-furnace production are called „short“ as they have a relatively short temperature interval of steep viscosity drop at the temperature increasing and vice versa - a relatively short temperature

interval of steep viscosity growth at the temperature decreasing. Relatively low viscosity of the slag creates better conditions for the sedimentation of the liquid metal droplets through the layer of slag. According to the measurements increasing of the content of CaO in the slag decreases its viscosity.

The values of the surface tension (σ) of calci-aluminothermal slags given in literature are controversial, however, different authors agree in opinion that the losses of metal in the form of small metal droplets „lost“ in the slag depend not only on the difference in densities between metal and slag, but also on the surface tension. The surface tension and density of slag were measured in this study by the maximum-nitrogen bubble-pressure method. Experiments showed that increase in CaO content in the slag led to the decrease in surface tension. Surface tension of pure CaO is 0.520 J/m^2 , and of pure Al_2O_3 is 0.720 J/m^2 (Pliner, Y. et al., 1967).

Density of the liquid slag was in the range of $2.7\text{-}2.9 \text{ g/cm}^3$ (for pure Al_2O_3 without CaO the density is 4.0 g/cm^3). Calculations showed that with increase in temperature by 100°C the density decreases by 0.07 g/cm^3 , and it decreases also with increasing of the content of CaO in the slag.

The Energy Dispersive spectrometric (EDS) analysis of the area of the slag (*Fig. 9, Paper I*) showed the presence of carbon, oxygen, aluminium, calcium and niobium in the slag in the following concentrations (*Table 7, Paper I*). The proportion of Ca and Al content corresponded to the proportion of their oxides in the slag with the composition of $3\text{CaO}\cdot 5\text{Al}_2\text{O}_3$. The sample volume was porous with pore diameter of about $20 \text{ }\mu\text{m}$. The sample's phase composition was determined recently in the chemical laboratory of Silmet JSC (Quality Certificate No. 0012870, 2007). According to the quality certificate nr. 0012870 issued by the factory, the content of Al_2O_3 in the slag was 68% and the content of CaO 24%. This composition corresponds to molar ratio of $\text{Al}_2\text{O}_3/\text{CaO} = 1.56$ which is quite close to the theoretical ratio of these oxides (1.67) in the slag of the composition $3\text{CaO}\cdot 5\text{Al}_2\text{O}_3$.

It was also established that in the case of the melting processes according to the reactions [7-10] erosion and destruction of the graphite facing of the furnace took place, and the more, the higher the excess of calcium:



At the stage of higher temperatures the calcium carbide reacts with metallic niobium according to the reaction [12], and „pollutes“ it with niobium carbides:



Niobium carbides (NbC and Nb₂C) are very stable (the melting temperature of NbC is 3480°C), and their removal in the process of remelting is almost impossible.

5.2 Studies and elaboration of the technology for master alloys production

One of the most perspective directions in studies and application of master alloys is elaboration of alloys on the basis of Ni, Co, V and Nb containing the rare earth metals La, Ce, Pr, Nd and Yb (*Paper II*). Master alloys of this type enable to solve the problem of the heat-resistant steel, non-ferrous metals and melts-hydrogen collectors on the basis of LaNi₅ production (Nikonov, 2003).

Studies on the following compositions of rare earth metal (REM) were considered of the first priority: REM-Ni-V-Al-Ca, REM-Ni-Nb-Al-Ca, REM-Ni-Ti-Al-Ca and REM-Fe-Nb-Al-Ca. Production of RE master alloys (REMA) with vanadium or niobium has some significant difficulties due to the several factors (Savitski, 1971; Hansen, 1962). REM are with metallic niobium and vanadium mutually insoluble in the solid as well as in the liquid state up to the high temperatures. For this reason it is very difficult to produce these binary alloys by the „out-of-furnace“ method.

(*Fig.3, Paper II*) characterizes the state diagram of the binary system Nb-Ce (Nikonov et al., 2003). It can be seen that at the temperatures >2370°C Nb and Ce are in the form of two immiscible liquids. At cooling to the lower temperatures a mixture of metal Nb with liquid Ce will be formed, and starting with the temperature of 805°C the melts of Nb with Ce appear.

Master alloys can only be multicomponent, including in their composition melt-forming elements such as nickel and aluminium. Depending on the temperature several compounds of Al and Ce may be formed: CeAl₄, CeAl₂, CeAl and Ce₃Al. Instead of 2370°C here the temperature maximum is ~ 1500°C.

The values of exothermic heat of formation and alumo- and calcithermal reduction reactions of metal oxides (10-12) were calculated according to the Hess Law on the basis of data by (Pliner, 1967) as the differences between of the heat of formation of calcium and aluminium oxides and calcium fluoride, and the reducible oxide, taken in stoichiometric amounts (Table 2) (*Table 1, Paper II*):

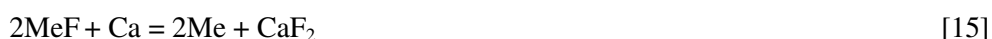

Table 2. The values of exothermic heat of formation and aluminothermal reduction of metal oxides, kJ/mole

Oxides	Melting temperature, °C	Heat of formation	Heat of reduction
Al ₂ O ₃	2044	1117.5	-
CaO	2627	1271.1	+153.6
Nb ₂ O ₅	1510	761.2	-356.3
TiO ₂	1870	945.0	-172.5
NiO	1682	479.8	-637.7
CaF ₂	1418		
CeO ₂	2400	1090.4	
CeF ₃		1962.0	
CeF ₄		1690.3	

The main results of pilot plant and full scale melting tests for REMA production with the mass up to 100 kg per melt are presented in (Table 2, Paper II). In (Table 3, Paper II) the chemical composition of the ingots and eruption of REM, Nb, Ni and Ti into the melt are presented. Data in (Table 3, Paper II) show that the best eruption to the melt proceeds in the case when nickel is included into the mixture of raw materials in the form of NiO. Total mass of the loaded into the pot raw materials reached 160 kg. The main results of the pilot plant and full scale studies were protected by the *Author's Certificates SU* (Primerov et al., 1982, 1984).

Successful pilot plant tests for REMA production with the mass of ingot of 100 kg per melting enabled to scale up the process in a shaft furnace to obtain ingots with the mass of 500 kg per melting at Silmet JSC (Harin et al, 1987) (Paper II). It is interesting fact that there is absolutely no information in literature on the production of REMA ingots with such a high mass. The common mass of the ingots which are produced nowadays in Russia is only 18-50 kg per one melt (Verklov et al., 2003). At the same time specialists of the VNII Khimicheskoi Tehnologii (Moscow) have expressed an opinion that „taking into account the experience obtained at Silmet JSC, it is possible to produce ingots with the mass of 1000 kg per one melt” (Nikonov et al., 2003).

5.3 Computation of the temperature field in the shaft furnace of aluminothermal reduction (Paper III)

Some possibilities of using graphite as a facing material for furnaces in metallurgy, selection of appropriate grade, run of the operation cycle etc. have been studied earlier (Plotnikov et al., 1977). The aim of the present work has

been composing of the mathematical model and computation of the actual temperature field inside of the shaft furnace. This is one of the stages in elaboration of composition of powders and technology of plasma spraying of protective layer onto the furnace graphite facing. Increase in capacity of melting of rare metals and alloys, i.e. increase in intensity of exploitation of the facility are the factors with direct impact on safety of the process. Protective layers on graphite help to solve these safety problems.

Computation of the temperature field in the furnace was accomplished on the basis of real technological parameters of the reduction process. A selection of the appropriate protective layer was carried out and technology of its deposition (spraying) was elaborated. Full scale tests of melting after that enabled to estimate the efficiency of the protective layer.

To elaborate the protective layers for graphite facing it is needed to know the heat distribution and dissipation in the furnace during the aluminothermal melting. For the mathematical model composition and computations several assumptions were made (*Paper III*).

The cooling process of metallic niobium and slag in the furnace can be described by the differential equations of heat conduction (Tihhonov et al., 1972; Jung, 1979). Assuming an ideal contact between the melt and graphite the heat conduction equation for the cross-section of the furnace was written (*Eq.II, Paper III*):

$$\frac{\partial}{\partial x} \left(\lambda \cdot \frac{\partial T}{\partial x} \right) + \frac{\partial}{\partial y} \left(\lambda \cdot \frac{\partial T}{\partial y} \right) = \rho \cdot C \cdot \frac{\partial T}{\partial t} \quad [16]$$

The thermophysical properties (C , λ , ρ) are functions of coordinates and temperature. Their concrete values are determined depending on the given section (layer) of material (metal phase or graphite), where the temperature field is computed.

Phase transfer of liquid metal and slag to the solid state was taken into account by the coefficient of effective heat capacity C_{Eff} . (*Eq. III, Paper III*). After that the boundary conditions on the axis of symmetry of the receiving hopper of the shaft furnace and on the other border of the temperature field were expressed (*Eq. IV and V, Paper III*). Then the coefficients of convective heat transfer and transfer by radiation were included into the system (*Eq. VI and VII, Paper III*).

At initial time moment the melted metal and slag have the temperature T_{in} , but the graphite facing is at the temperature of 20 °C. After that Equation [16] (*Eq. II, Paper III*) with the boundary conditions (*Eq. IV and V, Paper III*) was solved by

the method of finite elements (Seegerlind, 1978). Application of this method requires the variant presentation of the problem. The functional linked to the equation [16] and to the boundary conditions has the following form:

$$T = \int_V \frac{1}{2} \left[\lambda \left(\frac{\partial T}{\partial x} \right)^2 + \lambda \left(\frac{\partial T}{\partial y} \right)^2 + 2 \cdot \rho \cdot C \cdot \frac{\partial T}{\partial t} \right] \cdot dV + \int_S \frac{\alpha}{2} [T^2 - 2 \cdot T \cdot T_0 + T_0^2] \cdot dS \quad [17]$$

In equation [17] the functional of temperature is expressed as a sum of two integrals, the first by volume (dV), and the second by surface (dS).

For solving of the problem the cross section of the furnace and metal receiving hopper were distributed into triangular finite elements. Minimization of the functional [17] for multitude key values leads to the system of common differential equations:

$$[C] \cdot \frac{d\{T\}}{t} + [K] \cdot \{T\} + \{F\} = 0 \quad [18]$$

Applying for approximation of the derivative in time in the central point of the interval

$t_{i+1} - t_i$ an approximate relation:

$$\frac{d\{T\}}{dt} = \frac{\{T\}_{i+1} - \{T\}_i}{\Delta t} \quad (19)$$

a system of linear algebraic equations for the determination of key values of the function at a time moment t_i is obtained:

$$\left([K] + \frac{2}{\Delta t} \cdot [C] \right) \cdot \{T\}_{i+1} = \left(\frac{2}{\Delta t} \cdot [C] - [K] \right) \cdot \{T\}_i - 2 \cdot \{F\} \quad (20)$$

As the value of the temprature in the key points at the initial time moment is unknown, then solving the equation [20] successively for the time moments t_i , where $i = 0, 1, 2, \dots$ etc., it is possible to find the key values of the temperature $\{T\}_{i+1}$. As the thermophysical properties and coefficient of heat transfer depend on temperature, then the matrixes [C], [K] and vector {F} are needed to overcompute at each step of time. Algorithm of the solution of linear algebraic equations was realized in FORTRAN.

Measurements of the temperature of graphite facing and industrial practice have shown that due to its low heat conductivity graphite is not totally heated through or

„baked“, and the process of cooling down of the melt slag-metal is limited by the heat transfer at the interface of melt-graphite. Cover of NbC is by heat conductivity close to graphite and is less sensitive to the thermal stress. The temperature gradient is in transfer from metal to graphite, significantly less than for ZrO₂ (Shalaginov, 1984).

However, when the thickness of covers from NbC and ZrO₂ is in the range of 0.5-1.5 mm, they practically do not have any impact on the structure of the temperature field in the metal receiving hopper. General distinction of all covers - after 12-15 min from the melting starting point the temperature fields despite of their thickness will equalize (Shalaginov, 1984).

Analysis and calculation of the temperature profiles in a shaft furnace of the capacity 500 kg ingots per melting revealed that the area of the highest thermal stress is the „transition part” or belt (Fig. 4) (Fig.2; Paper III). Lines of the isotherms practically match here, especially during the first time moments. The belt undergoes the most intensive erosive destruction and chemical-mechanical impact of the melt.

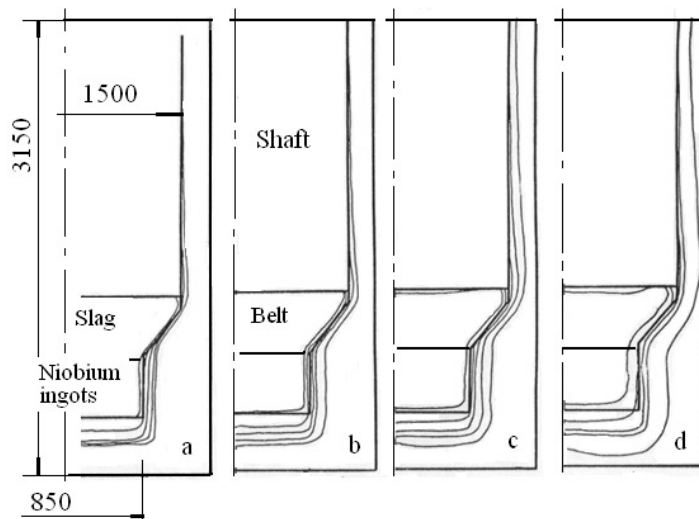

Figure 4. Calculated temperature field of the graphite facing with protective layer of Nb-28NbC. Time after melting: a – 5 s; b – 10 s; c – 30 s; d – 90 s.. Temperature in °C: 50, 500, 1000, 2900.

Established defects in the construction of the furnace with the capacity of 500 kg of ingots were eliminated in the construction of the furnace with the capacity of 2000 kg of ingots per melting (Fig.1.). In Fig.5 the calculated temperature profiles in the wall of this furnace are presented.

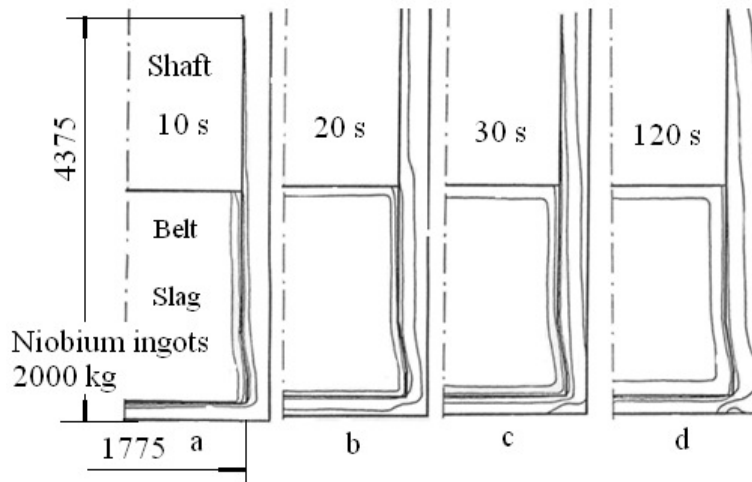

Fig. 5. Temperature profiles of the graphite facing for the furnace with the capacity of 2000 kg of melt ($^{\circ}\text{C}$). Time after melting: (a-b) (10-20 s): 50, 1100, 2000, 2900; (c) (30 s): 50, 300, 1100, 2900; (d) (120 s): 90, 300, 1100, 2000, 2900.

5.4 Protective coatings for the graphite facing in calcium-aluminothermic processes (*Paper IV*)

The main disadvantage of graphite is its increased chemical activity at higher temperatures. Graphite reacts not only with oxygen of air, but also with molten metal as well as with slags (Semchenko, 2005).

Solubility of carbon in liquid aluminium is extremely small, at 800°C it comprises only 0.1% (mass). However, under conditions of the main reduction reaction [10], in the presence of high concentrations of carbon, carbide Al_4C_3 in the form of a slag shell on the spots of the graphite facing with high thermal stress is built up. Similarly, during proceeding of the reduction reaction, at the interface with graphite calcium carbide CaC_2 is formed.

The Gibbs free energy of niobium carbide formation is less than the one of calcium carbide formation. At higher temperatures ($> 2000^{\circ}\text{C}$) the difference in free energies increases (Hasui, 1975). Reduced to the melt liquid niobium actively reacts with calcium carbide forming thermodynamically stable niobium carbide NbC on the surface of graphite facing of the furnace (Eq.12). Metals of the 5th group (V, Nb, Ta) form the carbonaceous compounds much easier than, for example, metals of the

4th group (Ti, Zr, Hf). This can be explained with less free energy of their carbides (MeC) formation as well as with higher diffusivity of carbon in the liquid metals of the 5th group (Kindžeri, 1963).

Protection of graphite with special protective layers enables to prolong its life time and to produce more pure metals and alloys. The best protectors are presumably the high-melting-point oxides, carbides and borides of W, Mo, Nb, Ti, Zr etc. There are only a few examples of production and application of protective coatings for graphite in literature (Kostikov et al., 1978; Kudinov, 1977).

In the present study different coatings (Al_2O_3 , $\text{Al}_2\text{O}_3\cdot\text{CaO}$, ZrO_2 , NbC, $\text{Al}_2\text{O}_3 + \text{Nb}$, $\text{ZrO}_2 + \text{Nb}$, NbC + Nb, Nb) for the shaft furnace were tested. For appropriate coatings elaboration and selection several requirements were established (*Paper IV*).

At the first stage of studies in pilot plant conditions different compositions of coatings (Al_2O_3 , $\text{Al}_2\text{O}_3\cdot\text{CaO}$, ZrO_2 , NbC, $\text{Al}_2\text{O}_3 + \text{Nb}$, $\text{ZrO}_2 + \text{Nb}$, NbC + Nb, Nb) for internal surfaces of graphite pots in the process of reductive meltings with capacity of 10 kg of ingot were tested. The results of tests revealed that all types of coatings, except the metallic niobium, were decomposed after melting more than 50% and were separated from graphite. The reason is that liquid slag in the process of reductive melting reacts actively with oxide type coatings Al_2O_3 and $\text{Al}_2\text{O}_3\cdot\text{CaO}$ (*Fig.1, Paper IV*).

On the coatings from niobium it is possible to follow the effect of selfcompaction due to thermomechanical impact of liquid metal and slag. Metallographically it can be certified by missing of characteristic for plasma coatings porosity and laminated structure. A coating which is in the zone of maximum temperature and under impact of liquid metal and slag, suffers from reduced number of pores due to compaction and add up of some „fresh niobium“ from the melt.

Studies on coatings microstrength indicated that niobium coatings react with graphite facing during the reductive melting. Rate of carbon diffusion into the coating is high, and the coating is during the relatively short melting process quickly carbonized. The curves in (*Fig.3, Paper IV*) indicate that the microstrength increases with approaching to the interface between graphite and coating. It means at the same time that due to niobium carbides formation elasticity of the structure decreases and fragility increases. Application of intermediary layer from niobium aluminide Nb_3Al as a barrier decelerates the process of saturation of niobium coating with carbon significantly. Nb_3Al layer has a strong impact on metallic niobium coating operation properties, prevents carbonization and maintains its plastic properties.

However, this intermediary layer does not promote adhesion with graphite. Repeated thermal cycles of reductive melting weaken adhesion and lead to the

separation of coating from graphite. Pilot tests with niobium coatings of different thickness showed that the thin coatings and the coatings with thickness > 1.1 mm have the highest durability.

Thermal stress created in the conditions of metallothermal melting is responsible for the protective coatings decomposition. Decomposition takes place on the spots of thermal stress concentration - on corners, edges etc. It was established by the author that spraying of intermediary layer from Nb_3Al onto graphite does not improve adhesion of the main protective niobium coating with graphite. Application of relatively thick coatings with intermediary layer from Nb_3Al leads to destruction and separation of coating on the remarkable area of the contact surface (*Fig. 4, Paper IV*).

In practice of metallurgy „liquid glass“ ($R_2O \cdot nSiO_2$) is often used to make the structure of coating more resistant to the thermal shock. This method was also tested by the author in the process of niobium production from its oxide. It was concluded that impregnation with „liquid glass“ significantly reduces degree of carbonization of the main coating and increases its thermal durability. Impregnation with „liquid glass“ leads to the decrease in microstrength and higher elasticity of the structure of niobium coating (*Fig.3, Paper IV*). The coatings of this type were destructed after first melting only 7%.

Elaborated under pilot plant conditions protective coatings were tested in an industrial shaft furnace of Silmet JSC which was described and shown in the publications (*Papers I and III*). The most thermally sensitive graphite surfaces (belt, separation plates of metal receiving hopper) were selected for tests. Technological parameters of coatings plasma spraying were studied in the process of NbAl alloys production with the mass of 500-2000 kg of ingots per melting.

Impact of the three most important parameters of plasma spraying was studied: I - current of arc of plasmatron, A; Q - flow rate of the plasma creating gas (nitrogen), m^3/s and L - distance of spraying, m. For planning of the experiments the method of Box-Wilson and fractional factor's plan 2^{3-1} was used (Adler et al., 1976). Matrix of the plan and results of experiments are given in (*Table 1, Paper IV*). Values of the factors in (*Table 1, Paper IV*) are given in coding system (in brackets are natural values). Adequacy of the model was checked by the Fisher criterion. The model has an adequacy of 5% of significance level. Significance of the coefficients of regression b_i was estimated by the Student criterion building up of reliable interval b_i , corresponding to the 95% of reliable probability.

The regression equation, including the significance of the coefficients in the coding system, is as follows:

$$F = 17.4 - 2.4 \cdot I - 5.2 \cdot Q + 9.4 \cdot L \quad [21]$$

where F - durability of the coatings, %

According to the equation [21] the strongest impact on durability of the coatings has the distance of plasma spraying. Even the smallest changes in distance due to vibration of the plasma spraying gun have the deteriorative impact on the quality of coating on separate places (spots) of the surface. These spots are the primary sources of erosive destruction of coatings on graphite facing (Beketov et al., 1987).

Tests with protective coatings for the belt of the furnace, the second thermally and chemically sensitive zone, revealed that the degree of destruction of protective coating after each melting did not exceed 3-5%. Quite unexpectedly, it was established that the coating on the belt was strengthened after each melting probably due to the positive thermomechanical impact of liquid metal. Application of a three-layer coating graphite – Nb (0.07 mm) – NbC (0.4 mm) - Nb (0.3 mm) gave the best results. After melting about 80% of this coating surface was kept. Due to the protective coatings on graphite the melt of liquid metal was found less carbonized. This fact is very important from the point of view of the ingots quality, as Silmet JSC guarantees the content of carbon in ingots <0.2% (mass) (<http://www.silmet.ee/> 29.10.2007). As a matter of fact, due to the protective coatings on graphite the actual carbon content in metal ingots is 10 times less, ~ 0.02% (mass).

5.5 Utilization of wastes from niobium production

5.5.1 Waste slag from the shaft furnace

The chemical composition and properties of the slags from niobium production was studied to propose some options of their utilization. Composition of the slags can be expressed in the form of oxides - SiO₂, CaO, Al₂O₃ etc. (*Paper I*). In the slag from Silmet JSC niobium production the main chemical compound is 3CaO•5Al₂O₃. The slag can be classified as “high alumina and niobium containing, non-decomposing” slag. Presence of the compound 2CaO•SiO₂ (larnite or calcium orthosilicate) could justify including this slag by physico-technical parameters to the portland cement, as for namely calcium β-orthosilicate is responsible for the cement setting and rock formation (Gorshkov et al., 1966, Hatt et al., 1976).

The transition elements or d-elements (Sc, Ti, V, Cr, Mn, Fe, Co, Ni, Cu and Zn) form complexes easily which may act as catalysts for different reactions and promote crystallization of amorphous phases. This property is often used in cement production. The transition elements in small concentration (i.e activity of the cement), present in the portland cement clinker, guarantee accelerated formation of mineral crystallohydrates.

In the niobium slag from Silmet JSC. the transfer elements are present in remarkable concentrations. These elements do not form separate minerals, but they may be present in the composition of slag’s minerals, replacing some atoms of calcium in crystal

lattice. As a result the solid solutions are formed. In calcium orthosilicate of the cement clinker similar replacement of calcium atoms by the atoms of iron or niobium stabilizes ready to hydration β -form of the orthosilicate.

Due to the specifics of the niobium aluminothermic reduction technology, the slag from it is cooled down without of any control. Cooling proceeds in a slag receiver, after that the slag is transported to the landfill. During the cooling of the slag its surface starts to “boil”, the fountains of the finely dispersed white powder appear. After the temperatures goes down to 100-150 °C the colour of the slag changes to white or to slightly greyish/bluish. It is shown that this slag cannot set in the presence of water, differently from the portland-cement, despite of the fact that both materials contain CaO, but differ in amount of SiO₂.

The slags , which contain calcium aluminates, are considered as a source of valuable raw material for the production of fast-setting and very strong cements. At the present time about 80% of the slags produced in the world are treated and utilized. According to the preliminary tests there are probably the two main options of utilization of the slag from the niobium production. First, a concrete made from 30% of slag and 70% portland cement demonstrated very good building properties. Second, from the above-discussed composition (cement + slag) it also is possible to make another product - “low-grade cement”. This product may be used as a plaster for the construction works. Its waterproofness is higher than that of the portland cement.

The fresh slag with the composition of 3CaO·5Al₂O₃ practically does not react with water. Only after long-time contact with water, approximately a month, part of its grains surface forms hydrated compounds. However the final setting of specimens takes a very long time. Sampling in time from the “slag field” showed that after 5-6 months on the surface of the slag a strong shell (crust) with the thickness of 10-15 cm was formed. This shell was formed as the result of long-term contact of slag with water. The slag beneath the shell was partly decomposed, however its properties of hydration were improved in time.

The softening coefficient (waterproofness) of the specimen, ratio of the strength of the specimen saturated with water to the strength of the dry specimen was 0.9 (for the control specimen from portland cement this parameter was 0.8). Strength of the specimens after 28 days was at least 25 MPa. The crystal hydrates were formed as fast as in the case of cement setting and did not differ from those.

Some options for the sulphate acceleration of the slag hydration (setting) process were studied using the local sulphuric acid wastes from Silmet Ltd. production. The similar technology is applied for the vanadium containing slags having higher content of SiO₂ (Batalin et.al, 1996, 2003). For the niobium containing slags oil shale ash was added as a binder and the construction blocks were formed under pressure of 30 MPa with the following steaming at the atmospheric pressure. The main products were waterproof

(without sintering) “white brick” and concrete blocks of the grade of 150. Without any doubt further systematic studies are required here.

5.5.2 Utilization of deposits from the walls of the shaft furnace (Paper V)

In the „out-of-furnace“ process of niobium pentoxide reduction in a shaft furnace on the graphite facing, in the zone of occurrence of reactions and precipitation of molten products, a layer of deposit is formed as a result of physico-chemical actions between the compounds of the raw mixture, reduced metal and slag with graphite. Interfacial area between the deposit and graphite facing varies in the range of 1.5-2.5 m². Under the conditions where the temperature of the graphite facing at time moment zero is significantly lower (25°C) than the temperature of the molten metal and slag in about 60 s from the starting point of the process, the fast crystallisation reactions proceed on its surface (Plotnikov et al., 1984). The contact surface of the molten metal/slag and graphite is about 3 m².

The thickness of the deposit is typically in the range of 10-80 mm with the total mass > 70 kg. Coefficients of thermal expansion of graphite, slag and metal differ in several orders, and during the cooling process of the products of the melt mechanical tensions (stress) appear at the interface of graphite-metal-slag. At the breaking load a fracture of the most fragile compound, graphite takes place (Fig. 3) (*Fig. 1, Paper V*). Surface of the metal which is in the contact with graphite is covered with this product of the thickness of 5-15 mm, impossible to remove mechanically.

During the preparation of the furnace for the following melting the deposit must be removed. Content of aluminium in the metal is 4.5-5.5% (mass), different admixtures comprise 10⁻¹ – 10⁻²% (mass). Metal is non-homogeneous by chemical and phase composition and has different density through its volume.

For the roentgenphase studies the samples were taken from the different spots of the deposit. Thickness of the deposit was 10-15 mm. Diffractometrical analyses were carried out by layers with the step of 0.5-1 mm. In Fig.6 a diffractogram of the metal side in contact with graphite is shown before and after cleaning with a spray gun. The peaks of niobium carbides (NbC and Nb₂C) are clearly seen. In Fig. 7 the microstructure of the Nb-Al(5%) alloy under SEM is shown.

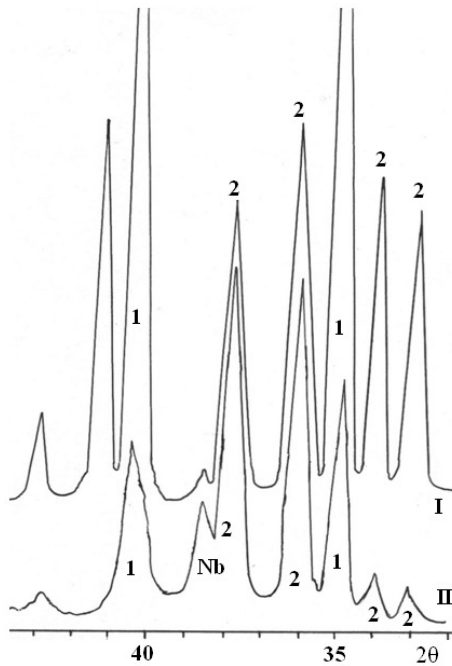

Fig. 6. Diffractogram of metal surface in contact with graphite: 1 – NbC; 2 – Nb₂C. Before treatment with a spray gun (I), after treatment (II).

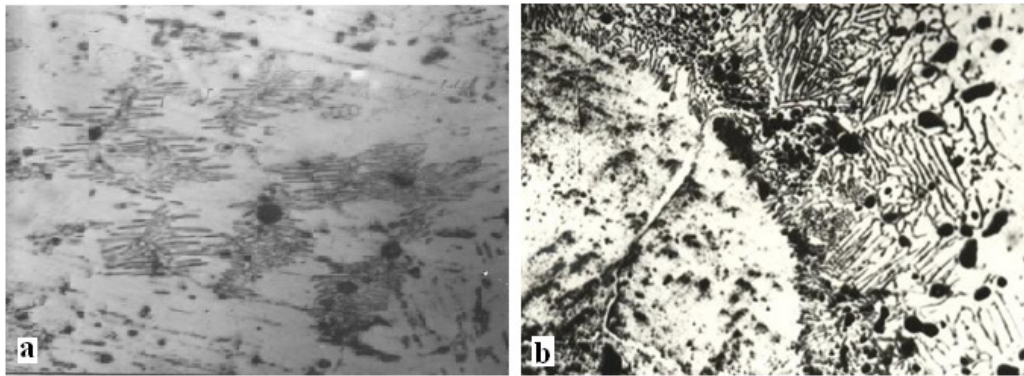

Fig.7. Microstructure of the Nb-Al(5%) alloy: a) before etching, b) after etching. „Fir tree“ like formations are carbide phases.

Deposit is an intermediate product and needs posttreatment for metal separation and utilization of graphite and slag. Statistical data obtained during a year of full scale industrial meltings indicated that at the full scale production up to 2000 kg of ingots losses of niobium with the deposit comprise 1.25-2.84% and may even reach

3.33% (Plotnikov et al., 1984). At the capacity of 384 tons/year of niobium (<http://www.silmet.ee/>) and average price 40 \$/kg the conclusion will be for the benefit of niobium utilization from the deposit.

In 90-ties a method of thermomechanical cleaning of metal from slag and graphite with the following grinding to powder and oxidative burning to niobium pentoxide at the Sillamäe Chemical Factory together with Scientific Research Institute Mehanobr (St. Petersburg) and Scientific Research Institute of Chemical Technology (Moscow) was elaborated and tested at full scale. Several tons of good quality commercial product were obtained. Elaborated technology enables to give up with manual work, to design totally mechanical process and to obtain niobium pentoxide with the stable composition. The results of the pilot and full scale tests are of theoretical and practical interest, and, except a patent (Gorkunov et al., 1986), have not been published earlier.

Grinding of the niobium-aluminium (4-5%) alloy to powder is possible only after preliminary hydrogenation. Hydrogenation reaction proceeds poorly when the surface of metal is covered with mechanical additives (slag, graphite). Heating the deposit up to 800-900°C and applying the effect of thermal deformation simultaneously with mechanical forces it is possible to obtain positive results of metal phase separation from slag and graphite.

To identify slag phase in metal, a careful cleaning of the specimen from graphite and slag was carried out, the specimen was hydrogenated, grinded and the fraction from (-0.1 mm) to (+0.5 mm) was separated. Diffractogram indicated the presence of niobium hydride $NbH_{0.89}$ and calcium aluminates $CaO \cdot 2Al_2O_3$, $3CaO \cdot 5Al_2O_3$ (Fig.8).

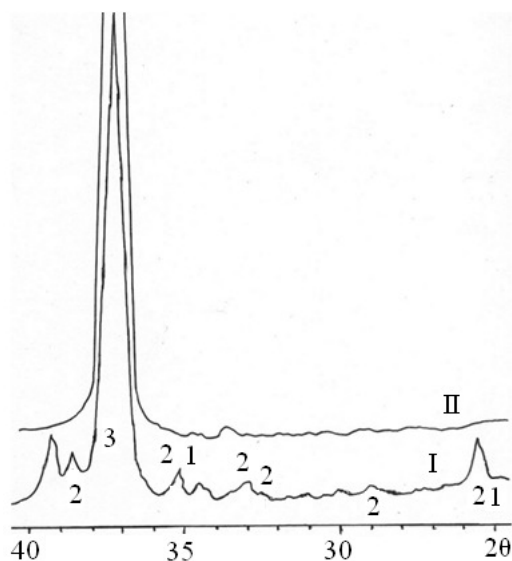

Fig.8. Diffractogram of powdered alloy of Nb-Al(5%): 1 - $3\text{CaO}\cdot 5\text{Al}_2\text{O}_3$; 2 - $\text{CaO}\cdot 2\text{Al}_2\text{O}_3$; 3 - $\text{NbH}_{0.89}$. I – before removal of slag; II – after removal of slag.

Thermal deformation of materials is characterized by the coefficient of thermal expansion (CTE) (Rjabuhhin et al., 1999). Coefficient of linear expansion α - the relative extension of a coupon at the temperature increase by 1°C . Coefficient of volumetric expansion (β) is equal to 3α . These coefficients are valid only below the melting temperature of the material (Askeland, 1994). Niobium and its alloys with aluminium belong to isotropic metals and for them a certain relation between the coefficient of linear expansion α and the melting temperature (T_m) exists (Fig.2, Paper V).

Linear coefficients of thermal expansion α of slag ($3\text{CaO}\cdot 5\text{Al}_2\text{O}_3$) and graphite are close. With increasing of temperature in the interval of $200\text{-}900^\circ\text{C}$ coefficient α of the slag does not change much - it is in the range of $(60\text{-}79)\cdot 10^{-7} \text{ }^\circ\text{C}^{-1}$ (<http://teh-keram.narod.ru/teh.htm>).

Rugged large area of cast metal part of the deposit and slag phase create mutually very good conditions for adhesion. Density of the slag phase ($3\text{CaO}\cdot 5\text{Al}_2\text{O}_3$) is at least 3.7 g/cm^3 . The bending strength of this constraint is 320 MPa (3200 kG/cm^2). Only deformation changes can break it.

Thermomechanical treatment of the deposit was carried out in a rotary kiln in the presence of air (Paper V). Initial lumped material (max. diameter 150 mm) of optional shape underwent treatment at different temperature and time regimes. After unloading the product was mechanically separated to metal and slag phases. The sample of metal was hydrogenated and grinded. In (Table 1, Paper V) the data

on chemical composition of the metal obtained after thermomechanical treatment at 900°C are presented.

At the duration of the process 120 min the slag part of the deposit was enriched with niobium due to oxidation of the open surface of metal and transfer of niobium pentoxide into the slag. Phase analysis of metal indicated presence (in the order of decrease): Nb, Al₂O₃, Nb₃Al. In Fig.9 the dependence of niobium content in the metal phase on temperature of treatment at different duration of the process is shown.

One of the most advanced methods for preparation of powder from niobium ingots is the hydrogenation reaction. As a result a solid solution with the hydrogen content up to 10 atom% containing NbH_{0.7} to NbH is formed. Niobium hydride loses its strength very easily and undergoes grinding to any size. Technology for hydrogenation elaborated for pure niobium (Ljakišev et al., 1988) was adopted with some changes. Retort with alloy was degassed up to the residual pressure of 10⁻¹...10⁻² mm Hg.

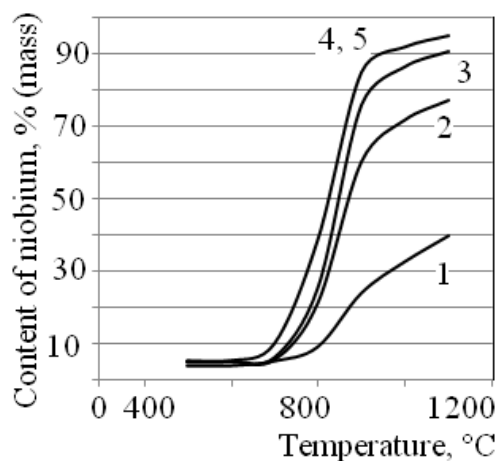

Fig. 9. Content of niobium in the alloy after thermal treatment depending on temperature at different duration (min): 1- 30, 2- 60, 3- 90, 4,5- 120,150.

Saturation of alloy with hydrogen started at 750°C with stepwise reduction of temperature. Total duration of the process was about 20 hrs. Differently from hydrogenation of pure niobium for hydrogenation of alloys extrapure hydrogen and dehydration are not required. The parameters established coincide in general with the recommendations given for technology of hydrogenation of refractory metals (Kolachev, 1985).

The grinding of the hydrogenated alloy Nb-Al was proceeded in a vibrating mill (<http://www.vibrocom.ru/device/mills/mv/mv03.htm>). 80% of the grinding chamber was filled with steel balls of different size, the volume of hydrogenated

alloy comprised the residual 20%. Duration of the process did not exceed 40 min. To prevent oxidation and autoignition of the powder grinding was carried out in the atmosphere of argon (at the pressure of 100 mm Hg). In (*Table 2, Paper V*) the data on granulometric composition of the metal hydride after grinding is presented, and in (*Table 3, Paper V*) the chemical analysis of the powder obtained is given.

It can be seen (*Table 3, Paper V*) that the finest fraction (-0.1 + 0.063) mm has the reduced Nb content and increased content of Al and Ca which can be explained by the „break-through“ of the grinded slag phase. At a very small size of the particles the van der Waals forces of molecular attraction prevail, formation of flocs (aggregates) takes place. Due to abrasion of the steel balls in the mill some addition of iron (0.01-0.03% (mass)) was discovered.

To separate the metal hydride from non-metal phase gravitational enrichment on the concentration table was carried out. In (*Table 4, Paper V*) the chemical composition of the products of gravitational enrichment are given. Content of niobium in the concentrate nr. 1 is 94.5% and in the concentrate nr. 2 93.3%. In the intermediate products is lower content of niobium and significantly higher content of Al and Ca. Photos in (*Fig. 5.1 and 5.2, Paper V*) illustrate the results of enrichment.

To prevent self-ignition (or autoignition) of the powder, the corresponding tests were carried out (*Table 5, Paper V*). At ignition of the fraction (-100 + 63) μm the front of fire spreaded along the surface with the velocity of 0.1-0.2 mm/s, and after that descended into the lower layers. Burning proceeded quietly, with a small flame which at the initial stage was soot-forming (*Fig.6, Paper V*). Derivatographic analysis (*Fig.11*) showed that the metal hydride of the fraction (-100 + 63) μm started to oxidize in the atmosphere of air at 350°C, activation of the reaction started at 480°C. Exothermic effect and maximum gain in mass belong to the temperature of 840°C, endothermal effect, connected with the removal of hydrogen can be followed in the range of temperature 550-700°C. For the powders of higher grain size spread of the flame across the layer was not established.

The fine-grained powder of pure niobium hydride (< 50 μm) is inflammable and explosive, and its concentration in the layer must be less than 3% (mass). Application of inert gas argon keeps the process of oxidation under control, however, formation of the aerosol may cause the safety problems.

5.5.3 Utilization of niobium containing wastes from metallothermal processes

The objects of the studies here were niobium wastes formed in the process of refining remelting of niobium-aluminium alloys in electron-beam furnace. Niobium-aluminium alloys were produced in the process of calcioaluminothermal reduction of niobium pentoxide in a shaft furnace. Content of aluminium in ingots was 4-5% (mass) with impurities of (N, O, C, Ni, Si, Fe, Ca, Ta, W, Mo) in the range of

$10^{-1} \dots 10^{-3} \%$.

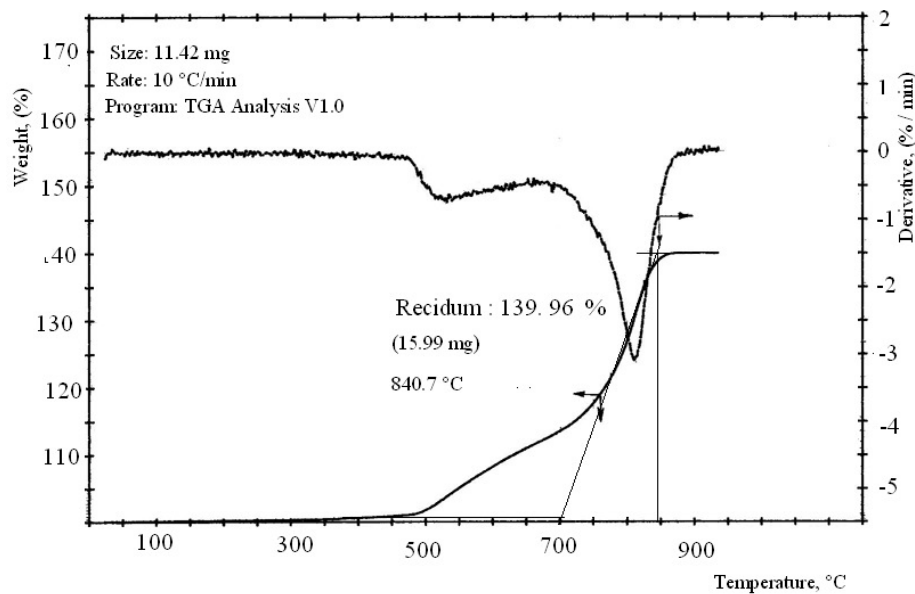

Fig.10. Derivatogram of niobium hydride powder ($-0.1 + 0.063$) mm during oxidation

Technological term for the niobium wastes is „condensed metal” as they were formed as the result of niobium vapours condensation on the inner surface of electron-beam furnace cooled down by cold water.

Chemical composition of condensed metal (niobium) depends on the number of remelting operations. Condensed metal of the first remelting contains up to 36% (mass) of niobium, while in the case of second and third remelting its content is already 75 and 90%, correspondingly. These products of condensed metal are not homogeneous by chemical and phase composition, and they do not present physically a compact or bulk material. Amount of the condensed metal formed in the process of 1-3 remeltings, comprises 3.383; 2.911 and 1.573% from mass of the

remelted ingots. Total yield is 7.867% (V. Plotnikov et al., 1984). Involving about 8% of process losses into the regeneration cycle is justified from the point of view of sustainable technology. Processes of oxidation of niobium were studied in quite detail in 60-70-ties (Kofstad, 1966; Frantševich, 1963). However, these studies were carried out with compact (bulk) materials which are specific. Utilization of non-compact niobium wastes may be implemented in two directions: hydrometallurgical treatment and oxidative combustion. To the first direction the niobium wastes of the first remelting belong and some additional reagents are needed. In the second direction condensed niobium of the 2-3 remeltings is used. Product of the oxidative combustion is mixed with regular commercial niobium pentoxide, obtained from the hydrometallurgical process (Tšumarjov, 2003). The kinetics of the oxidative combustion of the condensed metallic niobium from 1-3 remeltings was investigated in the present study (Table 3). Preliminary treatment included hydrogenation with the following grinding and screening. The process of non-isothermal oxidative combustion was followed on thermogravimeter „Du Pont 1090”, and the isothermal combustion was proceeded in muffle and shaft furnaces at the maximum temperature of 1200°C. Composition of initial and final products was established by chemical and diffraction analyses. The oxidative combustion process of grinded niobium wastes carried the stepped character. It was possible to distinguish the first temperature interval up to 400-450°C for the 1st-2nd remeltings, and up to 200°C for the 3rd remelting. On the surface of the powder of oxidized condensed niobium of the 1st remelting interferencial colours were clearly seen. This is characteristic to the preliminary oxidation period. During this period oxygen dissolves in liquid metal and metal-like oxides NbO_x and NbO_z (suboxides) are formed. Duration of this period is insignificant, and it can be clearly followed only in the case of working with niobium powders. During this period the process is determined by the three parameters: temperature, partial pressure of oxygen and interfacial area of reaction.

Table 3. Chemical composition of condensed metal

Product	Composition, % (mass)						
	Nb	Al ₂ O ₃	Fe ₂ O ₃	SiO ₂	P	C	Ca
First remelting	19.3-35.7	81.0-88.4	2.8-5.9	1.4-2.0	0.3-0.7	0.7-1.0	≤ 0.05
Second remelting	74.3-81.7	8.0-18.2	1.1-3.15	0.6-1.7	0.7-1.6	0.05-0.25	≤ 0.05
Third remelting	85.6-89.5	3.7-8.7	1.18	0.3-0.65	0.65-1.7	0.05-0.2	≤ 0.05

The second stage of the oxidation process is called parabolic. Partial pressure of oxygen is not anymore determining here. For the condensed niobium of the 1st remelting this stage of the process ends at the temperature of 550°C, for condensed niobium of the 2nd remelting at 500°C, and for the metal of the 3rd remelting at 300-350°C (if the fraction is 0.1 mm). At this stage the formation of suboxides NbO_x and NbO_z continues.

Accelerated oxidation and eliberation of heat can be for all specimens of the condensed niobium clearly followed at the stage of destructive oxidation. Graphically this stage has a linear character. For the 1st remelting one decay period and reduction in rate of oxidation takes place, for the 2nd-3rd remeltings two. In Fig.11 the derivatogram of oxidation of condensed niobium from the 3rd remelting is shown.

During the starting period niobium pentoxide is intensively formed with very well developed contact area of powder, and the mass is growing up fast. After that a decay follows due to the decomposition of niobium aluminade NbAl_3 .

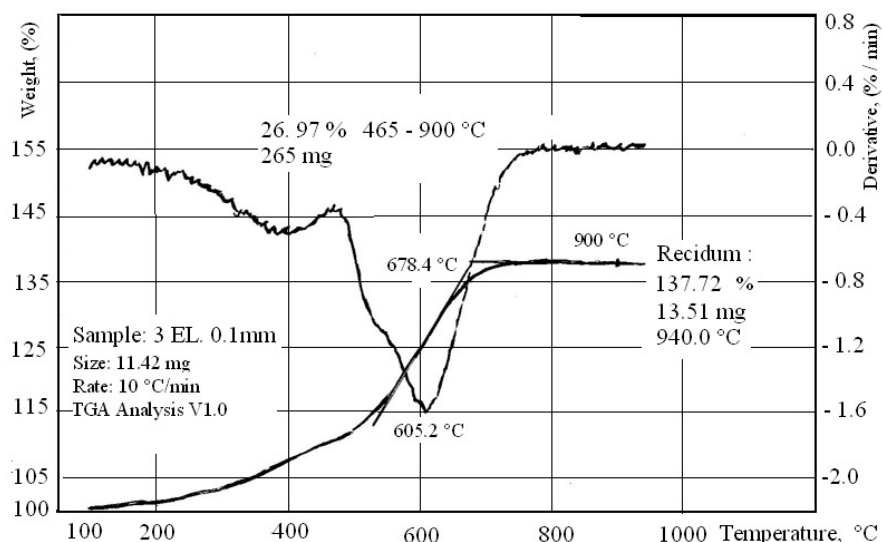

Figure 11. Derivatogram of oxidation of condensed niobium from the 3rd remelting

Results of the diffraction analysis of oxidized condensed niobium from the 1st remelting indicated presence of complex oxide phases $\text{Al}_2\text{O}_3 \cdot \text{Nb}_2\text{O}_5$, $\alpha\text{-Al}_2\text{O}_3$, and very weak lines corresponding to Nb_2O_5 and NbAl_3 . Growth in mass did not exceed 27-30% from the initial. Ultimate oxidation did not happen because the decomposition of NbAl_3 starts at 1660°C (Ljakišev et al., 1988).

Oxidative combustion of condensed niobium from the 2nd and 3rd remeltings led to the better results. Additional heating of the sample up to the permanent

weight (loss in weight at 900°C did not exceed 0.5%) led to the double growth in mass. Diffraction analysis of the product revealed mainly the presence of niobium pentoxide, niobium was missing and NbAl₃ was practically missing.

Technology of „out-of-furnace” reduction of the mixture of Nb₂O₅ (produced from waste) together with Fe₂O₃, Ca and Al for the niobium alloys and master alloys production was elaborated. It was established that the maximum enraption of niobium to the melt (ingot) (98%) can be achieved at the content of Fe₂O₃ in the raw materials mixture of 40% of the mass of niobium pentoxide, and at the 110% excess of the reductant. Optimum composition of the raw mixture (Nb₂O₅ : Fe₂O₃ : Al : Ca) depends on the content of Nb₂O₅ which should not be less than 85%. Chemical composition of the product (niobium alloy) in % is: Nb > 84; Al₂O₃ < 2.0; SiO₂ < 0.7; C < 0.5; P < 0.6 and Fe - the residual.

CONCLUSIONS

The process of niobium pentoxide calcium-alumothermal reduction and niobium alloys production under pilot plant and full scale conditions has been studied and optimized. Methods of utilization for the process wastes have been elaborated.

The process of Nb₂O₅ calcium-alumothermal reduction with the aim of metallic niobium production proceeded in the atmosphere of inert gas Ar in a few minutes (~5-6 min). Differently from the traditional aluminothermal technology here another reducer, metallic calcium was added to the raw materials mixture. The ratio of Ca/Al as well as the reducers excess were optimized to achieve a good separation of slag and metallic phases and a good, “plastic” ingot. It was found that addition of metallic Ca to the raw materials mixture with 10% of excess at the ratio of Ca/Al=0.45 enabled to reduce the Al content in ingot to 4.4%, to increase the Nb content > 90%, and to reduce the residual Nb₂O₅ content in the slag to 2.8-3.0%. Introduction of the results of the pilot plant melting tests into practice led to the excellent parameters of the industrial NbAl-alloys with the mass up to 2000 kg.

Developing technology of metallurgy require to carry out many operations (deoxidation, refining, modification) together with alloying out-of-furnace. Rare earth master alloys (REMA) refine the melt, reduce the size of grains and make the structure of metal ingot more fine. Also the mechanical properties of the metal (electric conductivity, wear and corrosion resistance) are improving. One of the most perspective directions in studies and application of master alloys is elaboration of alloys on the basis of Ni, Co, V and Nb containing the rare earth metals Ce, Pr, Nd, Yb and La. In this work as a basis for REMA technology elaboration the „out-of-furnace“ calcithermal reduction method was taken. Successful laboratory and pilot plant developments in a new technology enabled at

the end of 90-ties to produce at the chemical factory Sillamäe the REMA ingots already with the mass of 500 kg.

During the melting processes the graphite facing of the shaft furnace undergoes high thermal stress as well as mechanical and physico-chemical impact of liquid metal and slag. To elaborate an effective protective layer for the graphite facing of the furnace the studies on the temperature field distribution in the furnace with the capacity of 500 kg of ingots per one melting were carried out. A mathematical model for the temperature distribution calculation in the wall of shaft furnace was composed. The results enabled to discover and to remove several shortcomings in the construction of the furnace. Operation resource of the „transfer part” of the furnace was significantly increased.

To avoid negative processes of the graphite facing destruction, the special plasma sprayed protective coatings are applied. In this study different coatings (Al_2O_3 , $\text{Al}_2\text{O}_3\text{-CaO}$, ZrO_2 , NbC , $\text{Al}_2\text{O}_3 + \text{Nb}$, $\text{ZrO}_2 + \text{Nb}$, $\text{NbC} + \text{Nb}$, Nb) were tested in pilot plant and industrial conditions. It was established that the best durability of protective coating can be achieved in the case of three-layer composition on graphite: Nb (0.07 mm) – NbC (0.4 mm) - Nb (0.3 mm). Results of repeated meltings certified that after each following melting the zones of protective coating destruction did not enlarge more than 3-5%, the coating was strengthened in the melting process and its adhesion with graphite improved as a result of thermomechanical impact of liquid metal. Plasma spraying of protective coatings on graphite facing extended its operation time, reduced the carbon content in metal ingots to 0.02% (mass), and slag carbon content to 0.05-0.15% (mass).

The main waste of niobium production process in the shaft furnace is slag. It was found that under optimum conditions of the reduction process characterized by a good separation of metallic and slag phases and by the minimal content of the residual niobium oxides in the slag, a very good quality, compact and plastic niobium ingot with aluminium content < 5% was achieved. The slag with the dominating composition of $3\text{CaO}\cdot 5\text{Al}_2\text{O}_3$ was formed. The slags, which contain calciumaluminates, can be considered as a possible source of raw material for the production of fast-setting and very strong cements.

Another waste comprise the deposits formed on the walls of the shaft furnace which are composed of niobium, slag and graphite. A combined method of utilization of deposits consisting of the stages of thermomechanical treatment, hydrogenation, grinding and separation was elaborated under industrial conditions. Gravitational enrichment resulted in two concentrates (I - 94.5% of Nb, II – 93.3% of Nb), four intermediate products and two tailings. Aluminium and calcium were concentrated into intermediate products and tailings. The quality of the concentrate I corresponds to the requirements presented to the commercial technical niobium. Altogether more than 20 tons of Nb-Al (5%) powder was produced.

The third type of wastes is so-called „condensed metal” formed in the result of niobium vapours condensation on the inner surface of electron-beam furnace cooled down by cold water. Using the method of thermogravimetric analysis and oxidative combustion in the air, utilization of niobium wastes (condensed metal) from refining remelting of Nb-Al alloys in electron-beam furnace was studied. By diffraction analysis the composition of initial compounds and product of oxidative combustion was determined.

Technology of „out-of-furnace” reduction of the mixture of Nb₂O₅ (produced from waste) together with Fe₂O₃, Ca and Al was elaborated for the niobium alloys and master alloys production. It was established that the maximum enruption of niobium to the melt (ingot) (98%) can be achieved at the content of Fe₂O₃ in the raw materials mixture of 40% of the mass of niobium pentoxide, and at the 110% excess of the reductant. Chemical composition of the product (niobium alloy) in % is: Nb > 84; Al₂O₃ < 2.0; SiO₂ < 0.7; C < 0.5; P < 0.6 and Fe - the residual.

The scientific novelty of the Thesis lies in:

- establishing of the regularities of the reduction reactions of Nb₂O₅ in the presence of the two reducers (Ca, Al) and determination of the physical parameters, chemical and phase composition of the metal (Nb-Al alloy) and slag, depending on the composition of the feed-stock
- determination of the temperature field distribution in a shaft furnace, composing of the corresponding mathematical model, determination of the thermophysical properties of the graphite facing, metal and slag phases and in elaboration of the three-layer protective coating for graphite
- elaboration of the combined method of utilization of niobium-slag-graphite deposits on the shaft furnace walls consisting of the stages of thermomechanical treatment, hydrogenation, grinding and separation.
- elaboration of the combined method of utilization of niobium wastes („condensed niobium”) from the inner surface of electron-beam furnace consisting of the stages of oxidative combustion and „out-of-furnace” reduction of the mixture of Nb₂O₅ (produced from waste) together with Fe₂O₃, Ca and Al, resulting in niobium alloys formation

Practical significance of the Thesis lies in introduction of the results of laboratory and pilot plant studies into the industrial process with the capacities of 500 and 2000 kg of niobium alloy ingots per one melting which has not been achieved by other companies.

REFERENCES

- <http://www.silmet.ee/> 08.07.2007
- <http://www.tanb.org/niobium1.html/> 03.06.2008
- [\(http://nb-niobium.info/production.html/\)](http://nb-niobium.info/production.html/)03.06.2008
- http://www.giredmet.ru/obzory/rare_2006.html/09.10.2006
- [\(http://pubs.usgs.gov/fs/2002/fs087-02/\)](http://pubs.usgs.gov/fs/2002/fs087-02/)31.07.2007
- <http://www.beyondchem.com/rareearth.htm>)/31.10.2007
- <http://www.rosredmet.ru/eng/products.phtml?page=3>)/2.08.2007
- <http://www.tbr.ee/issues/vol20/silmet.html/>31.10.2007
- <http://www.uktd.com.ua/rus/newsmarket/?ld=548>/08.06.2008
- <http://www.mining.kz/index.shtml?show&type=1&id=165999063174>/08.06.08
- <http://www.metaltorg.ru/analytics/publication/index.php?id=2462>)/29.08.2006
- http://www.infomine.ru/otchets/ru_niob.pdf?PHPSESSID=4c84a96bdb32ac4166c6339d5758dd99)/25.07.2008
- <http://www.mineral.ru/Facts/russia/113/110/niobiy.pdf>)/25.07.2008
- <http://news.gorsnab.ru/news/news6508.html>)/25.07.2008
- <http://www.kazatomprom.kz/cgibin/index.cgi?f6&version=ru>)/25.07.2008
- <http://www.metaltorg.ru/analytics/publication/index.php?id=2462>)/25.07.2008
- <http://www.silmet.ee/default.aspx>)/25.07.2008
- Adler, J., Markova, E., Granovski, J.** *Planning of Experiments in Search for Optimum Conditions*. Nauka, Moscow, 1976 (in Russian).
- Arsentjev, P., Yakovlev, V., Krashennikov, L., Pronin, A., Filippov, E.** *Physico-Chemical Methods for Investigation of Metallurgical Processes*. Metallurgiya Publ., Moscow, 1988 (in Russian)
- Askeland, D.R.** *The Science and Engineering of Materials*. Boston: PWS Publishing Company, 1994.
- Batalin B.** Harm and benefits of slags landfills. 2001. *J. Nature*. vol 1. Nr.10, 162-165
- Beketov, A., Bogojavlenski, G., Gorkunov, V.** Elaboration of protective plasma coatings for graphite for reductive meltings of niobium, tantal and rare metal alloys. Report NIR. Ural Technical University, Sverdlovsk, 1987 (in Russian)
- Berg, M., Paršin, A., Plotnikov, V.** Method of metallic niobium production. Patent USSR. Nr. 134623. 1979 (in Russian).
- Bykhovskii, L., Kudrin, V., Usova T.** The value of loparite ores in the mineral/raw materials base and the production of rare metals. In: Proc. of Symposium on Growth of the Rare-Metals Industry in Russia on the Basis of Loparite, St.Petersburg, 2001, pp. 69-75 (in Russian)
- Clark, J., Macquarrie, D.** *Handbook of green chemistry and technology*. UK, Blackwell Publ., 2002. p.434.
- Eljutin, V., Kostikov, V., Lostsov, B.** 1973. *High-temperature Materials*, Metallurgy: Moscow.1973, vol.2, 464 pp.(in Russian)

- Frantševich, I.** High-temperature oxidation of metals and alloys. Kiev, Ukraine, Gostehizdat, 1963. 176-180 (in Russian)
- Gorkunov, V., Tkachenko, I., Primerov, S.** Improvement of the steel EI268L properties. Technology and organisation of production, Kiev, Ukraine, 1986, 1, 29-37 (in Russian).
- Gorkunov, V., Berg, M., Paršin, A.** High temperature processes of removal of slag and graphite from niobium. Author's Certificate SU 233207, 1986 (in Russian).
- Gorshkov V.** Hydration properties of anortite and pseudovollastonite. 1966. J.Appl. Chem., vol 39, Nr.2, 448-451.
- Harin, V., Bražnik, F., Gorkunov, V.** Production of rare earth master alloys. Technological regulation TR.AD.41-56-87. Silmet Ltd.: Sillamäe, Estonia, 1987. 10 pp (in Russian).
- Hasui, A.** Technology of Spraying. Mechanical Engineering, Moscow, 1975 (in Russian).
- Hatt, V., Ners, R.** Phase composition of cement clinker. Theses of the 6th Internat. Congress on Cement. 1976, vol 1, 78-88.
- Jung, H.** The Main Equations and Parameters of Heat Transfer. Handbook. Moscow: Atompublishing, 1979. p.7-41 (in Russian).
- Kindžeri, V.** Measurements at Higher Temperatures. Metallurgizdat, Moscow, 1963 (in Russian).
- Kolachev, B.** Hydrogen fragility of metals. Moscow: Metallurgy, 1985 (in Russian)
- Kofstad, P.** High-temperature oxidation of metal wastes. Central Institute of Industrial Research, 1966, Oslo, Norway, 156 p. (in Russian).
- Kostikov, V., Shesterin, J.** Plasma Sprayed Coatings. Metallurgy, Moscow, 1978 (in Russian)
- Kudinov, V.** Plasma Sprayed Coatings. Nauka, Moscow, 1977 (in Russian).
- Ljakišev, N., Gasik, M.** Theory and technology of ferroalloys production. Moscow, Metallurgy, 1988, 495 p. (in Russian).
- Ljakišev, N.** Aluminothermal processes. Moscow, Metallurgy, 1978, 297-299. (in Russian)
- Lupton, D., Aldinger, F.** Possible substitutes for tantalum in chemical plant handling mineral acids. In: Proc. of the 10th Plansee Seminar, Reutte, Austria, 1981, 1, 101-130
- Nigmatulin, P.** Dynamics of Multiphase Systems. Part I. Moscow. Mir, 1987, 464 p. (in Russian)
- Nikonov, V., Paršin, A., Shatalov, V.** Technological aspects of rare earth master alloys production using metallothermal method. 2003. Casting Industry, vol 7, pp.38-47 (in Russian).
- Okabe, T., Park, Il, Jacob, K., Waseda, Y.** Production of niobium powder by electronically mediated reaction (EMR) using calcium as a reductant. 1999. Journal of Alloys and Compounds, vol 288, 200-210

Pliner, J., Ignatenko, G. Reduction of oxides with aluminium. Moscow, Metallurgy. 1967, p.120-123. (in Russian).

Primerov, S., Gorkunov, V., Harin, V. Master Alloy. *Author's Certif.* SU 1238406 (31.10.1984) (in Russian).

Primerov, S., Plotnikov, V., Verkulov, M. Master Alloy. *Author's Certif.* SU 91082 (07. 03. 1982) (in Russian).

Plotnikov, V., Paršin, A., Gorkunov, V. Elaboration of technology for utilization of niobium wastes. Joint Report. Part I. VNIHT, Moscow, Sillamäe Chemical Factory, Sillamäe, 1984, 36 p. (in Russian).

Plotnikov, V., Zarembo, J., Parshin, A. Studies on aluminothermal production of niobium. Research Report Nr.354-20/03-3. VNIHT, Moscow. 1977. 5-7 (in Russian).

Polyakov, E., Polyakova, L. Current trends in the production of tantalum and niobium. *Metallurgist*, vol.47, Nr. 1-2, 2003 (in Russian).

Press Release. *Natsionalnaya Metallurgiya*, Nr. 2, 5 (2001) (in Russian).

Properties of elements. Handbook. (Ed. Samsonov, S.) Moscow: Metallurgy; 1976. 342 p. (in Russian).

Quality Certificate Nr.0012870. Silmet JSC. 18.05.07.

Raist, P. Aerosols. Introduction into Theory. Moscow, Mir, 1987. 270 p. (in Russian).

Reichert, K. Alternative materials for electrolytic capacitors. *TIC Bull.* Nr. 109, 2-3 (2002)

Rjabuhhin A. Linear coefficient of thermal expansion of metals. In: Physical chemistry and technology of inorganic materials. Proc. of Cheljabinsk Scientific Center, Nr. 3, 1999 (in Russian)

Savitski, V. Rare Earth Metals and Alloys. Science: Moscow: Nauka, 1971, 152 pp (in Russian).

Semchenko, G., Shutejeva, I., Splechenko, O. Protection of Graphite and Graphite Containing Materials from Oxidation. In: *New Refract. Mater.*, 2005, Nr. 7, 25-26, 30-31 (in Russian).

Segerlind, L. Application of the Method of Finite Elements. Moscow: Mir. 1978. 24-71 (in Russian).

Shalaginov, V., Obabkov, N., Gorkunov, V. Elaboration of the composition of protective covers for graphite facing of the shaft furnace by the method of plasma spraying. Research Report Nr. BM-1815. Ural Polytechnical Institute. Sverdlovsk, Russia. 1984. 71 pp.(in Russian).

Sharma, G., Chakraborty, S., Bose D. Preparation of carbon incorporated Nb-Al alloy and its subsequent conversion to pure niobium by electron beam melting. 1996. *Journal of Alloys and Compounds*, vol 236, 216-223

Stallforth, H., Revell, P. *Materials for Medical Engineering.* Wiley-VCH Verlag GmbH, Weinheim, 2000

State Diagrams of Twin Metallic Systems. Handbook. vol.3, Nr.1, 2001, p.706, 737, 806. *Engineering*, Moscow, 2001 (in Russian).

- Stuart, H.** Latest developments in the world of niobium. In: Proc. of International Symposium on Tantalum and Niobium, San Francisco, USA, 2000, pp.121-132.
- Sousa, C., Pereira A.** Recent developments in niobium manufacturing. In: Proc. of International Symposium on Tantalum and Niobium, San Francisco, USA, 2000, pp.133-144.
- Tihhonov, A., Samarski, A.** Equations of Mathematical Physics. Moscow: Nauka, 1972. 22 pp. (in Russian).
- Tšumarjov, V.** Chemistry and kinetics of condensed metal from electron-beam furnace oxidation. *Jekaterinburg, Metals*, Nr.6, 2003, 3-7 (in Russian)
- Ubbelode, A., Lewis, F.** Graphite and its crystallic compounds. Moscow: Mir, 1965. 256 p. (in Russian).
- US Patent 4786319** (<http://www.freepatentsonline.com/4786319.html>/31.10. 2007
- Verklov, M., Zots, N., Vassiljev, V.** Production of silicon free rare earth master alloys based on nickel and iron. Proc. of the Conference „Casting Industry Today and Tomorrow”.14.04-17.04.2003, St.Petersburg. Russia. 2003, 203, 27-29 (in Russian).
- Verklov, M., Vassiljev A., Zots, N.** Production of silicon-free modifiers. Russian patent Nr. 2181784 (2001)
- Volskii, A., Sergijevskaja, E.** Theory of metallurgy. Moscow, Metallurgy, 1968 (in Russian).
- Zelikman, A., Koršunov, B., Eljutin, A.** Niobium and tantalum. Moscow, Metallurgy, 1990. pp.120-125 (in Russian).

ABSTRACT

Calcium-aluminothermal Production of Niobium and Utilization of Wastes

The present Thesis was aimed at studying and optimization of niobium pentoxide calcium-aluminothermal reduction and niobium-aluminium alloys (including REM alloys) production. Methods of utilization for three types of the process wastes (slag from the shaft furnace and deposits from its walls, condensed niobium from the inner walls of the electron-beam furnace) have been elaborated and tested in pilot and full scale.

The main parameters of the „out-of-furnace“ process of niobium pentoxide reduction (raw materials mixture composition, ratio of reducers Ca/Al and reducers excess) have been optimized to achieve a good separation of slag and metallic phases and to obtain a good, „plastic“ ingot with Nb content > 90% and Al content < 4.5% with the residual Nb₂O₅ content in the slag to 2.8-3.0%.

„Out-of-furnace“ technology for niobium REM alloys, containing rare earth metal (Ce, La, Pr et al.) Nb, Fe, Ni, Ti, Al, Ca, production in full scale (500 kg per melting) has been elaborated.

Resistance of the shaft furnace graphite facing to thermal, chemical and mechanical stress has been studied in detail. A mathematical model for the temperature distribution calculation in the wall of the shaft furnace has been composed and the composition of a three-layer protective coating (Nb (0.07 mm) – NbC (0.4 mm) - Nb (0.3 mm) elaborated and tested in full scale. As a result the carbon content in metal ingots was reduced to 0.02% (mass) and in slag to 0.05-0.15% (mass).

Technology for the process wastes utilization has been elaborated. The slag from shaft furnace containing calciumaluminates can be considered as a possible source of raw material for the production of fast-setting and very strong cements. Deposits from the shaft furnace inner walls containing niobium, graphite and slag can be utilized using thermomechanical treatment, hydrogenation, grinding and mechanical separation. From the condensed niobium wastes of electron-beam furnace niobium pentoxide can be produced which together with Fe₂O₃, Ca and Al forms a niobium alloy with the composition of (in %): Nb > 84; Al₂O₃ < 2.0; SiO₂ < 0.7; C < 0.5; P < 0.6 and Fe - the residual.

KOKKUVÕTE

Niobiumi tootmine kaltsium-alumotermilisel meetodil ja jäätmete utiliseerimine

Käesoleva dissertatsiooni eesmärgiks oli niobium pentoksiidi kaltsium-alumotermilise taandamisprotsessi uurimine ning optimeerimine niobium-alumiinium sulamite ning niobiumi ja haruldaste muldmetallide sulamite tootmiseks tööstuslikus mastaabis. Töötati välja kolme liiki tootmisjäätmete (šahtahju šlakk, ahju siseseintele sadestunud niobiumi-grafiidi-šlaki segu, niobiumi sulami rafineerimise elektronkiirgusahju siseseintele kondenseerunud niobium) utiliseerimise tehnoloogia, mida katsetati pilootseadmél ja tööstuslikes tingimustes.

Optimeeriti niobium pentoksiidi taandamise „out-of-furnace“ protsessi põhilisi parameetreid (toorsegu koostis, taandajate Ca/Al suhe ning taandajate liig), et saada hea kvaliteediga, „plastilist“ sulamit, milles Nb sisaldus on > 90%, Al sisaldus < 4.5% ning Nb₂O₅ jääksisaldus šlakis kuni 2.8-3.0%.

Töötati välja ka Nb, Fe, Ni, Ti, Al, Ca ja haruldaste muldmetallide (Ce,La,Pr jt.) sulamite tootmise „out-of-furnace“ protsess tööstuslikus mastaabis (kuni 500 kg ühe sulatusprotsessi kohta).

Uuriti detailselt šahtahju grafiitvooderdise termilist, keemilist ja mehaanilist vastupidavust kõrgetel temperatuuridel. Koostati matemaatiline mudel, mis võimaldab arvutada temperatuuride jaotust ahju seinas. Selle töö tulemusena katsetati erinevaid grafiidi kaitsekihi koostisi ning töötati välja kolmekihiline kaitsekiht koostisega Nb (0.07 mm) – NbC (0.4 mm) - Nb (0.3 mm). Selle kaitsekihi katsetamisel vähenes süsiniku sisaldus sulamis kuni 0,02%-ni (mass) ja šlakis kuni 0,05-0,15 % (mass).

Töötati välja tootmisjääkide utiliseerimise tehnoloogia. Leiti, et šahtahju šlakk on kasutatav toorainena tugevate ja kiirelt tarduvate tsementide ning betoonide tootmisel. Šahtahju seinetele sadestunud jääke, mis koosnevad niobiumist, šlakist ja grafiidist, saab utiliseerida, kasutades termomehaanilist töötlemist, hüdrogeenimist, jahvatust ning mehaanilist separatsiooni. Elektronkiirgusahjude jääkidest (kondenseerunud niobium) on võimalik toota niobium pentoksiidi ning koos Fe₂O₃, Ca ja Al-ga niobiumi sulameid koostisega (%-des): Nb > 84; Al₂O₃ < 2.0; SiO₂ < 0.7; C < 0.5; P < 0.6 and Fe – ülejäänud.

APPENDIX A

APPENDIX B

ELULOOKIRJELDUS

1. Isikuandmed

Ees-ja perekonnanimi: **Valeri Gorkunov**

Sünniaeg ja -koht: 02.01.1947, Stavropoli krai, Nevinnomiski linn

Kodakondsus: puudub

2. Kontaktandmed

Aadress: Gagarini 27-17, Sillamäe 40233, Ida-Virumaa, Eesti

Telefon: (+372) 39-72215

E-posti aadress: valerig47@mail.ru

3. Hariduskäik

Õppeasutus (nimetus lõpetamise ajal)	Lõpetamise aeg	Haridus (eriala/kraad)
Uurali Polütehniline Instituut	1978	Insener-tehnoloog (haruldaste metallide tehnoloogia)
34. Keskkool, Groznõi, Tšetšeenia	1965	Keskkool

4. Keelteoskus (alg-, kesk- või kõrgtase)

Keel	Tase
Eesti keel	Algtase
Vene keel	Kõrgtase
Inglise keel	Keskstase

5. Täiendusõpe

Õppimise aeg	Täiendusõppe läbiviija nimetus ja kursus
1985-1988	Moskva Keemilise Tehnoloogia Instituudi aspirant
1999	Tartu Ülikooli pedagoogika-alane koolitus õpetajatele
2002	Tartu Ülikooli tehnikavaldkonna õpetajate õppekava
2003	TTÜ, õpetaja kutse keemia-ja materjalitehnoloogias

6. Teenistuskäik

Töötamise aeg	Tööandja nimetus	Ametikoht
1978-1990	Sillamäe tehas	Insener-tehnoloog
1990 -1992	Tehas KVO (Ivangorod)	Tsehhiülem 1992

1992-.....

Narva Kutseõppe Keskus

Õpetaja

7. Kaitstud lõputööd

Keemiainseneri diplomtöö: Kuumpressimine ja karbiid-süsinik kompositsioonmaterjalide struktuur. Uurali Polütehniline Instituut, 1978.

Juhendajad:

Tehnikadoktor V.Vlassov ja tehnikakandidaat A.Beketov

8. Autasud

1989 - Riiklik Hõbemedal nikli baasil haruldaste muldmetallide ligatuuride tootmise tehnoloogia väljatöötamise eest (Autoritunnistus Nr. 1238406)

CURRICULUM VITAE

1. Personal data

Name: **Valeri Gorkunov**

Date and place of birth: 01.02.1947, Stavropol county, city Nevinnomisk

Citizenship: Stateless

2. Contact information

Address: Gagarini 27-17, Sillamäe 40233, Ida-Virumaa, Estonia

Phone: (+372) 39-72215

E-mail: valerig47@mail.ru

3. Education

Educational institution of study	Graduation year	Education (field (degree)
Ural Polytechic Institute	1978	Engineer-technologist
34th High School, Grozny, Chechny	1965	High School education

4. Language competence/skills (fluent, average, basic skills)

Language	Level
Estonian	Basic
Russian	Fluent
English	Average

5. Special courses

Period	Educational or other organisation
1985-1988	Ph.D. student in Moscow Institute of Chemical Technology
1999	Pedagogical courses for teachers at Tartu University
2002	Tartu University's curriculum of teachers of technical subjects
2003	Tartu University's teacher's diploma in chemical technology

6. Professional employment

Period	Organisation	Position
1978-1990	Sillamäe factory	Engineer-technologist
1990 -1992	Factory KVO (Ivangorod)	Head of workshop
1992 -	Narva Center of Professional Studies	Teacher

7. Defended theses

Chemical Engineer`s Diploma: Hot pressing and carbide-carbon composition materials structure. Ural Polytechnic Institute, 1978.
Supervisors: D.Sc. V.Vlassov;

Cand. Sci. A.Beketov

8. Awards

1989 - National Silver Medal for elaboration of technology for production of rare earth metals` master alloys on the basis of nickel (Authors Certif. Nr. 1238406)