



TALLINNA TEHNIKAÜLIKOOL
TALLINN UNIVERSITY OF TECHNOLOGY

Department of Materials and Environmental Technologies

AUTOMATIC DUST COVER DETECTION IN PHOTOVOLTAIC MODULES

Päikesepaneelide puhtuse automaatne monitoorimine

MASTER THESIS

Student: Olexander Dolgykh

Student code: 146673KAYM

Supervisor: Andri Jagomägi, Ph.D., Research Scientist

Tallinn, 2018

AUTHOR'S DECLARATION

Hereby I declare, that I have written this thesis independently.

No academic degree has been applied for based on this material. All works, major viewpoints and data of the other authors used in this thesis have been referenced.

"....." 2018

Author:

/signature /

Thesis is in accordance with terms and requirements

"....." 2018

Supervisor:

/signature/

Accepted for defence

"....."2018

Chairman of theses defence commission:

/name and signature/



TALLINNA TEHNIKAÜLIKOOL
INSENERITEADUSKOND

Materjali ja keskkonnatehnoloogia instituut

PÄIKESEPANEELIDE PUHTUSE AUTOMAATNE MONITTOORIMINE

Automatic dust cover detection in photovoltaic modules

MAGISTRITÖÖ

Üliõpilane: Olexander Dolgykh

Üliõpilaskood: 146673KAYM

Juhendaja: Andri Jagomägi, Ph.D., Teadur

Tallinn, 2018

AUTORIDEKLARATSIOON

Olen koostanud lõputöö iseseisvalt.

Lõputöö alusel ei ole varem kutse- või teaduskraadi või inseneridiplomit taotletud. Kõik töö koostamisel kasutatud teiste autorite tööd, olulised seisukohad, kirjandusallikatest ja mujalt pärinevad andmed on viidatud.

“.....” 2018

Autor:

/ allkiri /

Töö vastab bakalaureusetöö/magistritööle esitatud nõuetele

“.....” 2018

Juhendaja:

/ allkiri /

Kaitsmisele lubatud

“.....”2018

Kaitsmiskomisjoni esimees

/ nimi ja allkiri /

THESIS TASK

Student Olexander Dolgykh, 146673KAYM
Study programme: Materials and Processes of Sustainable Energetics
Supervisor(s): Andri Jagomägi, Ph.D., Research Scientist

Thesis topic:

(in English) AUTOMATIC DUST COVER DETECTION IN PHOTOVOLTAIC MODULES

(in Estonian) PÄIKESEPANEELIDE PUHTUSE AUTOMAATNE MONITOORIMINE

Thesis main objectives:

1. Design technology for dust sensing
2. Manufacturing module prototypes
3. Testing the sensitivity of dust detection system
4. Finding ways for performance improvement of detection system

Thesis tasks and time schedule:

No	Task description	Deadline
1.	Planning and designing dust detection system	5.03.18
2.	Proof of concept	5.04.18
3.	Testing and finding flaws in design	5.05.18

Language: English **Deadline for submission of thesis:** 30 May 2018

Student: Olexander Dolgykh

Supervisor: Andri Jagomägi

CONTENTS

PREFACE.....	5
LIST OF ABBREVIATIONS AND ACRONYMS.....	6
INTRODUCTION	8
1 REVIEW.....	9
1.1 Basic solar electricity generating technologies	9
1.2 Photovoltaic technology overview	10
1.3 Electrical characteristics	13
1.4 PV performance.....	15
2 PRACTICAL PART.....	20
2.1 Experiment overview.....	20
2.2 Small-scale test.....	21
2.3 Full-scale test.....	22
2.4 LED distance test.....	29
2.5 Dust detection and losses.....	33
3 CONCLUSIONS	36
4 PROBLEMS TO SOLVE.....	37
5 FUTURE PLANS AND DEVELOPMENT.....	39
SUMMARY	42
LIST OF REFERENCES.....	43

PREFACE

This research was initiated by Andri Jagomägi and Roofit Solar Energy OÜ. Experimental part was performed at Roofit Solar Energy OÜ production site. All equipment and resources were also provided by Roofit Solar Energy OÜ.

I would like to express my deep gratitude to my supervisor Andri Jagomägi, my brother, all friends and colleagues who provided their aid during this research.

I would like to say “Thank You” to everyone from Department of Materials and Environmental Technologies.

LIST OF ABBREVIATIONS AND ACRONYMS

LED	light-emitting diode
NOCT	Normal operating cell temperature
ICT	Insulated cell temperature
PV	Photovoltaic
TF	Thin film
CAGR	Compound annual growth rate
STC	Standard test conditions
IR	Infra-red

LIST OF SYMBOLS

Symbol	Description (value)	Units
k_B	Boltzmann constant	
T	Absolute temperature	C
q	Electron charge	K
V	Voltage at the contacts of the cell	V
I_{ph}	Photo-generated current	A
I_o	Diode saturation current	A
I_{sc}	Short-circuit current	A
V_{oc}	Open-circuit voltage	V
I_m	Current at maximum power point	A
V_m	Voltage at maximum power point	V
P_{max}	Maximum power	W
FF	Fill factor	
I_{amb}	Short circuit current of pv panel under ambient light	A
I_{ambLED}	Short-circuit current of pv panel under ambient and led light	A
I_{LED}	Short circuit current of pv panel under led light	A
I_{lamp}	Short circuit current of pv panel under halogen lamp light	A
I_{clean}	Short circuit current of clean pv panel	A
$I_{dust1...3}$	Short circuit current of pv panel with 1...3 layer of dust	A
V_r	Reference signal voltage	V
V_s	Input signal voltage	V

INTRODUCTION

Due to growing demand on electric power and increasing price of fossil fuels alongside with environmental regulations for CO₂ emission the renewable energy sources became a topic of high importance. Wind, solar, water and other forms of renewable energy are more and more showing up in our lives. New sustainable technologies, smart grids, smart houses, electro mobiles and many others are appearing throughout the world every year with goal to fulfill the demand and improve everyday life.

Today one of the most important and convenient ways to produce sustainable energy is photovoltaic (PV). Sun is the most powerful energy source in whole solar system. Harnessing this free energy is a good idea in order to save valuable materials such as oil, gas and other fossils that humans use for hundreds years as main power source to fulfill their needs. Solar panels appeared back in 50s and used mainly in space industry for powering satellites. Technologies developed and solar panels started to appear in industrial use for powering remote locations and soon became more and more procurable for domestic use. Since late 90s utilization of PVs grew rapidly, with around 30% year increase of installed capacity with estimated market capacity for 2016 at 239.93 GW, which will reach 489.79 GW by 2020 [1]. You can see roofs of buildings more and more often covered with solar panels. New technologies allow us to integrate PV elements in windows, cars, cell phones. Pretty much every technological device can be equipped with its own power source to increase its autonomy from the grid and reduce ecological footprint.

Today market can provide a variety of different PV module types with different technologies, manufacturing techniques and variety of form factors to suit pretty much any application. Each technology has its own pros and cons. The main factors that stipulate the performance of any solar panel are environmental factors. Amount of sun irradiation, day length, temperature, module orientation to the sun, rain, snow, dust, all these factors affect module's performance.

The goal of this study is to create a system that will help detecting dust and dirt layer on PV panel (or any other similar device) in order to provide cleaning in time to get better efficiency and prevent losses.

1. REVIEW

1.1 Basic solar electricity generating technologies

There are two main concepts of power generation from solar energy: thermal and photovoltaic. [2]

Thermal technology is close to convenient power plants, but instead of burning coal, gas or oil it uses mirrors that focus sunlight on a tank with salt or tube of water. These concentrated sunrays create a huge amount of heat energy which is converted into mechanical energy of steam that runs steam turbine to generate electricity. Mirrors may have different shapes: parabolic troughs, dishes or multiple flat mirrors (Linear Fresnel reflectors) targeted the way to concentrate sunlight into one point above them. [3].

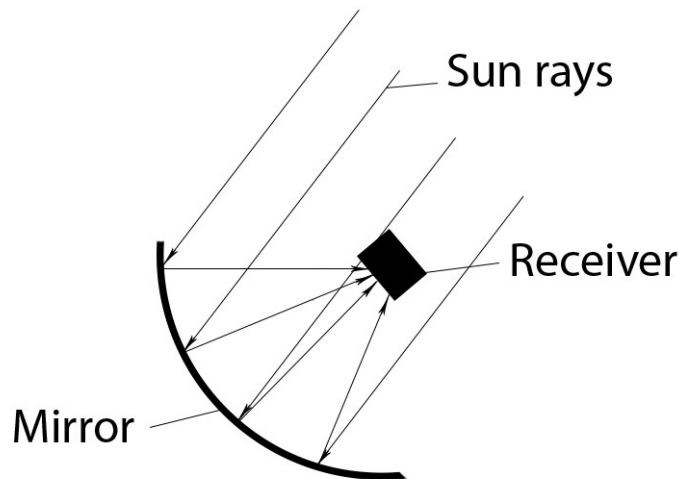

Figure 1.1. Schematic of thermal solar dish

Photovoltaics use a completely different approach. Unlike thermal solar energy, PV does not use kinetic energy, it convert energy of light into electricity directly. It uses semiconductors to produce electrical energy. Photons absorbed by PV cell force electrons of material's atoms to move and create electrical current. PV cell's electrical characteristics (voltage, current, resistance) are dependent from light intensity and temperature. Modern cells are quite sensitive and due to this they found application as light sensors also.

In this particular research we will be concentrating on PV technology, but dust detection system could be applicable for thermal solar stations too, in some extent.

1.2 Photovoltaic technology overview

As for any technology there are pros and cons.

Benefits of PV:

1. It is a clean energy source. It does not generate CO₂ gasses, smoke and ash. Does not pollute surrounding air and water. Does not emit carcinogen material that are harmful not only for humans but for nature around. PV uses only sunlight, not fossils and other valuable natural resources to generate electricity.
2. Can supply with electricity even most remote places in the world. Good choice for countries without good energy resource base.
3. Provides independence in energetics field for developing countries. Reduces footprint for energy resource transportation.
4. Versatile. Can be configured for any consumer with any amount of power consumption. Can be applied for domestic use or commercial power generation. Can be used with mobile devices, vehicles, spacecrafts etc.
5. Silent. Do not pollute surroundings with noise. Can be mounted on top of living buildings.
6. Can be mounted in heavily industrialized places on roof tops of buildings. Do not require territory dedicated only for PVs. [8, 9]

Disadvantages of PV:

1. Some PV cells use highly toxic materials for their production, like As and Cd. Requires strict manufacturing control, recycling and disposal process in order to prevent environmental pollution.
2. High manufacturing cost. Though generation is free but technology is still developing and prices on market are pretty high compared to conventional power generation.
3. Efficiency is much lower than traditional fossil or nuclear generation.
4. Does not provide constant energy output, because it is relying on many factors, like amount of sunlight, temperature, weather conditions etc. Amount of annual solar irradiation varies on location where PVs are installed. [8, 9]

There are multiple types of PV cells, mainly they are classified as generations: first, second and third. First generation is the most used technology made of silicon wafer. First generation cells

can be based on monocrystalline silicon wafer or polycrystalline. Such cells are cut from single crystal of silicone or from silicon ingot that was melted and recrystallized. Monocrystalline silicone panels are the most efficient ones at the market today. Second generation cells are based on thin film (TF) technology. They use CdTe, CIGS and amorphous silicon. These cells require less material and are faster to produce. This results in cheaper price to produce than traditional silicon cells, but they are a bit less efficient. Third generation also use TF technology and many of them are based on organic materials. Third generation is still in a research form and does not have commercial application yet. [4]

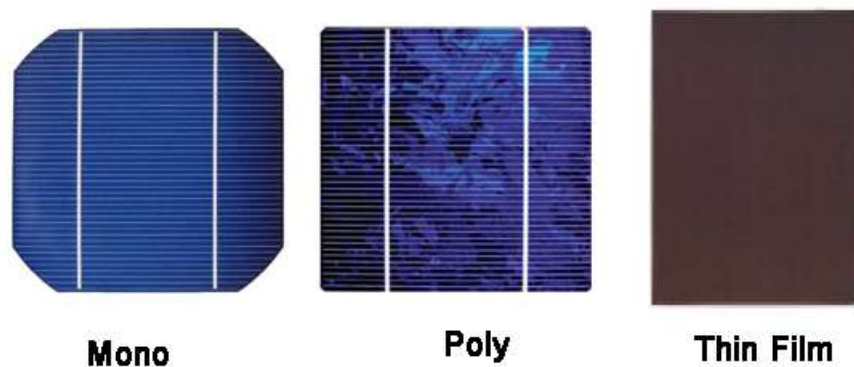

Figure 1.2. Mono, poly-crystalline and TF cells [21]

Market of PVs is growing very fast. More and more people are interested in sustainable energy, new manufacturers appear each year with new technologies and designs. More and more money are funded for researches in field of PV. New regulations and new energy tariffs provided by governments contribute to the popularization and market growth. In period from 2010 to 2016 Compound Annual Growth Rate (CAGR) of PVs was around 40%. China and Taiwan with share of 68% were main manufacturers of solar panels by 2016. 14% of the share belong to the rest of Asian region. Followed by North America (USA, Canada) with 6% and Europe with 4%. Mono and poly-crystalline silicone modules took around 24% and 70% of total production in 2016 respectively. 6% of production belong to TF technology. [10]

Table 1. PV module efficiencies (measured under 1000 W/m²; 25 °C) [5]

PV cell type	Efficiency, %
Si (crystalline)	24.4±0.5
Si (polycrystalline)	19.9±0.4
GaAs (TF)	24.1±1.0
CdTe (TF)	18.6±0.6
CIGS (TF, Cd free)	17.5±0.5

For energy generation any light source is good. Light's photons that are absorbed by PV cell generate electricity. Some of the light is been reflected, some pass through the cell. Surface of the cell is made the way to increase the amount of absorbed photons as well as amount of free or dislodged electrons. [3] PV cells are usually thin and quite brittle and are covered by glass or other transparent coating, which protects cell from dust, hail and other impacts. Usually this coating has textured surface to reduce reflection.

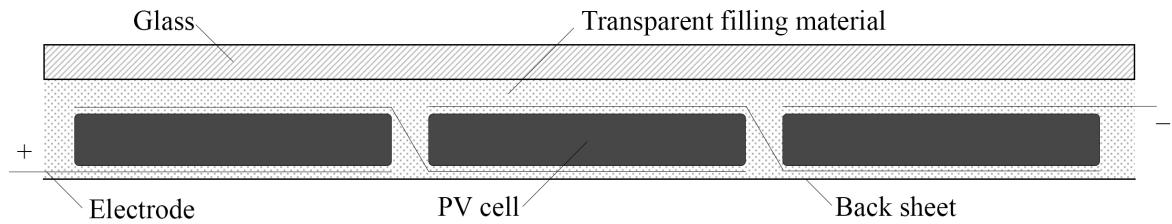

Figure 1.3. PV module schematic

In this study we will mostly concentrate on mono and poly-crystalline modules as it's a typical solar cell used nowadays.

Body of crystalline cell is made of p-type base which absorbs pretty much all of the falling light, diffusing electrons to the p-n junction. Electrons are collected by metal electrodes located in front and back of the cell. [6] Figure 1.3 shows basic schematic of PV module produced. Multiple cells are connected together to form lines in order to increase total power of a solar module. Back sheet of module can be made from different materials depending on purpose and mounting method of the module, or like in our testing example have no back sheet at all. Structural integrity of each module is provided by a special filler material, in our case it was Polyolefin. During thermal treatment Polyolefin is molded into a shape of the module, it provides thermal and electrical

insulation, protects brittle cells from mechanical impacts during manufacturing, transportation and installation processes. [7] Filling material should be transparent to allow light to pass to the cell.

1.3 Electrical characteristics

Main characteristics of any PV cell are current and voltage.

Shockley solar cell equation is used to describe I - V characteristic of PV cell. [6]

Output current of a cell:

$$I = I_{ph} - I_0 \left(\frac{qV}{e^{k_B T} - 1} \right); \quad (1.1)$$

Where k_B – Boltzmann constant,

T – absolute temperature,

q – electron charge,

V – voltage at the contacts of the cell,

I_{ph} – photo-generated current,

I_0 – diode saturation current.

Short-circuit current for ideal PV cell, I_{sc} :

$$I_{sc} = I_{ph}; \quad (1.2)$$

Open-circuit voltage, V_{oc} [6]:

$$V_{oc} = \frac{k_B T}{q} \ln \left(1 + \frac{I_{ph}}{I_0} \right); \quad (1.3)$$

Figure 1.4 (A) shows relation between voltage, current and power of ideal PV cell. P_{max} – maximum power generated by an ideal cell. I_m and V_m – current and voltage at maximum power point. To determine the overall quality and performance of PV fill factor (FF) is used. FF represents the available power at P_{max} divided by V_{oc} and I_{sc} [11]:

$$FF = \frac{I_m V_m}{I_{sc} V_{oc}} = \frac{P_{max}}{I_{sc} V_{oc}}; \quad (1.4)$$

Figure 1.4 (B) shows graphical FF comparison of two PV cells. From equation (4), areas A_1 and A_2 are maximum powers of real and ideal cells respectively, area B is I_{sc} multiplied by V_{oc} [12]:

$$FF = \frac{P_{max}}{I_{sc}V_{oc}} = \frac{areaA}{areaB}; \quad (1.5)$$

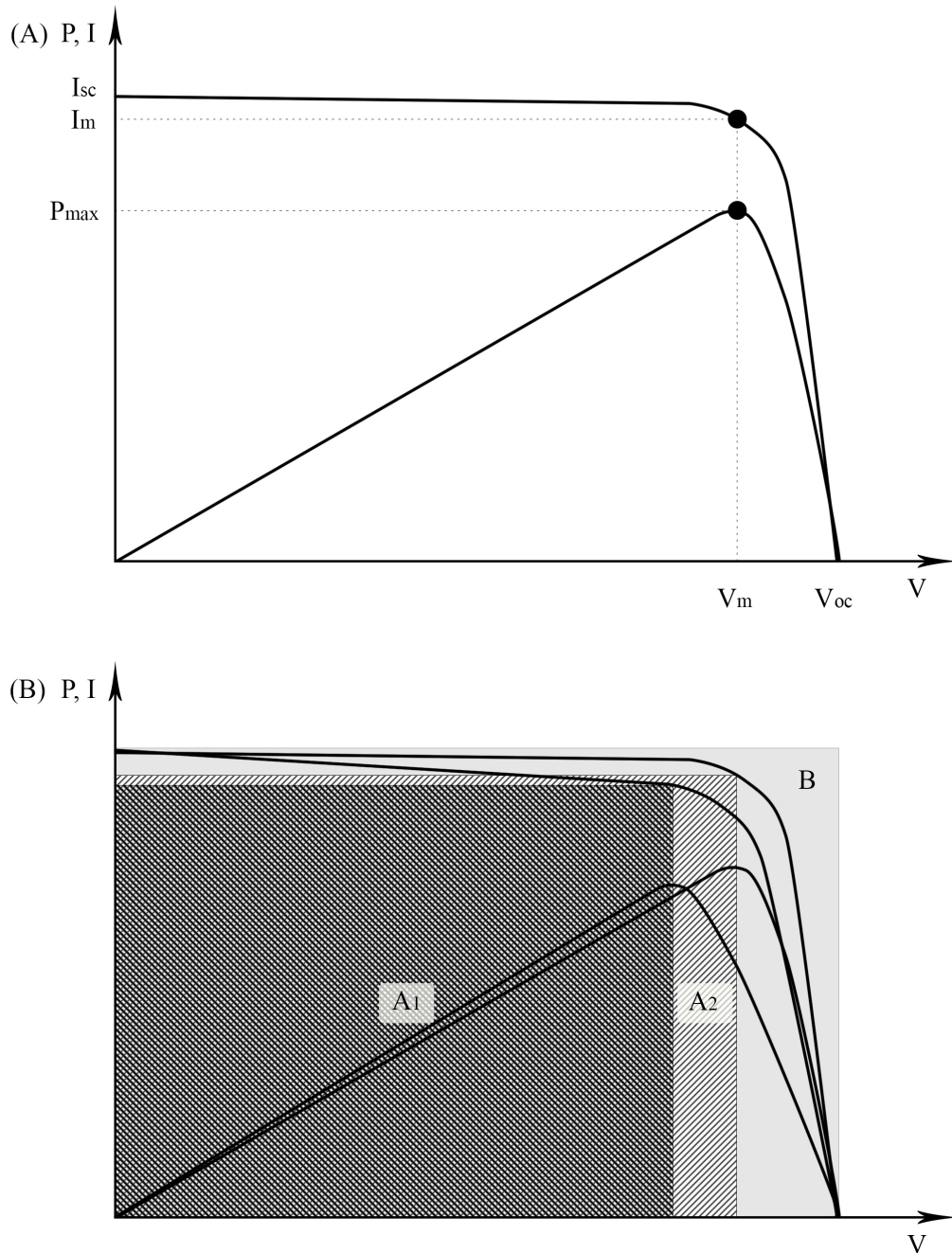

Figure 1.4. The voltage-current and voltage-power characteristics of ideal PV cell (A) and FF comparison of two cells (B) [6, 12]

From equations (1) and (3) it is clearly visible that temperature plays a huge role in cell's performance. Photo-generated current may change due to defects in PV cell and module coating, snow and dust covering the unit, weather and atmospheric conditions.

1.4 PV performance

Performance of PV modules are measured under standard test conditions (STC): solar irradiance at 1000 W/m^2 , air mass of 1.5 G and temperature of cell at $25 \text{ }^\circ\text{C}$. [13] Usually measurements are done with specific device, called PV panel analyzer (Figure 1.5), which measures V_{OC} , I_{SC} , calculates P_{max} , I_m , V_m , efficiency and FF, builds current and power curves.



Figure 1.5. I-V400w, I-V Curve Tracer for maintenance and troubleshooting of photovoltaic systems [14]

Real operational conditions are usually different from STC, so real performance of module is also different from that, provided by manufacturer. Due to irradiation and temperature variation, performance of modules is mostly lower in real life application. PV cell current has a linear dependency on irradiance level, voltage – logarithmic. Weather and atmospheric conditions alongside with geographical location, day-night cycle and time of the year, dust, dirt and snow layer accumulated on module's surface, all these factors form varying irradiance level, which resolves in

varying power output. [6, 15] For silicon wafer based PV cells efficiency is pretty much stable in relation to irradiance variations between 100-1000 W/m². For some cells efficiency reached at this irradiance range is better than at STC, due to lower losses at series resistance. Due to logarithmic dependency of V_{oc} efficiency below 100 W/m² drops also logarithmically. For irradiance level starting at 200 W/m² FF stays constant for majority of silicone based cells. [16]

Though PV modules use sun light to generate electricity, majority of incoming solar irradiation dissipates as heat which increases temperature of whole module and affects the performance. Heat has negative impact for convenient PV modules. Different mounting techniques can be applied in order to remove heat. [17] Figure 1.6 shows the relation between module temperature in relation to irradiance of building integrated PV modules depending on mounting method. [18]

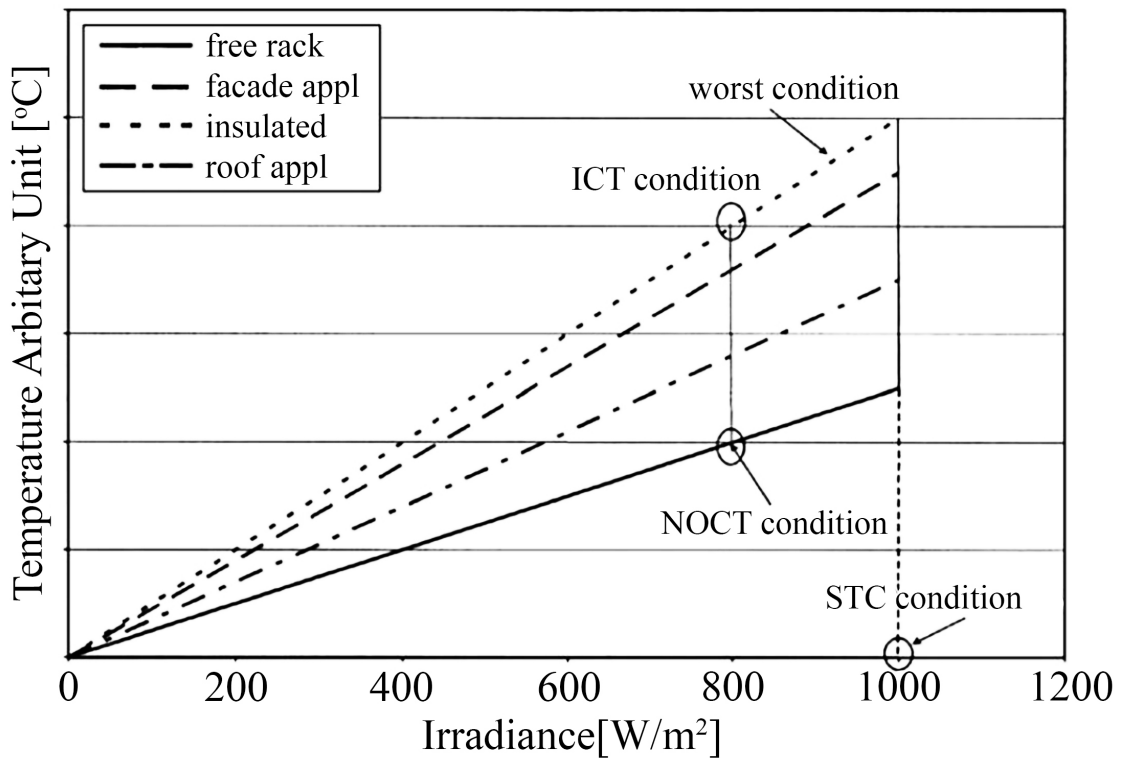

Figure 1.6. Temperature difference in relation to irradiance [18]

Partial shadowing is potentially harmful effect that occur in PV modules which occurs due to non-uniform irradiation spread across the module. When PV cell in chain is trapped in shadow, it starts working as a load instead of supplier. Shadowed cell gets hot due to resistivity and may cause damage to itself and as a result to whole module. Unfortunately in some situations it is almost impossible to avoid partial shadowing and in order to minimize consequences bypass diodes are used. These diodes allow current to bypass shadowed or broken cell, allowing PV module to produce electricity with some voltage and current decrease. [20]

Soiling is another factor that affects performance of PV panels. This can be a real problem in regions with dry and hot climate where wind blows masses of dust and sand, accumulating them on a surface of PV modules. For different areas losses due to soiling may vary. It depends on climate and environmental conditions and can reach up to 25%. Though for domestic usage soiling may seem to be not a big problem, but for commercial generation on big power stations this could cause big financial losses. [19]



Figure 1.7. PV panel soiling [19]

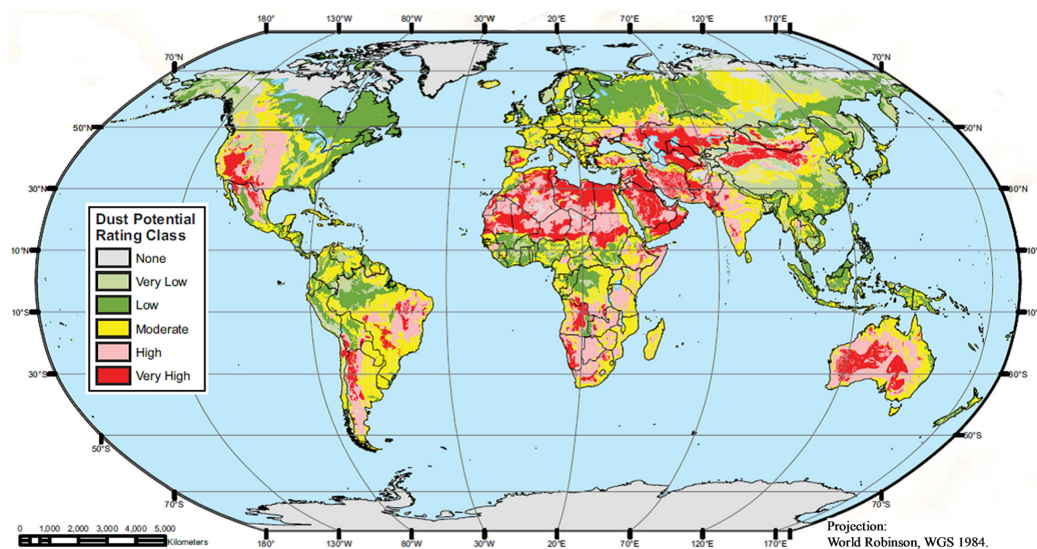

Figure 1.8. Dust potential around the globe [29]

Forehand maintenance and cleaning should be performed in order to keep production on same level and prevent money loses. Planned periodic cleaning is one solution for this problem, but soiling rate is not constant and may not fit with scheduled maintenance. Also cleaning operations could be costly, time consuming and unprofitable in relation to loses caused by soiling.

Some companies provide special materials that serve as coatings for PV panels and reduce dust accumulation rate, some provide tools for easier or automated cleaning, others create systems that detect and analyze dust cover to signalize if cleaning is necessary.

Pannel Plus are working on special coating for PV modules, based on Titanium Dioxide. Material changes its qualities depending on day/night cycle. Under sunlight it works as a regular coating which provides light and reduces reflection and glare effect. During night time and with absence of sunlight, surface becomes more hydrophobic and dust particles slide of it. [19]

Belectric, Ecoppia, Indisolar and others provide automatic cleaning solutions - robots that slide across modules and clean the surface.

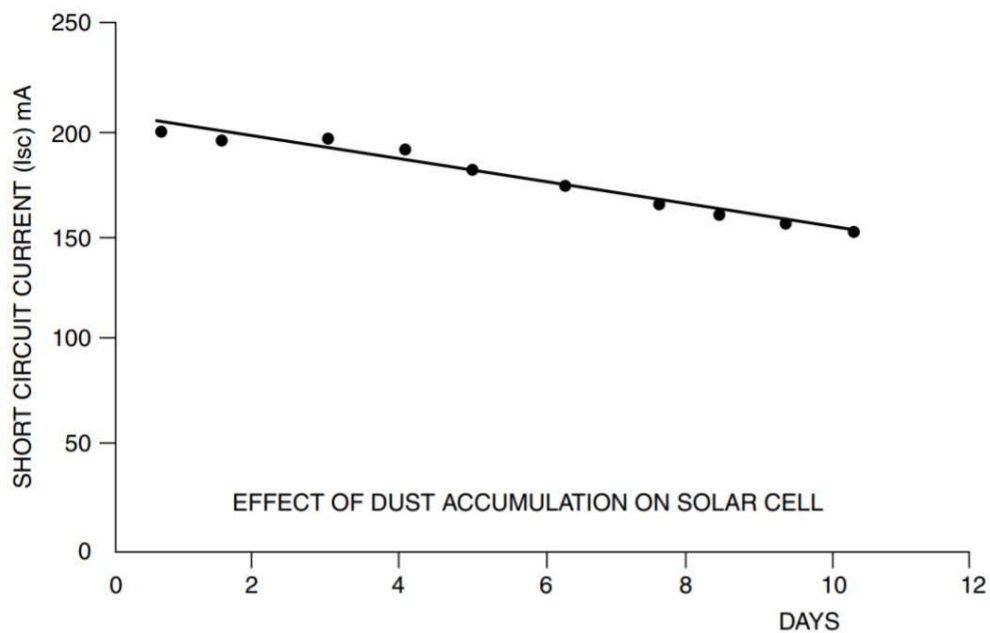

Figure 1.7. Soiling effect on short-circuit current of mono-silicon PV cell [15]

Atonometrics provide soiling measurement system, based on reference method. Their approach is based around power output comparison of modules that are in operation and clean reference module. [23] Soiling would cause losses in power output of PV modules installed, while clean reference module would have its initial performance. Comparing performance of two modules it's easy to make an idea about how much dust or dirt is accumulated on panels.

German Aerospace Center with Mohamed Premier University in collaboration with CSP Services and Plataforma Solar de Almeria, designed a solar tracking device that measures soiling

through reflectiveness of mirror. Mirror, affected by soiling, will reduce its reflectivity and light sensor would detect the decrease of irradiance coming from it. [24]

Also there are researches about infra-red (IR) soiling detectors. Their operation is based on IR beam that is emitted on surface affected by dust. This beam may get “caught” by dust layer, signaling about soiling issue. [25]

2. PRACTICAL PART

2.1 Experiment overview

Goal of this research was to create a system that will detect dust layer on surface of a module and measure its impact on module's performance. We decided to build our system based around light reflected from the surface of the dust which covers PV. Instead of using external device to analyze the cover, light source was embedded within the panel. During night time, light from this source will be reflected back by layer of dust on the module.

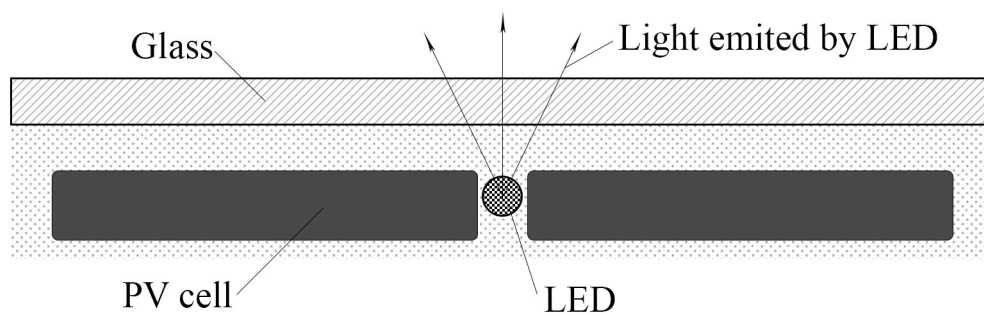

Figure 2.1. PV module with embedded LED

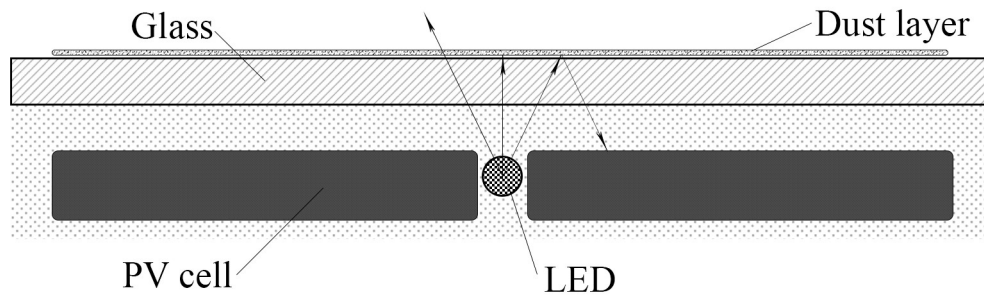

Figure 2.2. PV module with embedded LED with dust layer on front surface

Figures 2.1 and 2.2 show the schematic of PV module with LED embedded near the light sensor. Pretty much any modern PV cell can act as a light sensor, we decided to use the module's own cells instead of installing dedicated sensor.

Turning on the LED, it will emit light outside through the front surface. In clean state, glass is transparent and allows majority of light to pass through. Adding dust layer to the glass surface blocks the light path. Depending on thickness of this layer, some amount of light emitted by a LED

may be absorbed, some let through and some reflected back to the module. Reflected light forces PV cell to generate extra current which will depend mainly on layer thickness. Measuring this current, we can make assumptions about dust and soiling level, and also about losses caused by them.

During practical part series of experiments were performed with different configurations and different conditions.

2.2 Small-scale test

In the beginning we decided to try out if the concept works and how our LEDs would survive whole manufacturing process. During assembly, PV panels are going through intensive thermal and pressure treatment. LEDs were definitely not intended to be used under such conditions. Process of thermal and pressure treatment is called lamination and is necessary for our PV panels. Before lamination PV module is presented as a number of components stuck together and covered by glass (Figure 2.3 (A)). Pressure and high temperature melts filling material of the panel, in our case its Polyolefin, which in the end provides structural integrity and protects all components from mechanical damage and external factors. Polyolefin looks like white plastic cloth and after thermal treatment solidifies and turns transparent. Figure 2.3 (B) shows the end result – monolith construction, ready for mounting and testing.

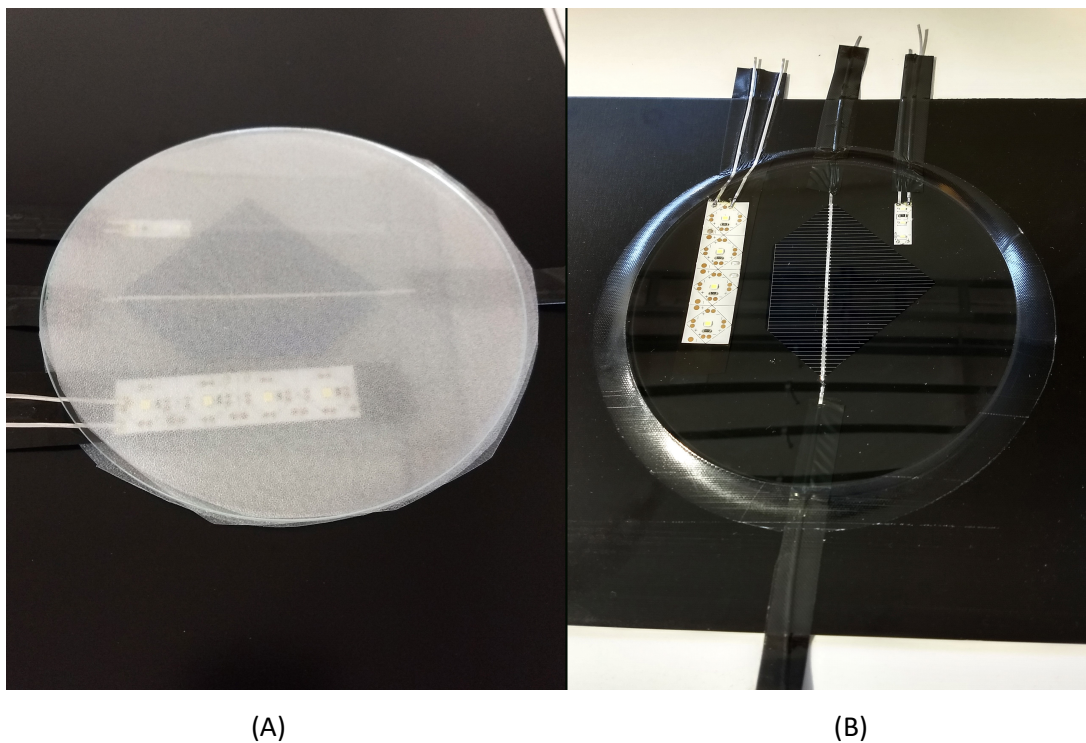

Figure 2.3. Test module before (A) and after (B) lamination

For our first test module we used a piece of shattered PV cell and couple strips of two different LED types. Main criteria for LEDs was thickness. Whole setup should not be thicker than 1 mm, otherwise pressure in laminator would be distributed nonuniformly and there is a chance for breaking components or glass.

From figure 2.3 (B) it's clearly visible that lamination process went well, all components are working. The larger strip of LEDs moved 5 mm away from the cell piece. Dislocation was caused by melted Polyolefin that was pushed out of the module by high pressure.

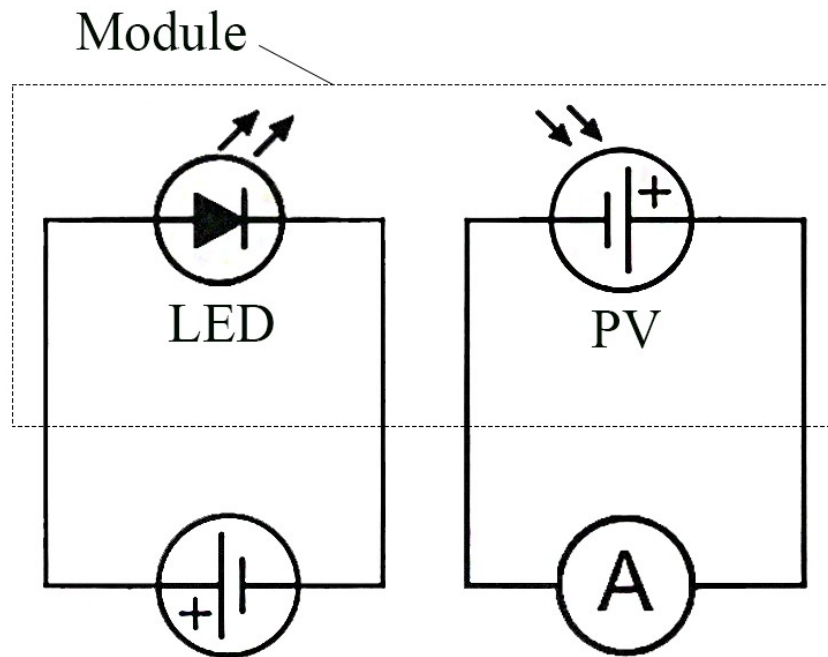

Figure 2.4. Experiment schematic

The concept worked, at least in small scale. Figure 2.4 shows the experiment schematic. To power LEDs we used two 9-volt batteries. Covering glass increased current generated by PV cell. For current measuring Brymen BM837 multimeter was used.

2.3 Full-scale test

The next step was to make a series of tests with module that has proper intact cells. At the same time there was another project in the facility that had a goal of integrating LEDs into a commercial PV panel. Decision was made to use that module in future experiments. Module is shown in Figure 2.5. Panel itself is made of 3 rows of 8 cells each and has two strips of LEDs installed on both sides of it. Unfortunately LEDs were pushed from the cells by pressure in laminator.

Majority of LEDs were outside of the panel and were not covered by glass, so this panel was not suitable for our test.

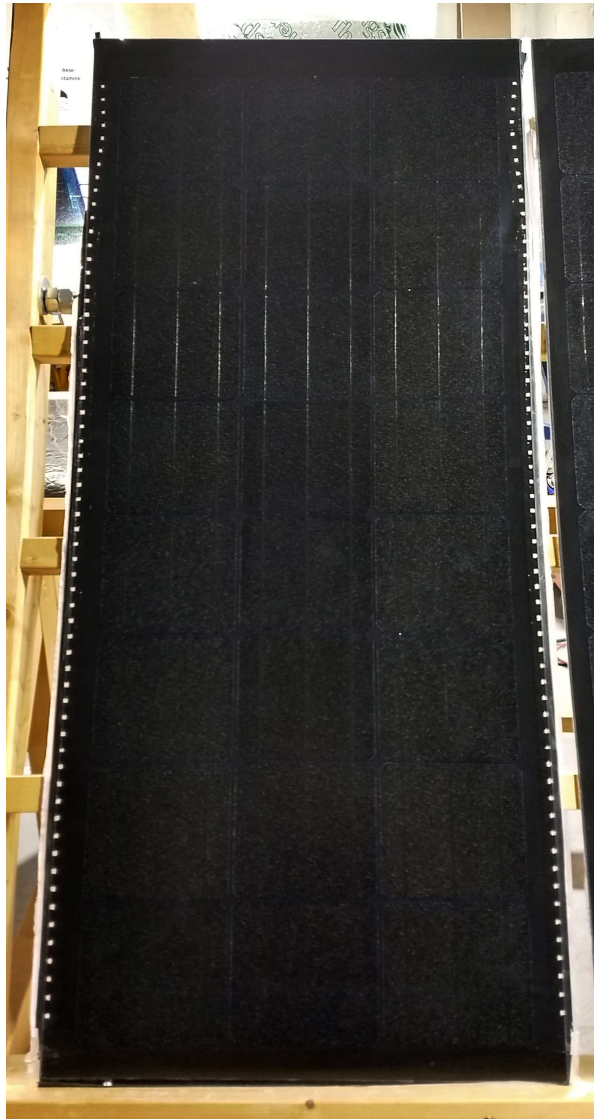

Figure 2.5. First full scale module with LED strips pushed out from the glass

For the next module, we installed LED strips between cell rows. This time results were much better. LEDs were held in place by PV cells. Figure 2.6 shows the panel without (A) and with (B) illumination turned on. Also with this type of installation, light from LEDs is covering all three rows of cells, in various extent, while in first module middle row was completely untouched.

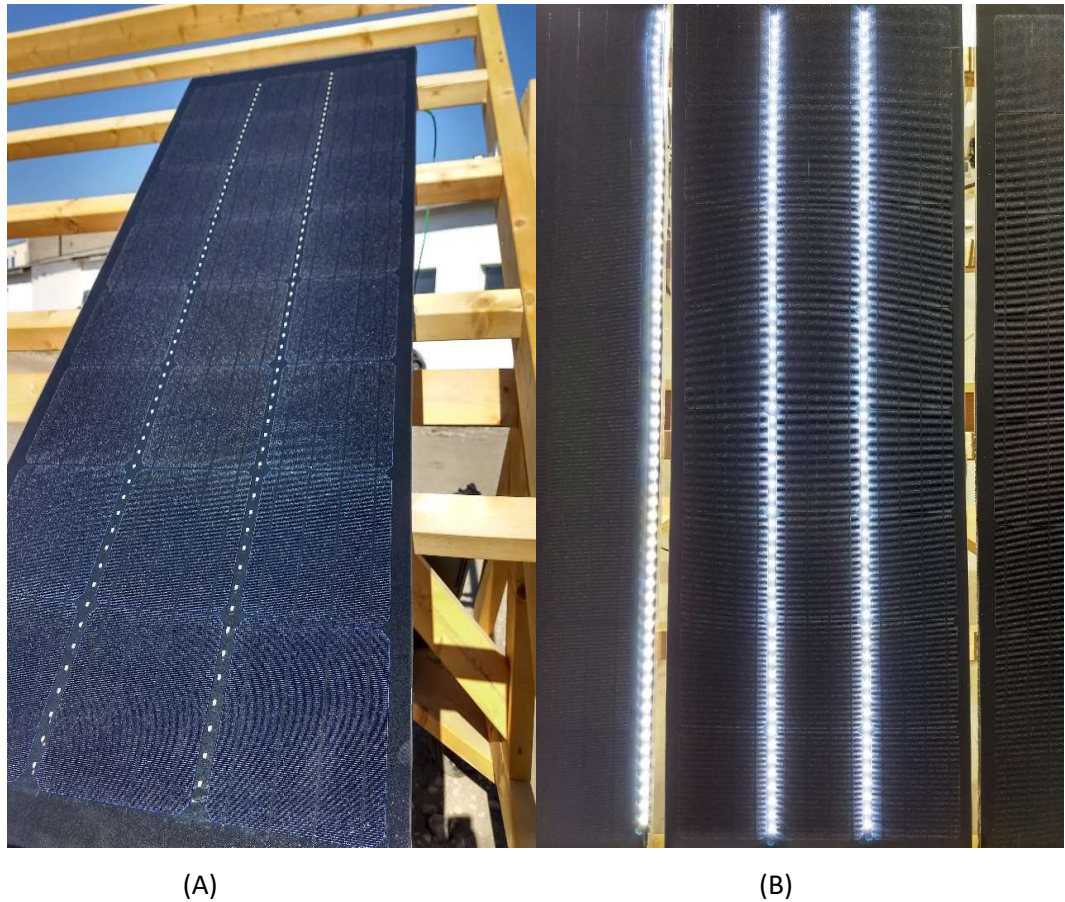

Figure 2.6. Second full-scale test module with LEDs off (A) and on (B)

The module itself has P_{\max} of 108 W and FF of 0.79, which is average performance for silicon-based module.

With second panel we performed a series of tests with dust layer. In these tests we applied multiple dust layers on top of the panel and measured short circuit current with and without LEDs turned on. Measurements were made for clean module and after each new dust layer added. As mentioned before, current has linear dependency to irradiance, while voltage – exponential, so measuring current will provide us better results and make system more sensitive. I_{sc} of our panel is 8.55A under STC and can be safely measured by any lab multimeter.



Figure 2.7. Characteristics of second module, measured by PV analyzer HT I-V 400w

Experiment with second panel took place in manufacturing facility during daytime, so there was some amount of ambient light present. For this experiment we took measurements of short-circuit current of panel under ambient light (I_{amb}) with LEDs turned off, then short-circuit current of ambient light with LEDs on (I_{ambLED}), from which we can calculate current generated by LEDs only:

$$I_{LED} = I_{ambLED} - I_{amb} \quad (2.1)$$

Also we used halogen lamps that provided around 100 W/m^2 on surface of PV panel to partially simulate real working conditions. Measuring current of module illuminated by lamps (I_{lamp}) would provide us an idea about losses from dust layer. Results are presented in table 2. During the test we were increasing dust amount 5 times in total, starting from clean panel – 0 under “Dust level” in table 2.

Table 2. Short-circuit currents of tested PV module with different dust amounts

Dust level	I_{amb} , mA	I_{ambLED} , mA	I_{LED} , mA	I_{lamp} , A	I_{lamp} , %
0	1.35	34.30	32.95	0.50	100
1	1.24	35.90	34.66	0.44	88
2	1.14	34.50	33.36	0.43	86
3	1.05	35.30	34.25	0.43	86
4	0.98	35.60	34.62	0.42	84
5	0.84	34.00	33.16	0.38	76
6	0.79	34.30	33.51	0.36	72

The results we received were not as good as expected. Firstly, as power source for LEDs we used 24V battery which, as turned out later, did not provide stable power output. Voltage variation on LEDs led to varying amount of irradiation and as a result to varying I_{ambLED} . Also irradiation from halogen lamps, we used for measuring losses in dust cover, was not distributed evenly across module's surface. We will do another test with halogen lamps with smaller sample later.

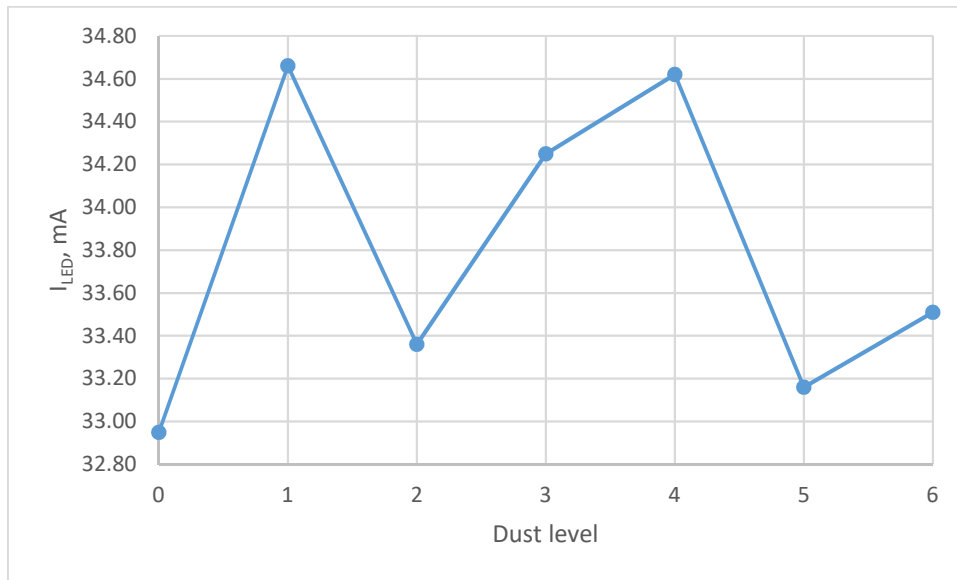

Figure 2.8. Short circuit current generated from LEDs' irradiation

Figure 2.8 represents dependency between current, generated by PV cells from light emitted by two strips of LEDs and reflected back from the glass surface. The current is all over the place, mainly due to bad power source for LED strips, and thus it does not provide any useful

scientific information. For future tests we decided to take proper laboratory DC power supply that will provide stable power output for LEDs.



Figure 2.9. Hyelec DC power supply

Shading effect should also be taken into consideration. Our LEDs are located between cell rows and illuminate middle row from both sides, while left and right rows only from one side. This means that current, generated only by LEDs, will be limited by current of left and right cell rows. In theory, I_{LED} from middle cells should be twice higher than from other cells. Design of our module allows to utilize each PV cell row individually.

Table 3. Short-circuit current comparison of whole module and middle cell row only

	I_{amb} , mA	I_{ambLED} , mA	I_{LED} , mA
Whole module	3.01	23.61	20.60
Middle row only	2.67	47.90	45.23

Table 3 represents difference in short-circuit currents of whole module and middle row only. From table it's clearly visible that current generated from LEDs' light is more than twice higher in a row which was illuminated from both sides. Also impact of ambient irradiation is a bit smaller, which will result in better accuracy.

Next test was performed in much darker environment in order to get less interference from ambient light. Measurements were taken from middle cell row only.

Table 4. Short-circuit currents in dark environment with varying dust level

Dust level	I_{amb} , mA	I_{ambLED} , mA	I_{LED} , mA
0	0.09	45.70	45.61
1	0.03	47.80	47.77
2	0.01	50.00	49.99
3	0.00	50.50	50.50

Table 4 shows how short-circuit current changes with different amount of dust applied on PV module's surface. 0 under "Dust level" means clean surface and 3 – almost 3 mm thickness dust layer. As dust for this experiment we used baking flour, which was added on the glass surface of the module layer by layer. Of course baking flour is completely different from dust and sand that usually accumulates on PV panels, but it has fine grain and can provide enough info for our further research.

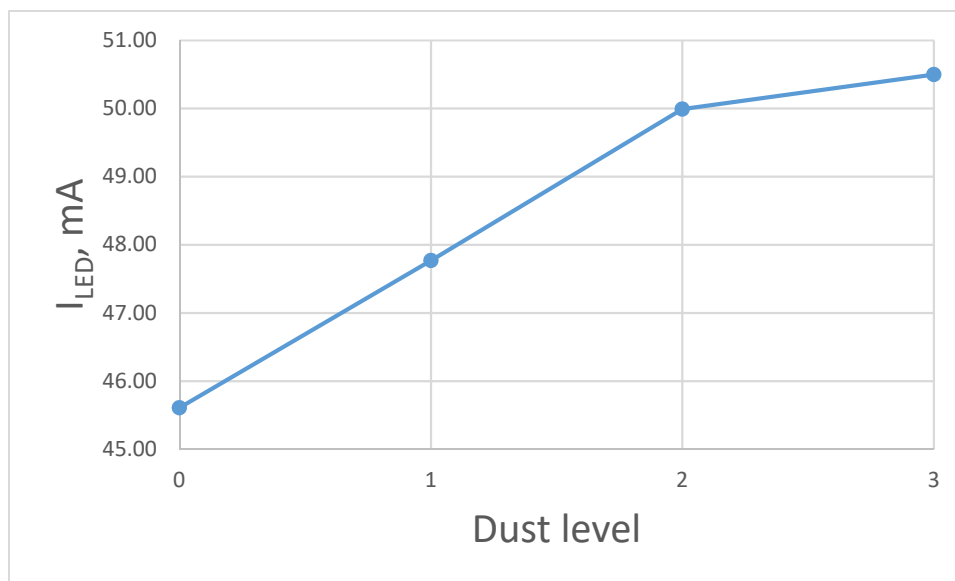

Figure 2.10. Relation between short-circuit current generated by LED light and dust level

From figure 2.10 we can clearly see that I_{LED} rises as more baking flour was applied to PV module. Thicker layer of dust reflects more light back to the panel generating extra current which can be used to analyze losses in power output of whole module.

Another question is the sensitivity of this detection method. Currents generated by reflected LED light are very small compared to ambient light in real environment. Skylight, street illumination, traffic headlights can provide significant amount of irradiation that will interfere with

our system. In order to withstand those interferences detection system should have higher sensitivity to LED light reflected from the glass surface and be able to filter ambient light.

By looking closer to the module, there are few things worth mentioning. PV panel is covered by tempered glass, which has texture on it. This texture reduces reflection and glare, increasing amount of light passing through the glass, allows to “trap” light which was bouncing from the cell surface. [22] This tempered glass also affects the light coming from LEDs inside the panel.

Another thing that caught attention was the distance between LEDs and PV cell. Glass and filling material defuse and reflect LEDs’ light back to the module even without any dust cover. For next experiment we decided to check how distance from embedded light source to the cell affects dust detection.

2.4 LED distance test

For the next experiment we created another small test-module, consisting of one full cell and 4 pairs of LEDs, located on different distances from the cell.

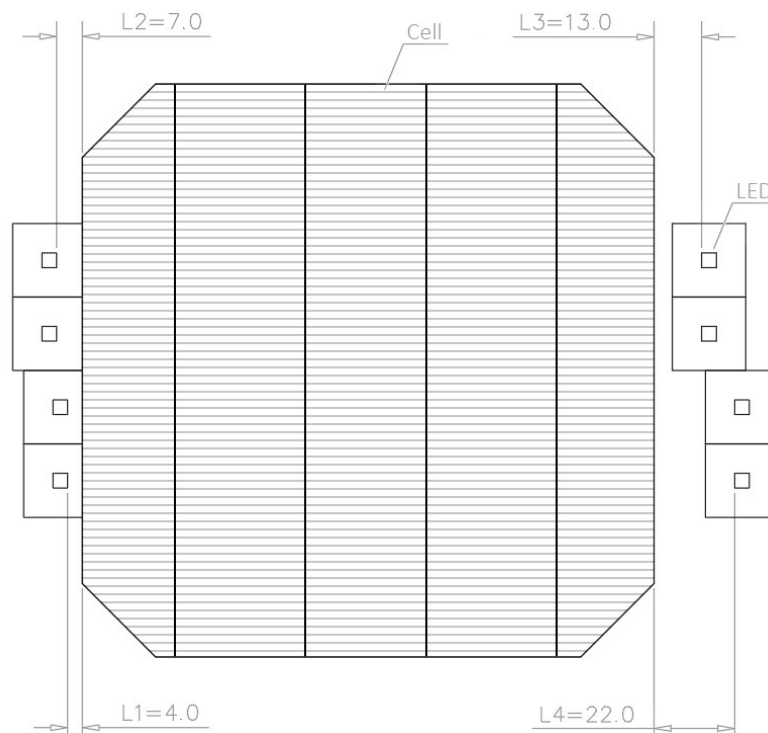

Figure 2.11. Panel schematic for LED distance test

Figure 2.11 shows four pairs of LEDs located at distances 4, 7, 13 and 22 mm away from the cell’s edge. LEDs were distributed in such way so the reflected from the glass light would cover cell evenly and then moved away on distances mentioned.

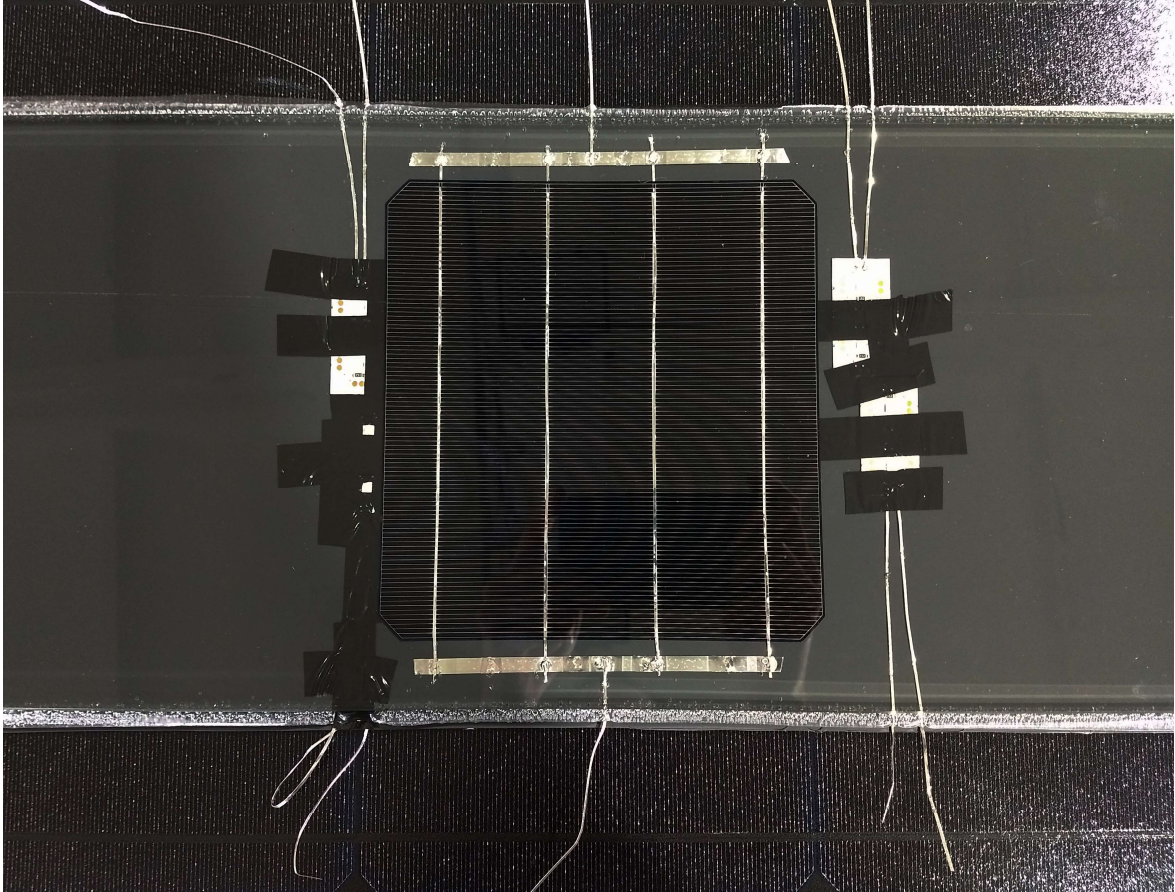

Figure 2.12. Laminated module ready for LED distance test

This test was performed in completely dark environment. Like in previous tests short-circuit current of a panel was measured. One pair LEDs was turned on at a time. After measuring currents with each pair, a layer of flour was applied to the glass. Results are represented in table 5. I_{clean} – short-circuit current, generated by LED light only, reflected from clean glass surface; I_{dust1} , I_{dust2} , I_{dust3} – short-circuit currents, generated by LED light, which was reflected from glass with different amount of flour. ΔI_{dust1} – current increase after adding first layer of dust to clean surface, ΔI_{dust2} – current increase after adding second layer of dust and ΔI_{dust3} – current increase after adding third layer of dust to the glass.

Table 5. Short-circuit currents and current increase in relation to distance and dust level

Distance, mm	I_{clean} , mA	I_{dust1} , mA	I_{dust2} , mA	I_{dust3} , mA	ΔI_{dust1} , mA	ΔI_{dust2} , mA	ΔI_{dust3} , mA	ΔI_{dust1} , %	ΔI_{dust2} , %	ΔI_{dust3} , %
4	7.16	8.20	8.37	8.38	1.04	0.17	0.01	14.53	2.07	0.12
7	4.48	5.04	5.11	5.13	0.56	0.07	0.02	12.50	1.39	0.39
13	2.77	3.27	3.35	3.35	0.50	0.08	0.00	18.05	2.45	0.00
22	0.77	0.87	0.90	0.90	0.10	0.03	0.00	12.99	3.45	0.00

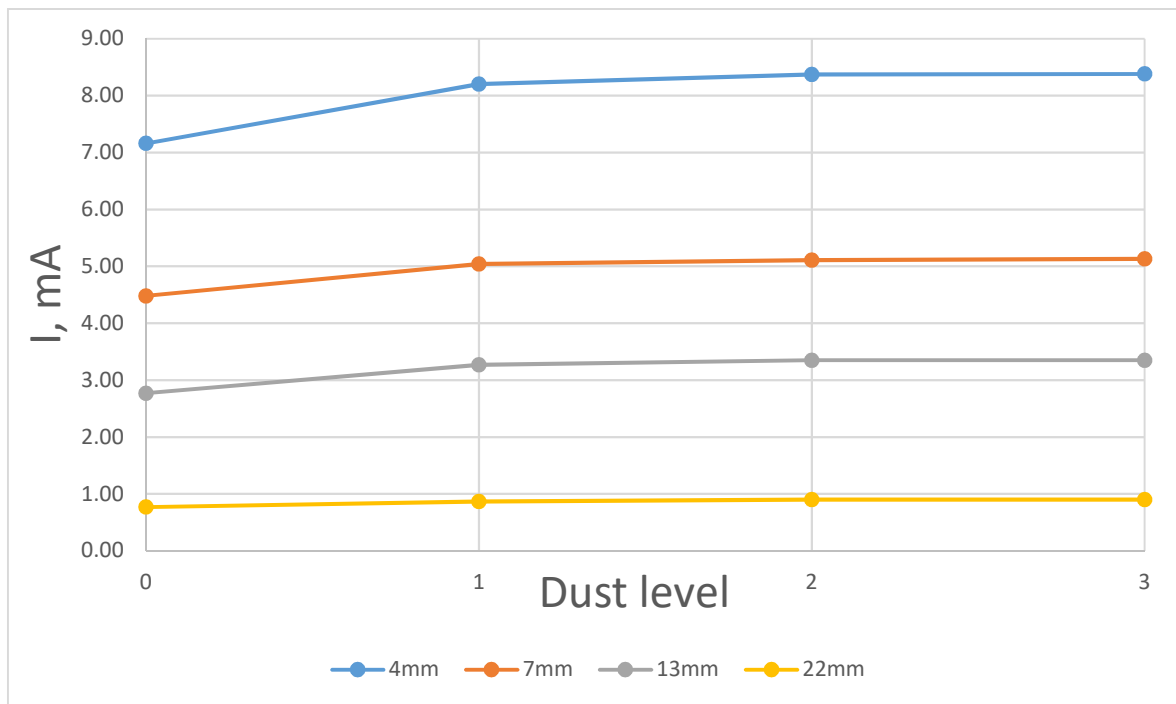

Figure 2.13. Relation between current and dust level for different distances between LEDs and PV cell

Figure 2.13 provides visual representation of short-circuit currents generated from all 4 sets of LEDs in relation to dust level, where 0 – no dust, 1, 2, 3 – three dust levels added. From this figure we can clearly see that the highest absolute current value is provided by LED couple located at 4 mm distance – the closest one from the four. But the main goal of this test is to see which installation has higher current increase, in other words, higher sensitivity.

Figure 2.14 shows how current increases with each new dust layer applied. Figure 2.15 shows the same but in percentage from absolute value.

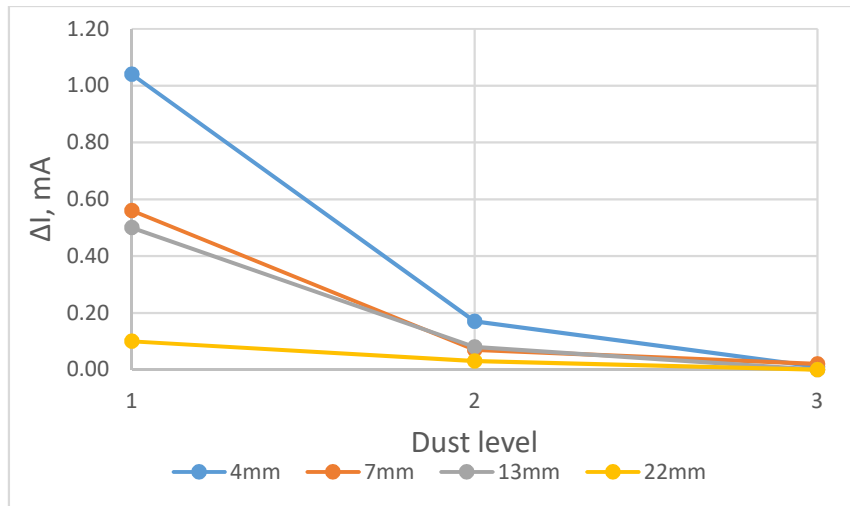

Figure 2.14. Sensitivity of dust detection system for different distances between LEDs and PV cell

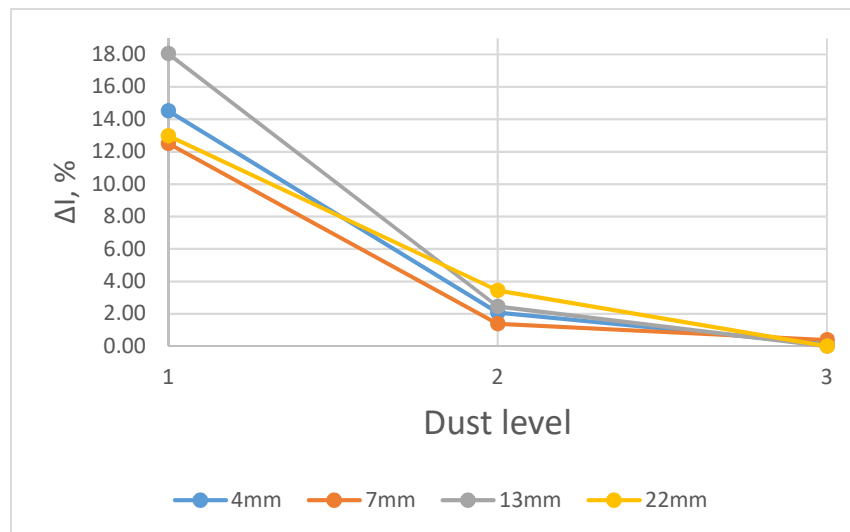

Figure 2.15. Sensitivity of dust detection system for different distances between LEDs and PV cell, in percent

According to figure 2.14, the higher increase in current belongs to LEDs located closest to the cell. Though percentage increase for 13mm distance is better, according to figure 2.15, the absolute current value and current increase in amperes is too small and it would be harder to detect in real environment, due to high amount of ambient light. For practical application it would be better to install LEDs as close to the cell as possible.

2.5 Dust detection and losses

For last experiment we wanted to see the relation between losses, caused by dust, and currents, generated from reflected LED lights. We used the same one-cell module, used for previous test and three 1000 W halogen lamps. Lamps provided irradiation of 110 W/m^2 and concentrating on small one-cell panel was not an issue. Lamps were used to simulate sunlight and current generated by it is representing the output of the module. Covering panel with dust would block lamp light from coming to PV cell. As a result cell would generate less current with each new dust layer.



Figure 2.16. Kanlux 1000W halogen projector lamps

During this experiment we were measuring short-circuit currents generated by LED lights (I_{LED}) and short circuit currents generated by halogen lamps (I_{lamp}) while adding more and more dust to the module. By the end of experiment, module was covered with thick layer of powder, which blocked almost all light from lamps. Losses in panel caused by dust are inversely proportional to I_{lamp} .

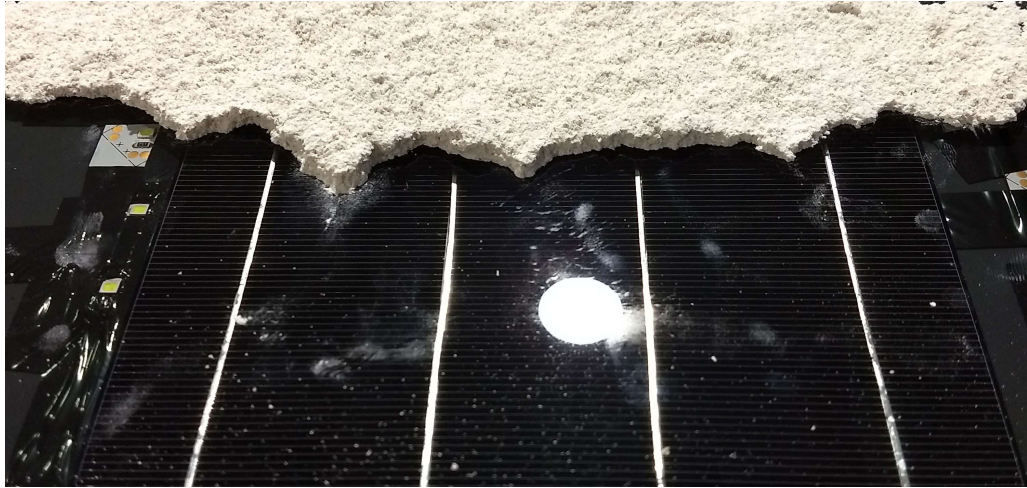

Figure 2.17. Thickness of powder layer at the end of experiment

Table 6. Short-circuit currents generated by one-cell PV module with varying dust level

Dust level	I_{amb} , mA	I_{ambLED} , mA	I_{LED} , mA	I_{lamp} , mA	I_{lamp} , %	ΔI_{lamp} , %
0	4.40	11.51	7.11	243	100.00	0.00
1	1.93	9.87	7.94	236	97.12	2.88
2	0.95	9.09	8.14	219	90.12	7.00
3	0.58	8.86	8.28	183	75.31	14.81
4	0.33	8.65	8.32	120	49.38	25.93
5	0.30	8.66	8.36	85	34.98	14.40
6	0.18	8.55	8.37	63	25.93	9.05
7	0.12	8.50	8.38	43	17.70	8.23
8	0.11	8.48	8.37	28	11.52	6.17
9	0.05	8.43	8.38	17	7.00	4.53
10	0.03	8.41	8.38	9	3.70	3.29

Based on results of experiment, we can build a graph that shows relation between currents of reflected LED light and drop of current generated by halogen lights. In figure 2.18 we used I_{lamp} , in percent for better understanding how sensitivity of dust detection system is related to soiling level.

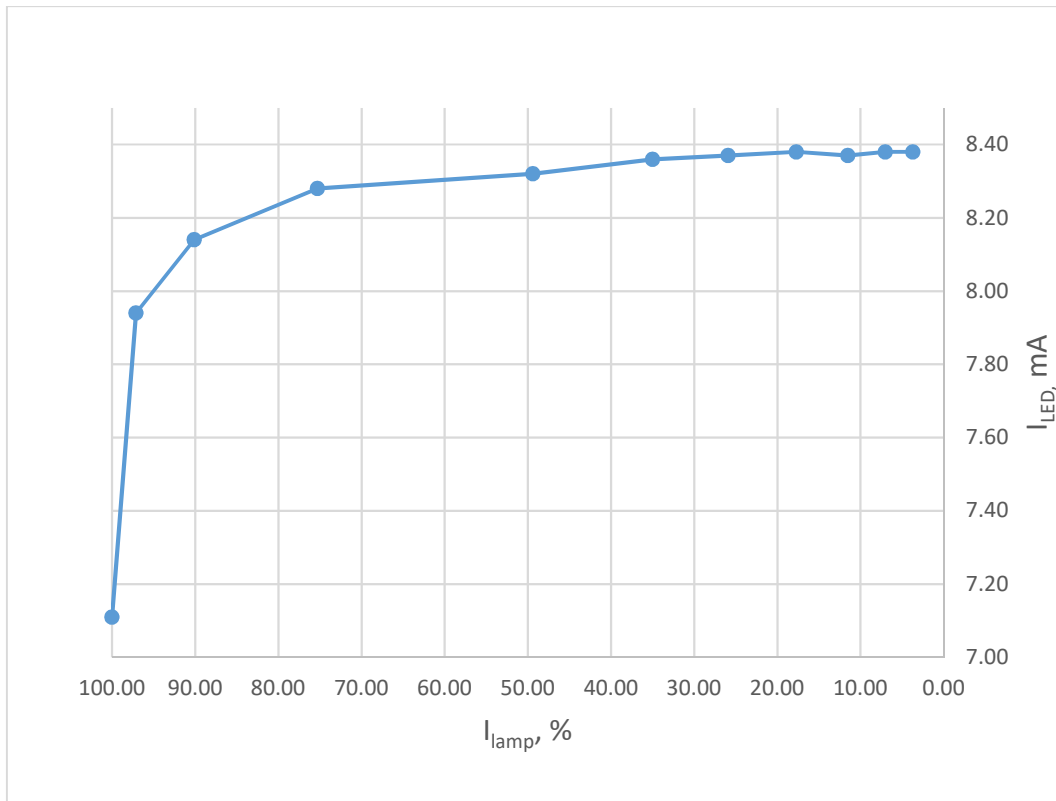

Figure 2.18. Relation between LED-generated and halogen lamp-generated currents

From figure 2.18 we can clearly see that the highest increase of I_{LED} falls into interval when I_{lamp} is dropping from 100 to 75 percent. From 75%, current increase starts to diminish significantly. This means that dust detection works best at the interval when losses, caused by soiling, are below 25%.

3. CONCLUSIONS

The goal of this research was to create a system that will detect and measure dust layer on top of PV module. We created couple modules with integrated LEDs and tested them under different conditions. Despite all skepticism, LEDs survived thermal and pressure treatment. The results showed that soiling level can be detected without any external sensors and without using reference PV panels. LED light, reflected by dust layer on the surface of the glass back to the panel, can be sensed by module's PV cells. Though amount of light can be very small and it depends on amount, location and power of installed LEDs. Currents generated by this reflected light have extremely small values and can be easily lost due to currents caused by ambient light. System must be able to filter out the ambient light in order to be used in real environment. To make system more sensible and stable, LEDs should be located as close to the cells as possible. Also measurements should be taken only from cells that are most affected by LEDs' light, otherwise current would be limited by the current of less illuminated cell.

The tests also showed, that dust detection system is most sensitive at the beginning of soiling process, when losses in PV performance are below 25%. This is actually very good, because the goal of this system is to monitor and warn operator about status of PV module in order to perform cleaning in right time and maintain module's maximum performance.

To power LEDs a steady power source is necessary. In the beginning, the plan was to use rechargeable batteries, so they can be charged during the day and provide power to dust detection system at night. But as experiments shown, batteries are a bit unstable as power source and can cause errors during measurements.

4. PROBLEMS TO SOLVE

Though experimental part show that this technology is possible, it's still far away from commercial application. A series of tests and improvements should be made in order to turn this project to life.

As mentioned earlier our panels use tempered glass with texture. This texture reduces reflection and glare, allowing more light to come through the glass, traps reflected light in order to increase module's performance. Texture also affects light emitted by our LEDs, installed inside the panel. Other parameters of glass, like its thickness and refraction indices, should also be taken into consideration. A series of tests with different glass coatings, different textures and different glass thickness should be performed.

In full-scale test we had only one panel with two LED stripes located between cell rows. For future, more tests with different LED amount and different setup should be performed in order to maximize LED irradiance and increase system's sensibility.

The other problem that should be solved is ambient light. Ideally, to provide the most correct results, our dust detection system should work in complete darkness. But even in darkest night, there is some amount of light that will fall on PV module and generate current that will affect our system. Especially this would be noticeable in urban areas, where street illumination, traffic headlights and lights from nearby buildings would provide constantly changing irradiation level. To filter currents, generated by ambient light, we can use lock-in technique.

Lock-in amplifier uses knowledge about the wave-length of signal needed and can extract it from the background noise. [26] Figure 4.1 shows working principle of lock-in amplifier. Amplifier compares reference signal V_r and input signal V_s which contains lots of noise and extracts only signal that has same frequency.

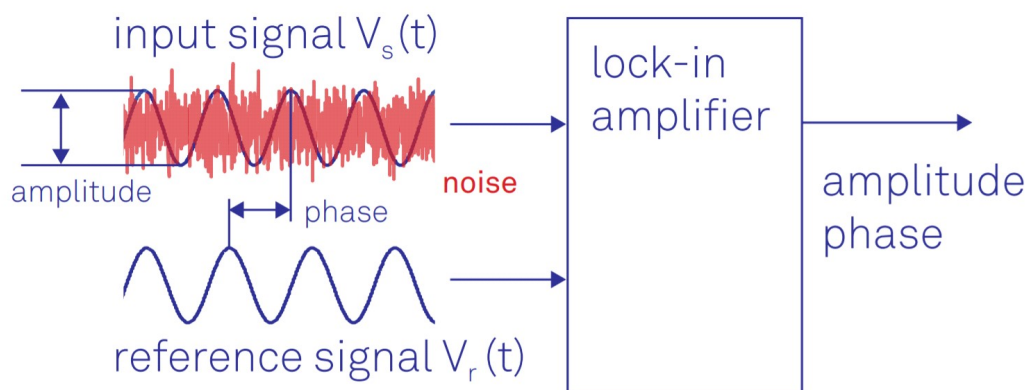

Figure 4.1. Lock-in amplifier principle [26]

For our system, LEDs could be powered by varying voltage of high frequency. PV cell would generate current from LEDs light which would have same frequency. Based on this frequency, lock-in amplifier can extract this current from ambient noise and amplify it. But again, this may introduce new problems as well as increase complexity of whole system. LEDs should be tested in order to see if they can emit light with such frequency, due to possible delay in their response time.

5. FUTURE PLANS AND DEVELOPMENT

In order to be useful in real-world application, dust detection system must be automatic and should have some data center to store and analyze measurement results. Specific software should be created for data center. This software will analyze relations between currents, power output and based on all data will provide info about soiling level, necessity of cleaning and maintenance and potential power and money losses.

Before analyzing data, it should be sent from module to the data center. An interface should be created, through which raw data will be transmitted from the site with panels to the data center. There are several ways to send measurement results:

- by using extra pair of cables;
- using wireless technologies, like radio transmission and Wi-Fi;
- by power line from PV modules with help of optocouplers.

Our original idea was to use power line that connects PV modules with main grid. The goal was to create a simple system and minimize amount of cables on the site. With this setup, measurements from PV module should be sent through optocoupler to main power line. Optocoupler uses light or IR beam to transmit signals between two separate systems. It consists of LED transmitter, which transforms electrical current into light and photosensitive receiver that converts light back into electrical signal. [27]

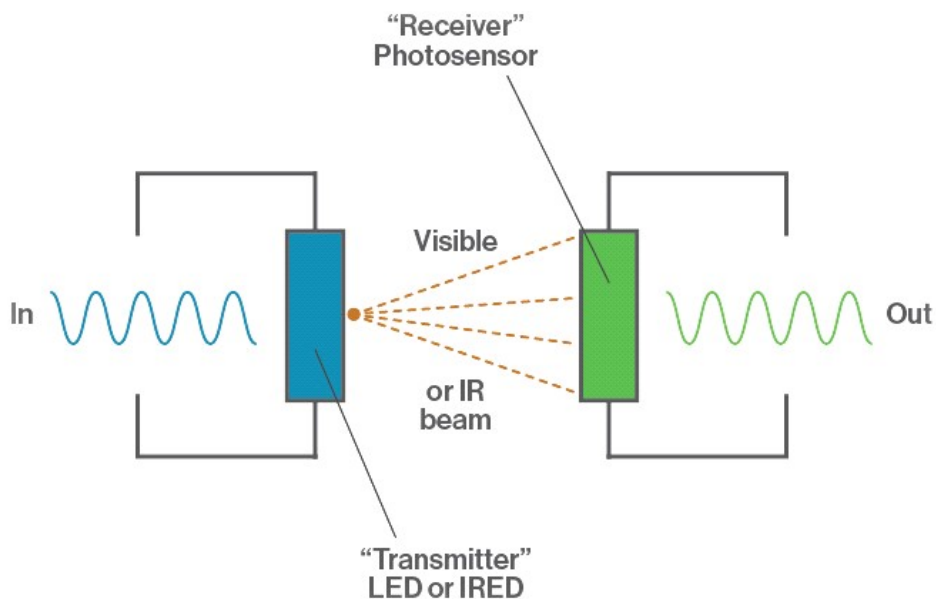

Figure 5.1. Optocoupler work principle [27]

With optocouplers there will be no galvanic connection between power line and dust detection system inside the module. Signal would be sent by main power cable to the data center and will be filtered there. Also with this setup, we can power our LEDs using same power line.

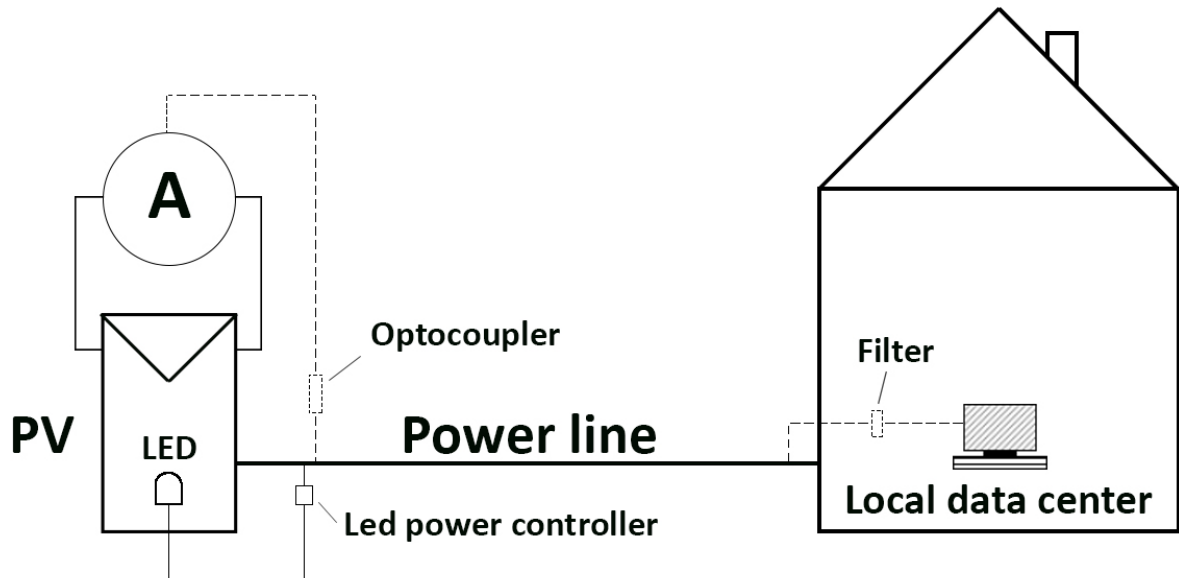

Figure 5.2. System setup

Popularization of new sustainable energy sources leads to emerging of new ways of their sensing and control. Smart grids are appearing in order to provide better communication between technology and customers, automation, reliability and security of energy generation and distribution. [28] In smart grids each component of the system is connected to the control unit, which acts as brain and provides easy access for operator to status and control features.

One of the best possible applications for our PV panel would be in couple with such smart grid system. Panel with integrated dust detection system, power optimizer, thermometer, can provide all data to smart grid. Based on this info, smart grid's control center can manage power consumption and distribution more precisely.

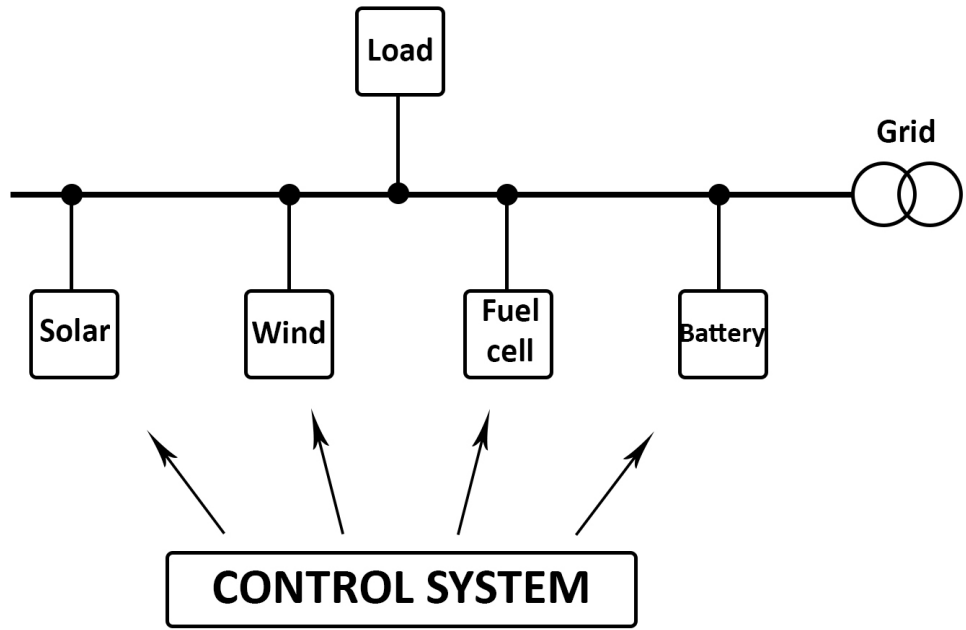

Figure 5.3. Smart grid system

SUMMARY

The aim of this study is to develop an automatic dust cover detection system for PV panels, which uses reflectivity of dust layer and is integrated into the module. System is based on using LEDs, embedded into the panel, which emit light from the module. Based on dust layer on top of the glass cover, amount of light, reflected back to the panel, will change. This light can be measured by light sensor to provide an idea about dust thickness and its influence on module's performance.

During this research multiple test PV modules were created, including a full-scale panel. First small module served as proof of concept, showing that LEDs can be successfully integrated into the panel without melting or shattering and without damaging any other components. It also showed that dust detection system can work, at least in lab environment.

Other modules were used for actual experiments related to dust detection. In these experiments we were measuring short-circuit currents generated in these modules from ambient light, LEDs and halogen lamps. As light sensor PV cells of module were used. Full-scale module consisted from 3 rows of 8 PV cells each, with two stripes of LEDs installed between them. Test results showed that there is relation between dust amount and currents generated by reflected light. Also it is essential to take measurements only from cells most affected by LEDs' light.

Another small module was made with one cell and four couples of LEDs located on different distances from the cell. This module was used to check what impact distance has on our dust detection system. In order to maintain better sensitivity it was chosen to locate LEDs as close as possible to cells.

Test with halogen lamps was also performed with this module. As a result of this test we got relation between losses in module's performance and dust layer thickness. System is most sensible in the beginning of soiling process, when losses due to dust accumulation are below 25%.

Multiple problems were located during the research. Glass surface of our tempered glass has texture that is applied in order to increase an amount of light coming to cells inside the panel. This texture modifies reflectivity and diffuses light coming from LEDs. Different glass types with different thickness and texture should be tested in future.

Another problem we found is ambient light which interferes with light from our system. Currents generated from LEDs' light have small values and any irradiation incoming from outside will affect measurements. In order to fix this issue, a way to increase system's sensitivity should be found. Also lock-in technique can be applied.

In order to have practical application, panels with dust sensor must have a system that will gather and analyze data. Interface through which measurements from modules should be developed.

LIST OF REFERENCES

- [1] "Solar PV Market Size, Share, Trends, Global Industry Report 2012 – 2020", Grand View Research, Inc., San Francisco, 2017.
- [2] "Solar, an Energy of the Future", Planète Energies, 2014, Available: <https://www.planete-energies.com/en/medias/reports/solar-energy-future>
- [3] "Energy Explained", U.S. Energy Information Administration, Washington, DC, January 16, 2018, Available: <https://www.eia.gov/energyexplained/index.php?page=home>
- [4] Askari Mohammad Bagher, Mirzaei Mahmoud, Abadi Vahid, Mirhabibi Mohsen, "Types of Solar Cells and Application". American Journal of Optics and Photonics. Vol. 3, No. 5, 2015, pp. 94-113. doi: 10.11648/j.ajop.20150305.17
- [5] "PROGRESS IN PHOTOVOLTAICS: RESEARCH AND APPLICATIONS" Prog. Photovolt: Res. Appl. 2017; 25:3–13 Published online 28 November 2016 in Wiley Online Library (wileyonlinelibrary.com). DOI: 10.1002/pip.2855
- [6] Kalogirou, Soteris A.. (2018). "McEvoy's Handbook of Photovoltaics - Fundamentals and Applications (3rd Edition)". Elsevier. Retrieved from <https://app.knovel.com/hotlink/toc/id:kpMEHPFAE7/mcevoys-handbook-photovoltaics/mcevoys-handbook-photovoltaics>
- [7] Kucklick, Theodore R. (2012). "The Medical Device R&D Handbook, Second Edition". CRC Press
- [8] CET Center for EcoTechnology, "Advantages and disadvantages of photovoltaics", Available: http://www.energybc.ca/cache/solarpv/www.cetonline.org/Renewables/PV_pro_con.html
- [9] Renewable Energy World, Dino Green, December 19, 2012, "Advantages and disadvantages of Solar Photovoltaic – Quick Pros and Cons of Solar PV", Available: <https://www.renewableenergyworld.com/ugc/articles/2012/12/advantages-and-disadvantages-of-solar-photovoltaic--quick-pros-and-cons-of-solar-pv.html>
- [10] "PHOTOVOLTAICS REPORT", Fraunhofer Institute for Solar Energy Systems, ISE, PSE Conferences & Consulting GmbH, Freiburg, 26 February 2018
- [11] "Photovoltaic Cell I-V Characterization Theory and LabVIEW Analysis Code", National Instruments, 10 May 2012, Available: www.ni.com/white-paper/7230/en/
- [12] "Fill Factor", PVEducation, Available: <https://www.pveducation.org/pvcdrom/solar-cell-operation/fill-factor>

- [13] "Standard Test Conditions (STC): definition and problems", SINO VOLTAICS, 4 November 2011
- [14] HT Instruments, Available: <https://www.ht-instruments.com/en/products/photovoltaic-testers/i-v-curve-tracers/i-v400w>
- [15] Gevorkian, Peter. (2012). "Large-Scale Solar Power Systems - Construction and Economics". Cambridge University Press. Retrieved from <https://app.knovel.com/hotlink/toc/id:kpLSSPSC2/large-scale-solar-power/large-scale-solar-power>
- [16] N.H. Reich, W.G.J.H.M. van Sark, E.A. Alsema, R.W. Lof, R.E.I. Schropp, W.C. Sinke, W.C. Turkenburg, "Crystalline silicon cell performance at low light intensities, Solar Energy Materials & Solar Cells" 93 (2009) 1471–1481
- [17] Swapnil Dubey, Jatin Narotam Sarvaiya, Bharath Seshadri, "Temperature Dependent Photovoltaic (PV) Efficiency and Its Effect on PV Production in the World - A Review", PV Asia Pacific Conference 2012, Energy Procedia
- [18] J.J. BLOEM, "STUDY OF A HYBRID PV INTEGRATED BUILDING APPLICATION IN A WELL CONTROLLED TEST ENVIRONMENT", EC -JRC, Institute for Environment and Sustainability, Renewable Energies Unit, I - 21020 Ispra, Italy
- [19] "How much energy yield does a pv plant loose by the soiling effect?", Pannel Plus, 18/10/2017, Available: <http://pannelplus.divegroup.it/en/news-events#>
- [20] Mohamed Abd Al-Alim, Roaa I. Mubarak, Mohamed Elbably, "Optimization of Partially Shaded Photovoltaic Systems by Enhancing Maximum Power Point Tracking by using IPSO-PID", 2017 IEEE
- [21] Bend Mobile Solar, Available: <http://www.bendmobilesolar.com/Different-Types-of-Solar-Cells.htm?m=99%26s=726>
- [22] Mark Shields, "PV Systems: Low Levels of Glare and Reflectance vs. Surrounding Environment", Sunpower 2010
- [23] "Soiling Measurement System for PV Power Plants", Atonometrics, Available: <http://www.atonometrics.com>
- [24] Kipp & Zonen, "Tackling Solar Energy's Dust Problem", June 1 2015, Available: <http://www.kippzonen.com/News/606/Tackling-Solar-Energy-s-Dust-Problem#.WwKxdEiFNPY>
- [25] Rahul B. Ingle, Ravindra S. Chavan, Rameshwar R. Kondke, Nishant V. Mahadane, Vishnu D. Phuke, Prof. K. V. Nemade, "Automatic dust detection mechanism for solar panel cleaning system", Ijarie, 2007

- [26] Zurich Instruments – “White Paper: Principles of lock-in detection and the state of the art”, November 2016
- [27] Sam Sattel, Let There Be Light! How an Optocoupler Works, Eagle academy, Autodesk Inc, 2016
- [28] “What is the Smart Grid?”, Smartgrid.gov, Available:
https://www.smartgrid.gov/the_smart_grid/smart_grid.html
- [29] McDonald, Eric V, “Integrated Desert Terrain Forecasting for Military Operations (DTF)”, Desert Research Institute, 2012