



**Aalto University**

MEHAANIKATEADUSKOND

Masinaehituse instituut

**EMD70LT**

*Rainer Klein*

## **CRUISE SHIP CONCEPTS APPLYING LNG FUEL**

*LNG kütuse rakendamine kruisilaevadel*

Autor taotleb  
tehnikateaduste magistri  
akadeemilist kraadi

Tallinn

2016

## AUTORIDEKLARATSIOON

Deklareerin, et käesolev magistritöö on minu iseseisva töö tulemus.

Esitatud materjalide põhjal ei ole varem akadeemilist kraadi taotletud.

Töös kasutatud kõik teiste autorite materjalid on varustatud vastavate viidetega.

Töö valmis ..... DSc Kristjan Tabri..... juhendamisel

“.....” .....2016 a. Töö autor ..... allkiri

Töö vastab magistritööle esitatavatele nõuetele

“.....” .....2016 a. Juhendaja ..... allkiri

Lubatud kaitsmisele

..... õppekava kaitsmiskomisjoni esimees

“.....” .....2016 a.

..... allkiri

TTÜ masinaehituse instituut

## Magistritöö ülesanne

2015/2016 õppeaasta 2. Semester

Üliõpilane: 130375MATMM

Õppesuund: Laevaehitus

Juhendaja: DSc Kristjan Tabri, MSc Olli Somerkallio

Konsultant(did): Professor Pentti Kujala

LÕPUTÖÖ TEEMA (eesti ja inglise keeles):

*CRUISE SHIP CONCEPTS APPLYING LNG FUEL*

*LNG kütuse rakendamine kruisilaevadel*

Lõputöös lahendatavad ülesanded ja nende täitmise ajakava:

Nr	Ülesande kirjeldus	Täitmise tähtaeg
1	Kirjanduse ning tehtud töö ülevaate koostamine	15.05.2015
2	Lahendatavate probleemide püstitus	30.05.2015
3	Mõjutegurite analüüs	15.07.2015
4	Ülevaate koostamine alternatiivsetest lahendustest	30.8.2015
5	Juhtumiuuringu teostamine	15.10.2015
6	Töö lõpuleviimine	30.10.2015

Lahendatavad insenertehnilised ja majanduslikud probleemid:

Mõjutegurite tuvastus ja analüüs, alternatiivsete masinsüsteemide tehniline võrdlus, operatiivsete tegurite analüüs, juhtumiuuringu koostamine ja nüüdisväärtuse leidmine.

Kaitsmistaoetus esitada dekanaati hiljemalt 12.01.2016 Lõputöö esitamise tähtaeg 13.01.2016

Üliõpilane /allkiri/ .....kuupäev.....

Juhendaja /allkiri/ ..... kuupäev.....

## Lühikokkuvõte

Veeldatud maagaas on perspektiivikas laevakütus. Tegemist on selgelt puhtama ja keskkonnasäästlikuma alternatiiviga hetkel populaarsetele kütuseliikidele. Selle kasutamine ei ole aga alati majanduslikult arukas ning vastavad tasuvusarvutused tuleb teha iga laeva jaoks eraldi. Seni avaldatud kirjanduses pole uuritud selle rakendamist kaasaegsetel kruisilaevadel. Autori eesmärk on antud tühimik täita.

Viimastel aastatel on heitgaasi piirangud merenduses muutunud oluliselt rangemaks. Veeldatud maagaasi kasutamine aitaks vähendada nii süsinikdioksiidi, vääveloksiidide kui ka lämmastikoksiidide hulka heitgaasis. Kuni nafta hinna hiljutise languseni oli maagaas senistest kütustest märgatavalt odavam.

Autor leidis, et mootoritest tasuks eelistada segakütus-mootoreid (mille hulka kuuluvad ka mõned gaasiturbiinide mudelid). Ainult gaasi kasutamist lubavad mootorid ei ole hetkel praktilised puuduliku tankimisinfrastruktuuri tõttu. Erinevatest kütusepaakide lahendustest väärivad enim tähelepanu prismaatilise kujuga disainid, mis on märgatavalt ruumisäästlikumad, kui hetkel enim kasutatud silindrilised paagid. Võttes arvesse kaotatud ruumi maksumust on antud lahenduste rahalise hetkeväärtuse vahe 9 MUSD.

Koostatud masinasüsteeme võrreldi populaarsete alternatiivsete lahendustega – madala väävlisisaldusega kütuse kasutamine ja heitgaaside puhastamine. Arvesse võeti nii laeva ruumi väärtust, erinevate masinasüsteemide kütusekulu, hoolduskulusid ja heitgaasi puhastussüsteemidele omaseid kulusid.

Töö tulemusena võib väita, et hetkel ei ole veeldatud maagaasi kasutamine kruisilaevadel majanduslikult otstarbekas. Heitgaase puhastava süsteemi hetkeväärtus on 26 MUSD, samas kui segakütusemootori ja primaatilise paagiga süsteemi väärtus on 7 MUSD ning segakütusemootori ja silindrilise paagiga süsteemi väärtus -2 MUSD (võrreldes madala väävlisisaldusega kütuse kasutamisega).

## Abstract

LNG has become a feasible fuel alternative. In many aspects it is favorable to the standard marine fuels but the economics deserve case-by-case analysis. Comprehensive reports have been published for various operating areas and ship types, but very little material exists on its application on cruise ships. The aim of the thesis is to provide an overview of available technologies and identify those better suited for the cruise industry.

Increasingly stringent pollution regulation can be considered the primary driver of LNG adoption. During the past few years LNG has also been considerably cheaper than HFO but this has changed in the recent months.

It was found that dual fuel four stroke engines and aeroderivative gas turbines with waste heat recovery were most promising. Pure gas engines remain unpractical at this point for cruise ships. Although commonly IMO C-type tanks have been used, prismatic designs also deserve attention due to their significantly smaller footprint.

The composed concepts were compared to operation on low Sulphur fuel and exhaust gas cleaning. The value of deck area is determined and used to assign a value to space lost or gained. The exhaust gas cleaning system consumables, as well as maintenance and overall plant efficiency are considered. It is concluded that LNG has merit in the cruise industry but currently the economics are not favorable. It was determined that compared to the base case of operating on low Sulphur fuel, choosing an LNG machinery system has a NPV value of \$7M compared to \$26M for scrubber installation.

If the price of HFO in Miami were to rise from the current \$279 to \$330, LNG would again become the cheaper fuel (assuming its price remains constant). It is concluded that LNG has merit for the cruise industry and many feasible machinery concepts exist. Yet using the presented figures, the economics are rather in favor of exhaust gas cleaning.

## **Acknowledgements**

The work contained in this thesis was completed in a coordinated effort between Aalto University and Foreship Ltd. My education in the university's Marine Technology department has proven to be a very solid basis for future work in the field.

I am very grateful for the wealth of information and assistance provided to me by Professor Pentti Kujala from Aalto University and to my instructor Olli Somerkallio from Foreship Ltd. Both men provided me with much needed guidance and motivation. Among the specialists who provided valuable information were Markus Aarnio from Foreship Ltd. and Tomas Aminoff from Wärtsilä Oyj Abp. I must also extend gratitude towards industry professionals from other companies without whom this work would have far less substance.

The process was slightly more time-consuming and difficult than I had expected. Still, I am very happy with the process as well as the final result.

Thank You

Espoo, 2015

# Table of Contents

Lühikokkuvõte .....	iv
Abstract .....	v
Acknowledgements .....	vi
Table of Contents.....	vii
List of figures .....	ix
List of tables .....	x
Acronyms and abbreviations .....	xi
1 Research area .....	1
1.1 Introduction .....	1
1.2 Research questions .....	1
1.3 Research scope .....	2
1.4 Research methods.....	2
1.5 Thesis structure .....	2
1.6 Summary .....	2
2 Literature review .....	4
2.1 General reports.....	4
2.2 Case studies .....	5
2.3 Academic research .....	7
2.4 Industry research.....	7
2.5 Books .....	7
2.6 Conclusion.....	8
3 Drivers of change .....	9
3.1 Air pollution regulations .....	9
3.2 Effluents .....	13
3.3 Economics of LNG.....	13
3.4 Conclusion.....	17
4 Options.....	18
4.1 Conventional options .....	18
4.2 Unconventional options.....	19

4.3	LNG as the new marine fuel.....	19
4.4	LNG-compatible prime movers .....	21
4.5	Exhaust gas treatment .....	26
4.6	Energy system concept .....	28
4.7	Fuel containment.....	30
4.8	Regulatory framework .....	36
4.9	Causes for concern .....	37
4.10	Conclusion.....	40
5	Case study.....	42
5.1	Ship characteristics.....	42
5.2	Cases.....	42
5.3	Cost components.....	44
5.4	NPV comparison .....	48
5.5	Sensitivity analysis.....	50
6	Conclusion and discussion.....	54
6.1	Overview of research outcomes.....	54
6.2	Discussion and future considerations .....	55
7	References.....	56
8	List of appendices.....	65
	Appendix A .....	66
	Appendix B .....	68
	Appendix C .....	69
	Appendix D .....	70
	Appendix E.....	72



## List of figures

Figure 1: Emission control areas in the Americas.....	11
Figure 2: Emission control areas in Europe.....	11
Figure 3: Citygate price.....	14
Figure 4: Fuel price comparison.....	16
Figure 5: Price of gas among regions.....	17
Figure 6: 4-stroke gas engine product range.....	23
Figure 7: Gas engine market.....	24
Figure 8: Component placement.....	27
Figure 9: Power plant type energy system.....	29
Figure 10: Fuel handling system.....	29
Figure 11: IMO tank types.....	30
Figure 12: LNG carrier with type A tanks.....	31
Figure 13: B-type spherical tank.....	32
Figure 14: B-type prismatic tank 2.....	32
Figure 15: C-type tank with a gas valve unit.....	33
Figure 16: C-type bi-lobe design.....	33
Figure 17: GTT membrane fuel tank.....	34
Figure 18: LNG facilities.....	38
Figure 19: THC reduction of LNG Dual Fuel.....	39
Figure 20: Possibility of abnormal combustion for lean burn gas engines.....	40
Figure 21: Initial and recurring costs of abatement options.....	49
Figure 22: Net present value comparison.....	50
Figure 23: Recurring costs.....	51
Figure 24: NPV vs HFO price.....	52
Figure 25: NPV vs ECA ratio.....	52
Figure 26: NPV vs ECA ratio (2).....	53

## List of tables

Table 1: In-force and possible future ECAs .....	10
Table 2: Emission limits .....	12
Table 3: LNG emission benefit .....	13
Table 4: Cost of marine fuels .....	15
Table 5: Compliance options.....	18
Table 6: LNG composition .....	20
Table 7: Fuel energy density .....	20
Table 8: Pure gas and DF engine comparison.....	25
Table 9: LNG tank comparison.....	36
Table 10: Scrubber OPEX.....	44
Table 11: Fuel cost estimates.....	46
Table 12: Fuel consumption.....	46
Table 13: Berths and cabins .....	47
Table 14: Value of area.....	47
Table 15: Effect of machinery footprint of vessel value .....	48

## Acronyms and abbreviations

ABS	American Bureau of Shipping
AGT	aeroderivative gas turbine
BD	biodiesel
BMEP	brake mean effective pressure
CAPEX	capital expenditure
CNG	compressed natural gas
DNV	Det Norske Veritas
DNV GL	Classification society resulting from the merger of DNV and GL
ECA	emission control area
EEDI	IMO Energy Efficiency Design Index
EGCS	exhaust gas cleaning system
EGR	exhaust gas recirculation
EMSA	European Maritime Safety Agency
EPA	U.S. Environmental Protection Agency
CU	gas combustion unit
GD	gas-diesel engine
GE	General Electric Company
GHG	greenhouse gas
GL	Germanischer Lloyd
GT	gross ton
GVU	gas valve unit
HFO	heavy fuel oil
IHI	Ishikawajima-Harima Heavy Industries
IMO	International Maritime Organization
LNG	liquefied natural gas
LSFO	low Sulphur fuel oil

MAN	MAN Diesel & Turbo SE
MARAD	U.S. Department of Transportation Maritime Administration
MARPOL	International Convention for the Prevention of Pollution from Ships
MDO	marine diesel oil
MEPC	Marine Environment Protection Committee
MGO	marine gas oil
MMBtu	one million British thermal units
MSC	IMO Maritime Safety Committee
NECA	NOx emission controlled area
NOx	collective term for Nitrogen dioxide (NO <sub>2</sub> ) and Nitrous Oxide (NO)
OPEX	operating expenditure
PM	particulate matter
SECA	SOx emission controlled area
SFC	specific fuel consumption
SOx	collective term for Sulphur trioxide (SO <sub>3</sub> ) and Sulphur dioxide (SO <sub>2</sub> )
THC	total hydrocarbon
USCG	United States of America Coast Guard
WHR	waste heat recovery

# 1 Research area

The current chapter presents the reader with the framework in which the thesis was written. The research problem, scope and methods are defined.

## 1.1 Introduction

Emissions are now a global concern. Greenhouse gases increase the temperature of our planet [1], Sulphur and Nitrogen oxides (SO<sub>x</sub> and NO<sub>x</sub>) are harmful to human health and ecosystems [2]. It is technically possible to reduce all these emissions.

In recent years there has been much published on the outlook and implementation of liquefied natural gas (LNG) as marine fuel. The common high level conclusion is that LNG is beneficial for ecologic reasons, but the economic viability should be assessed for specific cases. Studies have been performed and published regarding its use on LNG carriers, container vessels and trawlers, but similar information for cruise ships cannot be found.

The thesis presents an analysis of currently available methods for using natural gas on an average newbuild cruise ship.

## 1.2 Research questions

The cruise industry is in a rather peculiar intersection. There the traditional nature of marine transport meets with the safety standards and high expectations of the hotel industry. A new technology here will not gain much for simply being different. A great deal of inertia is built into the whole system due to the high cost of vessel conversion, the capabilities of existing infrastructure and crew training. To begin assessing the possible future of LNG in this field, the benefits and drawbacks must first be clearly studied.

### **What are the benefits and disadvantages of switching to LNG as a ship fuel?**

The purpose of the machinery system is to provide all required energy for ship propulsion, operation and hotel needs. At the same time the requirements for safety and cost should be observed. A preliminary analysis should be performed to see which concepts deserve deeper analysis.

### **Which LNG machinery concepts are practical on a cruise ship?**

Many options are academically intriguing and entirely possible yet still not actively pursued. In the end what determines the success and failure of technologies in industry, is cost. Having assessed the suitability of LNG as a marine fuel, the cost of this switch should be studied. Many competing solutions should be analyzed as the cheapest option might not turn out to be the obvious one.

## **What is the most cost-effective machinery solution for adopting LNG as fuel on for cruise ships?**

Having answered the final question, the aim of this thesis will have been reached. The reader will learn if and under which conditions LNG can be used as fuel on cruise ships.

### **1.3 Research scope**

Without clearly defined limitations, a thesis will never be ready. It is paramount to find a scope which provides the most useful knowledge while requiring the smallest amount of effort.

The machinery concepts will be compared for only one specific vessel - a 130 000 gross ton (GT) cruise ship designed in 2009 but never built. The analysis will focus on the main cost items – fuel tanks and engines.

As identified by DNV GL, the main drivers for LNG in North America and Europe are the availability of cheap gas and the creation of emission control areas (ECAs) [3]. Accordingly, these subjects will be given more attention, while the political and social factors will only be briefly covered.

The environmental comparison will be based on exhaust gas emissions. The economic comparison will be centered on the net present value method.

### **1.4 Research methods**

The thesis consists of a qualitative and a quantitative section. The former is based on the PESTEL format, where Political, Economic, Social, Technologic, Environmental and Legal aspects are considered. The quantitative section consists of a case study of alternative fuel solutions for a 130 000 GT cruise ship. Competing machinery concepts are introduced and thereafter compared. The thesis concludes with a recommended solution.

### **1.5 Thesis structure**

The thesis starts with a review of work previously conducted by various marine industry parties aiming to determine the utility of LNG. A gap in the current understanding is identified which the author aims to fill in the following chapters. This is followed by a brief overview of the underlying regulatory, technical and economic challenges. After presenting the possible machinery solutions, the more likely candidates are chosen. Finally an economic comparison of these solutions is performed.

## **1.6 Summary**

It is evident that the industry must move towards the utilization of cleaner fuels. The author feels that given sufficient research and time, LNG will become a major marine fuel. Will this be the case in the cruise industry? The following chapters aim to answer this question.

First the case for LNG fuel as whole will be studied. This is followed by a more concentrated look into the possible machinery concepts. Finally the best of these concepts will be studied on a techno-economical basis to yield a perspective on whether LNG has future in cruise ships.

## 2 Literature review

The primary aim of the literature review is to check whether the planned work has not already been undertaken and published. If indeed the direction seems novel, the review can provide many clues as to which branches deserve more attention.

The current chapter is dedicated to a review of the most thorough and beneficial works published in the area of LNG for marine transport. The material is divided into general overview reports, case studies and specialized research reports. Special attention is given to material relevant to the cruise industry and the Caribbean Sea region.

### 2.1 General reports

The recent move towards utilizing more LNG in marine transport is largely due to emissions regulations set by the International Maritime Organization (IMO) in the ripple of the Kyoto Protocol. How is LNG better than its many alternatives? What are the major benefits and drawbacks? Is the industry ready? These questions are answered in the comprehensive reports composed by various private and public sector organizations.

An overview of ship powering options can be obtained from a study conducted by The Royal Academy of Engineering, England [4]. Options such as heavy fuel oil (HFO), coal, anhydrous ammonia and gas-to-liquid are reviewed. Natural gas is considered a good short-term solution. It is a known technology so there is little resistance from authorities, service experience so far has been satisfactory, machinery changes are rather straightforward and the fuel offers operational savings. It is, however pure, still a fossil fuel and is thus not considered a decent long-term solution. Biogas and hydrogen should be considered as substitutes for natural gas once the industry reaches sufficient production capacities. The dual-fuel engines installed today are very capable of utilizing these upcoming “greener” fuels. Fuel cell technology is yet too expensive and immature to be used in such a scale. Solar and wind cannot offer sufficient power density to be considered prime mover technology. Nuclear energy is cheap and free of emissions but faces significant resistance due to negative public perception. It is still a feasible solution but will likely be utilized only in deep sea cargo transport.

A study commissioned by the Dutch Ministry of Infrastructure and Environment and published in May 2013 looked into ways in which natural gas could be utilized in the transport sector. The effects on greenhouse gas emissions, energy efficiency, pollutant emissions and costs were considered. It was concluded that for marine use, LNG allows for up to 20% reduction in greenhouse gas (GHG) emissions. This is often severely reduced due to methane slip. NO<sub>x</sub>, SO<sub>x</sub> and particulate matter (PM) emission reduction would be significant for deep sea vessels but well-to-wheel energy usage would increase by roughly 3...9% [5]. The report concludes that LNG offers some environmental advantages but in GHG emission and energy use may offer little significant advantage over conventional diesel.



Germanischer Lloyd (GL) conducted a study on the standards and rules of LNG bunkering for the European Maritime Safety Agency (EMSA) [6]. Based on gap analysis and interviews with industry participants, the report provides an overview of legislation that must be considered when designing marine LNG installations. The various ways of utilizing LNG in marine applications are neatly covered and a succinct overview of the processes can be obtained. Recommendations for further rule development are presented. The latest version was published in February 2013.

At the 2014 North American LNG Bunkering Summit industry participants agreed that outdated regulations and public opinion were the biggest barriers to the adoption of LNG as marine fuel [7]. It was also noted that the requirements of local, statewide and federal regulatory bodies often overlap or contradict. According to a representative of Port of Long Beach, an earlier attempt at adopting LNG for cruise ships was discarded after passengers were worried about their safety. Yet in light of the recent moves towards environmental friendliness, passengers are becoming much more supporting of new and cleaner fuels [7]. As Peter Keller, Executive Vice President of Tote Inc. reported: *“They understand that positive environmental change, even though you're not 100 percent sure about it, needs to be embraced”*.

In February 2015 the U.S. Coast Guard (USCG) published two policy letters on LNG operations. The first contains recommendations on LNG bunkering operations and training [8]. It includes guidelines for passenger or cargo loading while transferring fuel as well as the recommended equipment and procedures. The second letter provides information on the regulatory and safety issues concerned with vessels and waterfront facilities [9]. References for relevant standards and regulatory bodies are provided. There are few differences between these guidelines and those of EMSA but these documents should be consulted when planning LNG operations in the navigable waters of the U.S.

In December 2014 The American Bureau of Shipping (ABS) published its “Guide for LNG Fuel Ready Vessels” – a guide to preparing newbuildings for later conversion to LNG fuel [10]. This is a natural move as Det Norske Veritas (DNV) had offered such classification since 2013 [11]. Being deemed “LNG ready” allows ship-owners, currently skeptical of LNG, more flexibility to later move with the market trends.

In March 2015 ABS published its updated version of their guide for LNG bunkering in North America [12]. The bunkering options are described and compared, relevant regulations are presented in a simplified manner and operational guidelines are presented. The report concludes with an overview and outlook for LNG as marine fuel.

## **2.2 Case studies**

These studies aim to analyze the current move towards cleaner fuels in order to arrive at a quantifiable result on which further business decisions could be based. The level of detail concerning input information and methods is sometimes lacking. Furthermore, the recent

developments in fuel price, infrastructure and technology may deteriorate their utility. Yet such efforts have well aided the market penetration of gas fuels.

In 2011 MAN Diesel & Turbo (MAN) in cooperation with GL performed a joint study in the costs and benefits of LNG as ship fuel for container vessels [13]. The payback times for vessels were studied with regards to their time spent in ECAs and their cargo capacity. It was found that larger vessels operating at smaller ECA shares have the shortest payback time. It can be reduced further by installing a waste heat recovery (WHR) system. In the study the lost revenue from reduced cargo space and additional spare parts reserves were considered. As the cargo was only transported in one direction the reduction in cargo capacity was only considered for one leg of the journey. Finally, the numbers presented in the MAN and GL paper should be checked from more current sources.

The Danish Maritime Authority North European LNG Infrastructure Project report [14] does not go into much technical detail but provides a solid foundation for project cost and time estimation. Competing business cases are compared in light of capital and operating expenditures. Guidelines for dealing with authorities and the public are provided.

In 2014 DNV, by request of U. S. Marine Administration (MARAD), has performed a study of LNG bunkering [15] in the U.S. The current state of the required infrastructure as well as safety, regulations and training were analyzed. Recommended steps of improvement were described.

Multiple theses have been written on the topic, mostly by students of Nordic universities. The case for a container vessel operating in the North European ECA was studied by a student from Copenhagen Business School [16]. LNG was found to be the most environmentally friendly of the three compared abatement options – LNG, marine gas oil (MGO) and exhaust scrubbing.

A student of Reykjavik University conducted a feasibility study for the Icelandic fishing fleet [17]. It was concluded that switching to LNG would bring about significant environmental gain. NPV calculations were performed for conversions and newbuilds for different types of fishing vessels and six price scenarios. It was concluded that adopting gas fuel is always an environmentally sound choice. Economic feasibility depends on vessel type, use and fuel price developments.

The only study regarding cruise vessels was performed by DNV GL. They proposed retrofitting cruise ships to LNG by elongation [18]. It is claimed to be feasible for many vessels. It does mitigate many of the problems associated with adopting the new fuel, such as expanded machinery space and extensive building time. Taking into account additional revenue from added cabins, breakeven can be reached in 4 to 8 years. However the many issues associated with cutting a ship in half may make the project unfeasible and a detailed ship-specific analysis is required. This analysis was also performed at a time where the LNG/HFO price gap was much more favorable.

## **2.3 Academic research**

Industry participants have been more active in publishing their research on the matter. Very few academic papers exist on LNG machinery systems, excluding LNG carriers. The industry papers come in the form of semi-marketing research papers or presentations. The data referenced is not available for independent analysis and is thus rightfully subject to skepticism. Utilizing also information published by their competitors, a range of possible real results can be determined.

The main reciprocating gas and dual-fuel engine solutions have been compared for ferries [19]. The paper was also motivated by the lack of specific solutions for complying with the IMO Energy Efficiency Design Index (EEDI) and The International Convention for the Prevention of Pollution from Ships (MARPOL). EEDI values and plant efficiency was calculated to find acceptable machinery solutions. It was concluded that, despite higher initial cost, LNG machinery had merit due to lower operational expenditures. Yet the analysis is incomplete – the authors did not account for lost cargo space.

The cost benefits of adopting LNG are largely determined by the percentage of time the vessel spends in an ECA [20]. Through statistical analysis, it was found that handy size tankers and medium ferries have most to gain with payback times of 3 to 8 years. Whereas those vessels spend around 80% of their time in an ECA, large cruise vessels spend only 32%.

## **2.4 Industry research**

Industry-published research has a tendency to be skewed towards promoting certain products. Nevertheless they often provide insight which would otherwise be inaccessible.

ABB Turbo Systems performed a study to improve the tradeoff between efficiency and NOx emissions common to gas and dual fuel engines [21]. It was found that two-stage turbocharging and variable valve timing can offer significant improvements.

Wärtsilä presented a case study where they calculated how quickly the extra investment in an LNG powered multipurpose vessel would pay off. It was found that when operating 100% in an ECA, the breakeven was 3.4 years whereas when operating only 60% in an ECA, the breakeven was in 7.4 years. It is stressed that the results are highly dependent on the vessel's operating profile and local fuel prices [22].

## **2.5 Books**

Many books have been published on LNG yet very few of them contain useful information on its application in marine machinery systems. Most published literature either concentrates on carbohydrate exploration, its large scale treatment or utilization in land-based power plants. When the marine sector is covered, it is often merely a page or two on LNG carriers. Yet when

looking at the larger picture, there are books which can aid in understanding the current developments.

The reasoning behind the continued domination of Diesel and Otto cycle engines is described in “Prime Movers of Globalization: The History and Impact of Diesel Engines and Gas Turbines” by Vaclav Smil [23]. According to the author there are no serious competitors to the engines and these will continue to dominate due to high thermal efficiency and market inertia. The book provides terrific insight for assessing the disruptive potential of fuel cells or other alternative technologies.

The book “LNG bunkering” was published in 2013 [24]. It does not go into much depth, being only 100 pages, but it does provide a good overview of the technical and commercial considerations of fueling ships with LNG. It not only describes the main components and characteristics of LNG bunkering machinery but also storage, training, regulations and possible problem areas. The book is a very welcome addition to the literature concerning marine use of LNG. It serves as a very approachable overview on a seldom overly abstracted area.

## **2.6 Conclusion**

A wealth of literature has been published on gas-fueled transport solutions. Yet for shipowners contemplating a move to this new fuel, a large barrier still exists. Most publications concern only the macro such as trends, legislation and infrastructure development. Such information, although informative, is not directly applicable. It also becomes apparent that the field is complex and still under rapid development, causing further confusion. In such situations, case studies offer a necessary bridge between research and industry. Currently none have been published on LNG cruise ship solutions. The author aims to mend this.

## 3 Drivers of change

Researchers at DNV GL identified strict emission requirements and the relatively low cost of gas as the primary drivers for adopting LNG [3]. This chapter aims to study and expand on this train of thought.

### 3.1 Air pollution regulations

Marine transport is a heavily regulated and highly competitive industry. Regulation and enforcement are required for industry participants to risk adopting new and often expensive solutions. Ship emissions are regulated on international, regional, national and local level. The current subchapter focuses on primary regulations which a newbuild cruise ship is expected to meet when operating in the Mediterranean, North American and Caribbean area.

#### 3.1.1 International regulations

In international marine transport, these requirements are set by the IMO Marine Environment Protection Committee (MEPC). MARPOL applies to all ships conducting international trade. Annex VI of this document, titled Prevention of Air Pollution from Ships, is the focus of our interest [25]. It sets limits to ship emissions globally and also locally in emission control areas (ECAs).

##### 3.1.1.1 GHG emission regulations

Of the various greenhouse gases that marine fuel combustion produces, only carbon dioxide is regulated. EEDI is a measure of CO<sub>2</sub> emitted per unit of transport work. It applies only to newbuilds and provides incentive for the industry to move towards less wasteful solutions [26] [27]. Most influential factors include installed power, efficiency of fuel utilization and fuel carbon content. Slower cruising, waste heat recovery and utilizing alternative fuels are all promising methods for meeting new EEDI limits.

IMO MEPC in April 2014 announced that cruise vessels utilizing non-conventional propulsion (such as diesel-electric or gas turbine) would also be required to comply with EEDI [27]. The amendment entered into force on January 1, 2015 requiring a 5% CO<sub>2</sub> emission reduction for large cruise ships. From 2020 onwards the reduction must be 20% and from 2025 onwards 30% compared to a benchmark reflective of the global fleet efficiency in 2013. A major shift towards greater efficiency is underway.

##### 3.1.1.2 SO<sub>x</sub> and PM emission regulations

MARPOL Annex VI Regulation 14 requires progressive reduction of Sulphur content in marine fuels. Starting 1<sup>st</sup> of January 2020 (or 2025 if so decided), all ships are required to burn fuel containing at most 0.5% Sulphur or utilize emission control methods to achieve equivalent emissions. In ECAs the limit is set at 0.1%.

### 3.1.1.3 NOx emission regulations

MARPOL Annex VI Regulation 13 requires the engines installed on newbuilds to adhere to Tier II requirements - essentially a 20% reduction in NOx emissions. When operating in NOx ECAs, which the North American and U.S. Caribbean ECAs are, the engines must meet Tier III requirements. The latter requires approximately an 80% reduction in NOx emissions from levels that applied to ships built in the years 2000 to 2011 [28].

### 3.1.1.4 Emission control areas

For the purposes of our study, we must consider both current and possible future ECAs. U.S. coastal waters and some areas in the Caribbean Sea are already under strict emission control. New ECAs in the Gulf of Mexico [29], the Mediterranean Sea [3] [30] and many others (presented in Table 1) are currently under consideration. ECAs in our prospective operational areas have been presented in Figure 1 and Figure 2.

**Table 1: In-force and possible future ECAs**

*Source: adapted from [31]*

<b>In-force ECAs</b>	<b>Future ECAs</b>	<b>ECAs under consideration</b>
United States Caribbean Sea (SOx, NOx, PM)	EU coastal waters (SOx starting 2020)	Mediterranean Sea
North America (SOx, NOx, PM)		Turkish Straits
Baltic Sea (SOx only)		Norway
North Sea (SOx only)		Singapore
		Hong Kong / Guangdong
		Australia
		Japan
		Mexico
		North Sea (NOx)

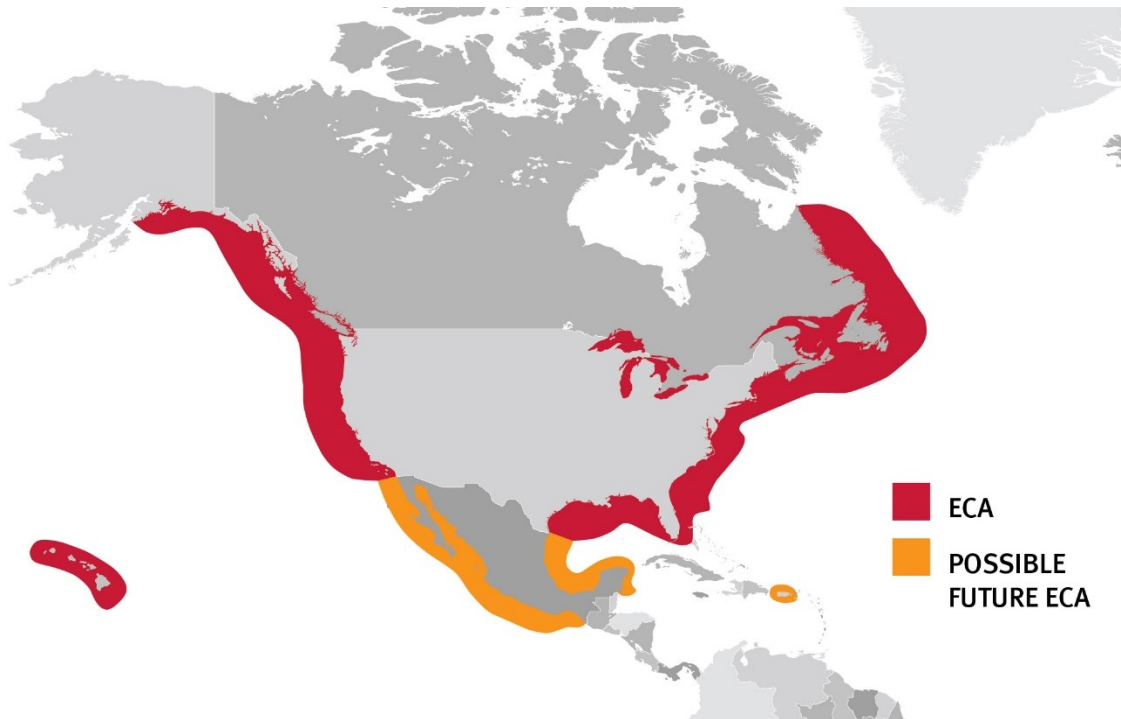

**Figure 1: Emission control areas in the Americas**

*Source: Adapted from [30]*

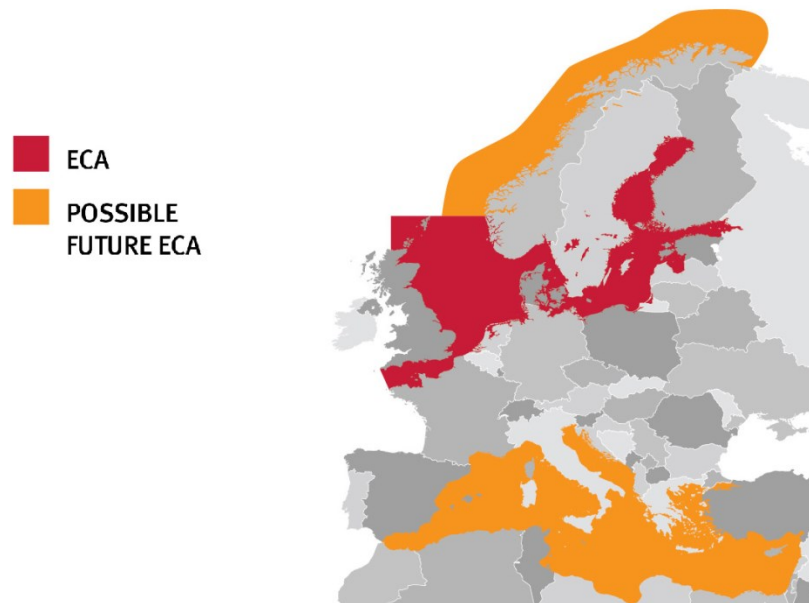

**Figure 2: Emission control areas in Europe**

*Source: Adapted from [30]*

### 3.1.2 Regulations in the United States

The U.S. Environmental Protection Agency (EPA) has developed regulations similar to MARPOL Annex VI to be enforced on vessels operating in U.S. waters. The “Control of Emissions from New Marine Compression-Ignition Engines at or Above 30 Liters per Cylinder” took effect in 2010. The rule differs from Annex VI primarily in three ways. Firstly, it categorizes engines not based on speed but rather cylinder volume. Secondly, unlike Annex VI, it requires engine manufacturers to measure particle matter (PM) emissions when operating on distillate fuel. Finally, the regulation introduces limits to hydrocarbon and carbon monoxide emissions [31].

IMO and EPA NOx requirements are to a large extent equivalent. It is though mandated that Category 1 and 2 engines (those of up to 30 liters displacement per cylinder) use diesel containing less than 0.0015% Sulphur. Furthermore the hydrocarbon (HC) and carbon monoxide (CO) emissions must remain below 2.0 and 5.0 g/kWh respectively. Category 1 or 2 engines operating extensively outside U.S. waters are often exempt from meeting EPA requirements provided those of IMO are met [31].

### 3.1.3 Regulations in the European Union

In addition to ECAs, all ships berthing in EU ports and operating on inland waterways are limited to using fuel of up to 0.1% Sulphur. Additionally starting 2020 all vessels operating in EU waters must do so with 0.5% Sulphur fuel or equivalent.

### 3.1.4 Conclusion

Clearly the current direction in marine transport is towards cleaner air and cleaner fuels. Table 2 contains information restrictions to come into force in the next 10 years.

**Table 2: Emission limits**

*Source: adapted from [31]*

	'16	'17	'18	'19	'20	'21	'22	'23	'24	'25	...	
SOx (Global)	3.5% max S in fuel				0.5% max S in fuel							
SOx (ECA)	0.1% max S in fuel											
NOx (Global)	Tier II (20% reduction in emission from Tier I)											
NOx (ECA)	Tier III (80% reduction in emission from Tier I)											
CO2 (Global)	10% reduction				20% reduction				30% reduction			

Due to these current requirements LNG is already competitive with conventional fuels. Considering also possible future restrictions on the abovementioned or other pollutants, it is in the ship-owner’s best interest to adopt a cleaner solution. How can burning natural gas aid us in reaching these goals? The attainable benefits are combined in Table 3.



**Table 3: LNG emission benefit**

*Source: adapted from [3]*

<b>Emission component</b>	<b>Reduction with LNG</b>	<b>Comments</b>
SOx	99%	ECA and global compliant
NOx from 4-stroke engine	85%	Tier III compliant
NOx from 2-stroke engine	40%	Tier III compliant after exhaust gas treatment
CO2	25–30%	Benefit for EEDI compliance
GHG in CO2 equivalent	0-30%	No regulations (yet)
Particulate matter	95-100%	No regulations (yet)

### **3.2 Effluents**

Just as gaseous emissions are regulated, so are the liquid byproducts of scrubber operation – sludge and wash water. Sludge, a dense mix of combustion byproducts, must be stored onboard until it can be safely transferred to a sludge handling facility ashore.

Washwater can be released into the sea provided certain requirements are met. IMO “2009 Guidelines for Exhaust Gas Cleaning Systems” provides limits for effluent acidity, turbidity, temperature and concentration of polycyclic aromatic hydrocarbons (PAH) and nitrates [31].

Washwater discharged within three nautical miles from the U.S. coastline must comply with the EPA Vessel General Permit (VGP). The regulation effectively renders open-loop scrubber use impractical [31].

### **3.3 Economics of LNG**

When assessing the financial viability of LNG as fuel, two major items must be considered – the costs of fuel and those of machinery. Although the latter seems more expensive, its costs are well amortized over the ship’s lifespan. The cost of fuel remains a major issue. The operational costs must remain below those of a scrubber installation and those of burning low Sulphur crude derivatives.

The aim of this chapter is to reach a realistic estimate for the price of LNG in Miami. The author applies information gathered from industry sources as to the current pricing methods and costs of relevant components. A price comparison of LNG and conventional marine fuels is presented. No attempt is made to predict future prices.

#### **3.3.1 Natural gas pricing models in North America**

Traditionally the price of natural gas as a commodity has been determined on an oil linked basis. With LNG is expected to become the second most valuable physical commodity by late 2015 [32], a transition to a more independent spot market price is underway. The standard gauge for

gas price in North America is published at the largest local gas trading hub, Henry Hub [33], situated in Louisiana. According to an industry source the current LNG bunkering contracts signed for operation in the Gulf of Mexico are so-called Henry Hub linked.

### 3.3.2 Estimates for LNG price in Miami

To arrive at a reasonable estimate for the price of LNG in Miami, multiple pricing methods of the Henry Hub (HH) linked pricing model have been utilized. The HH price used in the following calculations is 2.79 \$/MMBtu [34] (dollars per million British thermal units).

The first method is based on the claims of William M. Wicker, CEO of Venture Global LNG - a U.S.-based LNG production and export company. Including delivery to Asia 8.14 – 8.89 \$/MMBtu is attainable at HH price of 2.511 \$/MMBtu [35]. Transport costs are estimated at 3 \$/MMBtu and liquefaction at 2.25 – 3 \$/MMBtu. With the current HH price he would most likely quote a price range of 8.42 – 9.17 \$/MMBtu. Estimating that the additional delivery cost would roughly equal the cost of a bunkering service in Miami, we arrive at 8.8 \$/MMBtu.

In the second method it is assumed that gas is transported to Miami by pipeline. To find the cost of natural gas at our chosen destination, the Florida Citygate price [36] is utilized. Charting this price along with HH, we can conclude that the added cost of pipeline transport is roughly 0.74 \$/MMBtu with 95% correlation to HH price. By adding a rather pessimistic 4 \$/MMBtu for liquefaction (due to low volume) and a 20% markup for distribution we arrive at 9.0 \$/MMBtu.

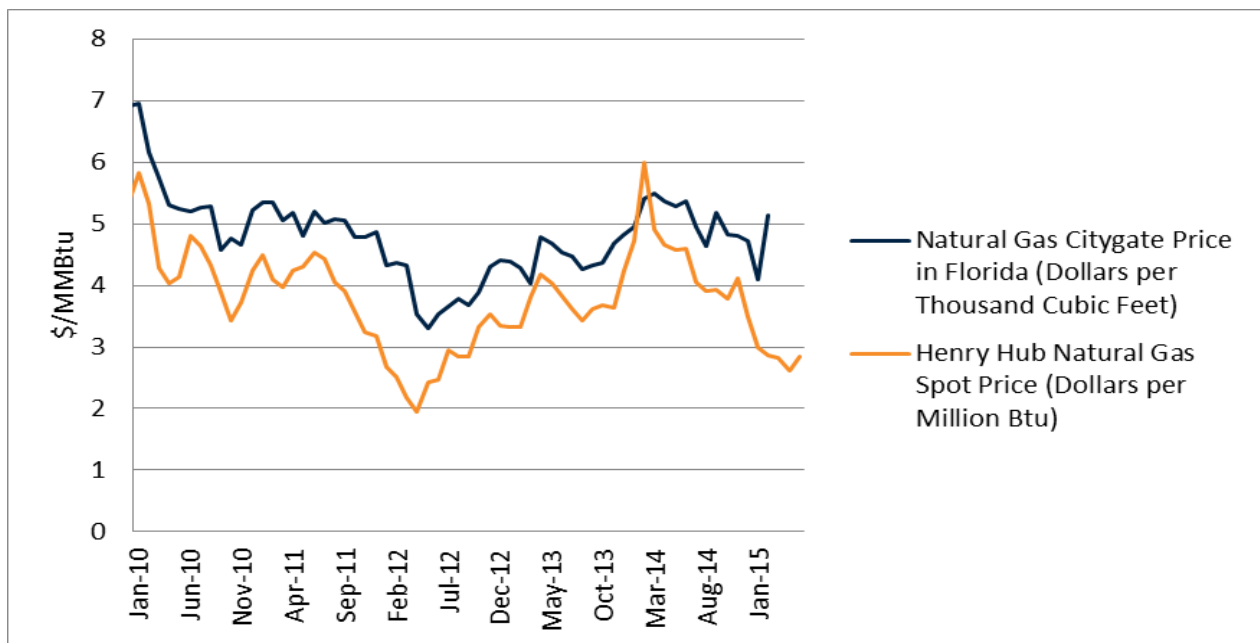

**Figure 3: Citygate price**

Source: EIA [36]

A further price point by David Schultz from LNG America:

*Regarding pricing at today's Henry Hub Price a number in the \$13 to \$14 USD per MMBtu delivered in South Florida at 2,000 m3 once a week is a good budgetary number for the first vessel. As the number of vessels or bunkering events increase to a high utilization rate on the bunker barge or shore based facility you could expect that number to drop to the high single digits - \$9 +/- per MMBtu.*

### 3.3.3 Cost of alternative fuels

Adoption of LNG is to a large extent dependent on the costs of currently used fuels such as 380-centristroke intermediate fuel oil (IFO380) or 0.1% sulfur marine gas oil (0.1%S MGO). Prices of these fuels have been presented in Table 4.

**Table 4: Cost of marine fuels**

	<b>LNG</b>	<b>0.1%S MGO</b>	<b>IFO380</b>
<b>Specific energy (MMBtu/ton)</b>	47.3	39.8	38.3
<b>Current price (\$/ton) [37]</b>	426	481	272
<b>Current energy equivalent price (\$/MMBtu)</b>	9.0 (Miami)	12.1	7.1

As can be seen, LNG is currently cheaper than MGO but more costly than IFO380.

Applying again the assumptions made in the second method, the hypothetical LNG price throughout the last five years has been presented below and compared with the West Texas Intermediate (WTI) crude index (which is roughly equal to the price of IFO380). It can be noted that for the first time in these five years, LNG is near price parity with fuel oil.

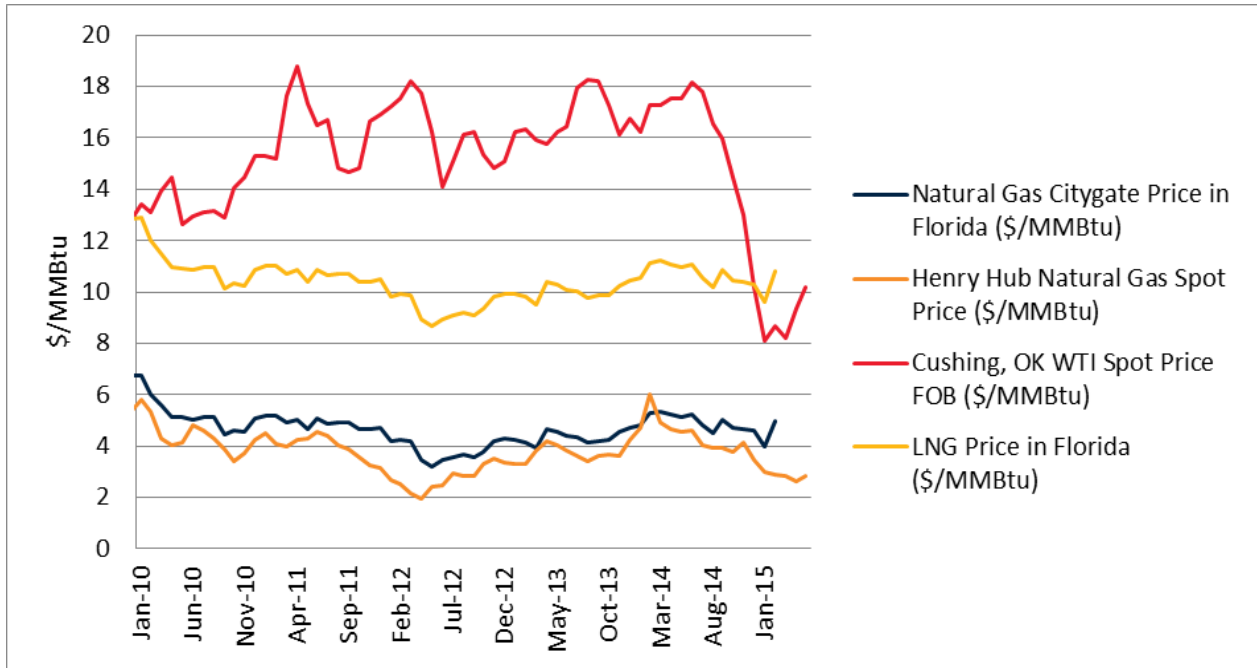
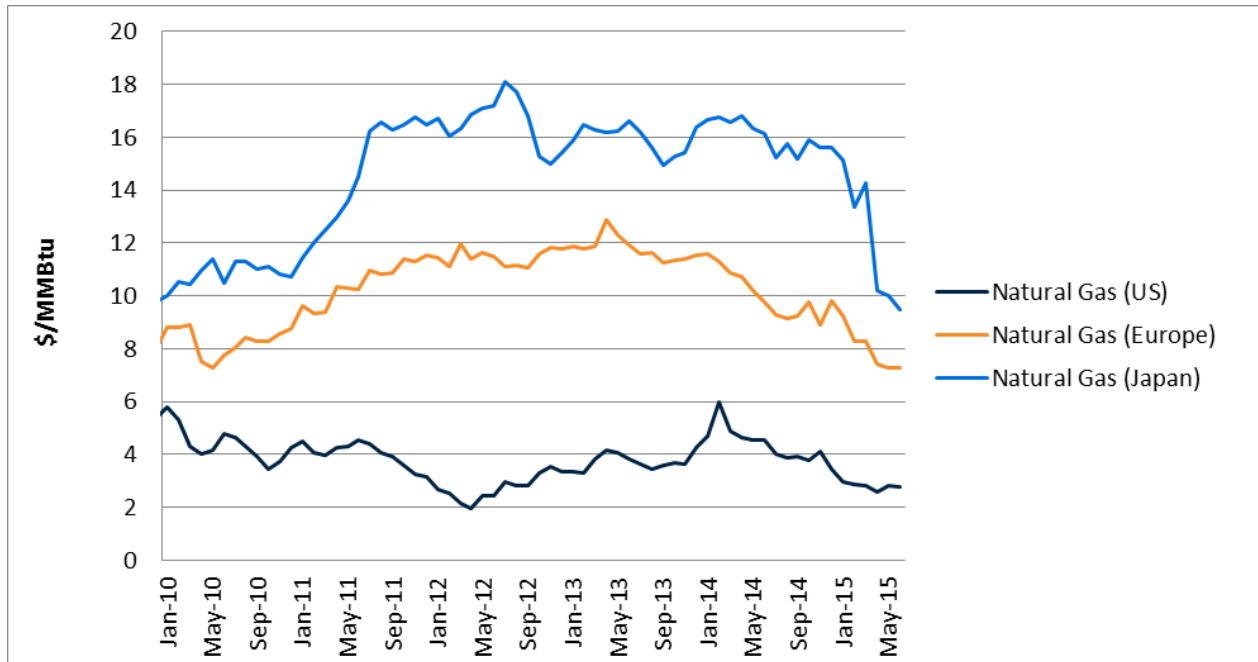

**Figure 4: Fuel price comparison**

*Source: EIA [34]*

### 3.3.4 Global LNG prices

Comparison between the monthly prices in U.S. Henry Hub, European Gate terminal and the LNG import price in Japan is provided in Figure 5. It must be noted the prices vary significantly between these regions and any price for LNG is only valid locally.



**Figure 5: Price of gas among regions**

*Source: World Bank [38]*

9 \$/MMBtu appears to be a solid lower estimate for the price of LNG. Yet as the bunkering service is still developing, some key players may have a different understanding of the risks involved and insist on higher margins. Such changes may easily raise the price to 10 or 11 \$/MMBtu. It must also be noted that LNG price is largely uncorrelated with that of crude oil and differs significantly between geographical regions. Independent cost analysis should always be performed.

### 3.4 Conclusion

New emissions regulations have been set in place both globally and locally. Strict rules now govern the maximum amount of Sulphur and Nitrogen oxides as well as many other components. These rules are certain to remain in place and more are likely to follow. LNG is a real alternative. It offers an elegant way to achieve emission reduction. The economics of the fuel are dependent on the future of natural gas and crude oil pricing. Any such decision should be postponed until fuel prices are stabilized. Current 10% daily fluctuations do not provide solid foundation for making such plans. The conditions required to make LNG clearly economically feasible are presented in Chapter 5.

## 4 Options

The aim of this chapter is to provide an overview of technologies which can assist the ship-owner to the abovementioned environmental criteria in the most cost-effective manner. The conventional choices such as exhaust scrubbing and burning low Sulphur fuel as well as more innovative solutions such as fuel cells are considered.

### 4.1 Conventional options

Today 97% of seagoing vessels are powered by diesel engines [39]. The main advantages are low specific fuel consumption (SFC) and the abundance of cheap fuel. Secondary benefits are high specific energy of diesel fuels and the relatively small cost of the engines.

Three conventional options exist for a diesel engine vessel to meet new emissions guidelines. The engine can be fitted with exhaust cleaning machinery, converted for the use of distilled crude products or for dual fuel combustion. The benefits and drawback of these options have been presented in Table 5.

**Table 5: Compliance options**

*Source: adapted from [31]*

Assuming operation year 2020 or later

	<b>Fuel oil switching</b>	<b>Conversion to distillate only</b>	<b>Conversion to natural gas</b>	<b>Exhaust gas cleaning</b>
<b>ECA operations</b>	Burn 0.1% Sulphur fuel	Burn distillate	Burn natural gas	Burn high Sulphur fuel; Scrubber ON
<b>Non-ECA operations</b>	Burn 0.5% Sulphur fuel	Burn distillate	Burn natural gas	Burn high Sulphur fuel; Scrubber OFF
<b>Advantages</b>	Low cost fuel in non-regulated areas	Simplified fuel and waste operations	Low cost fuel in all areas Clean burning	Low cost fuel on all areas
<b>Challenges</b>	High fuel cost in ECAs; Risks inherent with fuel switching	High fuel cost	High capital cost; Complex gas handling logistics	Complex operations; High capital cost; Waste/chemical management

## **4.2 Unconventional options**

Gas turbines in combined operation with heat recovery systems can reach efficiencies of up to 60% [40]. These plants offer low emissions as well as good vibration and noise characteristics. Yet as distilled fuels or gas need to be always used, the operational costs have remained relatively high. With the advancements in gas bunkering infrastructure and the adoption of cleaner fuels, the gas turbine may finally become competitive.

Similar efficiency and fewer emissions can be achieved through the use of fuel cells. Units operating on hydrogen and oxygen have been installed on four German submarines. Not due to their high efficiency but rather their low noise and temperature signature. The installation costs were estimated in 2011 to be 20 times higher than the diesel equivalent. Currently this technology is not a real alternative for economically driven projects.

Coal as well has been considered as an alternative fuel for it is the cheapest source of energy. Coal reserves are currently at over 200 times the annual consumption compared to 40 years for gas and 60 for oil. But the fuel has significant downsides. Coal combustion produces a great deal of residue and the combustion chamber requires frequent overhaul. Furthermore the exhaust gases would still need to be cleaned of excess SO<sub>x</sub>. Overall the increased maintenance requirement outweighs any potential cost savings.

Nuclear power, technologically viable and providing an escape from fossil fuels, remains largely unutilized as most ports would not permit such vessels entry. These ports do not have required safety protocols to handle the fuels and any incidents that might occur. Likely, even if these did exist, there would be significant public opposition. Nuclear power should first be proven viable in other marine applications before being introduced on cruise vessels.

Solar and wind, the conventional renewable energy sources, do as of yet not provide sufficient power to be considered prime mover technology, but can offer significant fuel savings. Solar panels have been installed on many cruise ships and the “sky sail” technology can provide up to 2 MW of propulsive power in good wind conditions. WESSELS Reederei GmbH, which has installed these on two of their vessels, reports annual average fuel savings of 10 to 15% [41]. These sources merit attention but lay outside the scope of this study.

## **4.3 LNG as the new marine fuel**

Liquid natural gas is sometimes considered a conventional fuel, as it has been widely used in land-based power plants. Yet it can also be considered an outsider as it is rather novel in marine applications. In order for it to be suitable for marine use, a fuel must strike a good balance between price, energy density, specific weight, safety and global availability. The aspect of price was covered in a preceding chapter and will again be studied in the case study. The current chapter aims to assess the suitability of LNG in all remaining abovementioned aspects.

#### 4.3.1 What is LNG

Natural gas (NG) and LNG are both mixtures of methane and other substances (presented in Table 6). The ratios of these vary by gas source and treatment. LNG has a higher heating value than NG kg/kg because many of the non-combustible components have been removed in the process of liquefaction. Whereas NG is commonly around 82%, LNG is 95% methane. As ship fuel LNG can help significantly reduce the environmental impacts of shipping.

**Table 6: LNG composition**

*Source: adapted from [42]*

Component	Typical LNG
Methane (CH <sub>4</sub> )	85 - 90 %
Ethane (C <sub>2</sub> H <sub>4</sub> )	3 - 8 %
Propane (C <sub>3</sub> H <sub>8</sub> )	1 - 3 %
Butane (C <sub>4</sub> H <sub>10</sub> )	1 - 2 %
Nitrogen (N <sub>2</sub> )	0 - 2 %

#### 4.3.2 Energy density

For cruise ships must commonly be self-sufficient for many days at a time, energy density of fuel plays an important role. High values signify that more space could be used for cabins and other revenue-creating areas. As can be noted from Table 7, a liter of LNG contains significantly less energy than an equivalent volume of diesel. It is nevertheless the best of the available clean solutions. A liter of hydrogen contains only a quarter of the energy of a liter of diesel and the alcohols suffer from production scalability issues. Liquefied petroleum gas (LPG) due to its longer carbon chains emits more CO<sub>2</sub> and compressed natural gas (CNG) is only feasible for small scale applications.

**Table 7: Fuel energy density**

*Source: adapted from [43]*

Fuel	Energy density, GJ/m <sup>3</sup>
<b>HFO</b>	<b>41.20</b>
<b>MGO</b>	<b>35.68</b>
Biodiesel (E20)	32.61
Gasoline	30.38
LPG	23.41
Ethanol (E85)	22.30
<b>LNG</b>	<b>20.49</b>
Methanol (M85)	15.61
CNG	9.20
Liquefied hydrogen	8.50



### 4.3.3 Safety

LNG is safer than other commonly used hydrocarbons. It is non-toxic and has a very narrow flammability range – only 5% to 15% mixtures are prone to combustion. Its primary hazards are freezing damage due to its extremely low temperature and asphyxiation danger due to being an odorless and around 1.5 times heavier than air at boiling temperature. However as the gas temperature rises, it becomes lighter than air and quickly dissipates [44].

### 4.3.4 Availability

Tomas Aminoff, Wärtsilä Director of Technology Strategy, sees LNG becoming available in Miami with bunkering being allowed in ports while crew and passengers remain onboard [45]. Such operations require a formal operational risk assessment to be performed [8].

### 4.3.5 Current fleet and orderbook

As of July 2015 there were 65 LNG fueled ships in operation worldwide [46] excluding LNG carriers and inland waterway vessels. 81% of these are operating in Norway. There are 79 confirmed LNG fueled newbuilds, most in America and Europe. Although the fleet is growing rapidly, it is currently below the growth speed previously estimated by DNV GL. In 2015 the first ever LNG-fueled cruise vessels were ordered by Carnival Corporation. Likely others will follow.

## 4.4 LNG-compatible prime movers

LNG can be utilized by three types of reciprocating engines as well as by gas turbines. The current chapter focuses on identifying which of these designs are best suitable for our application.

### 4.4.1 Gas turbines

Gas turbines have a troubled history in cruise ship applications. During the 2000s they were installed on many vessels. Yet as soon as fuel prices started to rise, the characteristic problems of turbines began to outweigh their benefits. In light of recent technological and operational advancements, perhaps this technology deserves a second chance.

The General Electric (GE) LM2500 series aeroderivative models are by far the most popular and have been installed on 21 ships. The thermal efficiency of that model is 38% [47] - low compared to 48% for medium speed large bore dual fuel engines. In combined cycle with secondary turbines the total efficiency can greatly be increased. The high temperature exhaust gases are used as input for the secondary turbine which captures heat energy that would have otherwise been lost. Measured efficiency has been as high as 60% [40]. Turbines commonly suffer from unfavorable efficiency at partial loads when compared to diesel engines.

Gas turbines can also be designed to use any predefined ratio of gas/fuel mixture. They commonly provide reduced vibrations and cleaner exhaust gas compared to diesel engines. So

far there has been very little financial incentive to use the technology as it requires 15% - 20% more capital expenditure (CAPEX) and is limited to using expensive high purity fuels [47] [48] [39]. The turbine can be run on natural gas, biodiesel (BD) and MGO. The reduced weight and size allows for more flexible placement which can create space for tens of new cabins, possibly offsetting its additional costs.

#### 4.4.2 Two-stroke gas-diesel engines

The most efficient marine engines have always been of the 2-stroke diesel type. Now Gas-diesel engines have been developed based on the same design, to run on various gas and diesel mixtures. In these engines, gas is injected into the combustion chamber at very high pressure just before combustion. NO<sub>x</sub> emissions are higher from these engines compared to lean-burn and dual-fuel engines. The gas-diesel engine does not therefore comply with IMO Tier III regulations.

According to a study led by ClassNK, the advantages of the design were high efficiency, stable combustion and very little methane slip. The primary challenges were caused by the 300 bar fuel gas supply system, which is prone to leaks and other problems [49].

The direct drive diesel setup, where a shaft generator is used to cover electricity needs, is commonly the preferred option. Auxiliary engines would be required to fill the gaps between power supply and demand. Furthermore, exhaust treatment systems such as exhaust gas recirculation (EGR) or selective catalytic reduction (SCR) would be necessary in order to meet Tier III emissions requirements [26].

#### 4.4.3 Four-stroke gas engines

These engines run only on gas. The extremely lean air-fuel mixtures lead to lower combustion temperatures and therefore reduced NO<sub>x</sub> formation. The engine operates according to the Otto cycle, with combustion triggered by spark-plug ignition. The gas is injected at low pressure. Though originally developed for land-based power generation, marine versions have been developed and installed in LNG-fueled ships operating in Norway.

As these engines are only capable of utilizing gas, for meeting Safe Return to Port (SRtP) requirements, a second backup fuel system (including tank) is required. Furthermore the route must be planned according to suitable bunker terminals and the operator will be unable to benefit from potential low diesel prices (as he could with a dual-fuel engine).

#### 4.4.4 Four-stroke dual-fuel engines

These engines can run in either gas or diesel mode. These engines as well work according to the lean-burn Otto principle in gas mode. Yet here the mixture is ignited by injection of a small amount of diesel fuel into the combustion chamber instead of by a spark plug. The injected diesel fuel is normally less than 1 % of total fuel. In diesel mode, the engine works according to the normal diesel cycle with diesel fuel injected at high pressure in the combustion chamber by a conventional injection pump. Here there is no gas admission but to ensure seamless transition

the pilot fuel is still injected into the chamber. This solution ensures that if gas or diesel supply were to stop, the engine could seamlessly revert to the other fuel. Either MGO or marine diesel oil (MDO) can be used.

#### 4.4.5 Suitable models

Cruise ships consume a large quantity of power. The most common option today utilized four to six medium speed diesel engines of the same bore and make. It has been found that such a configuration provides a good balance between ease of use and efficiency. Using multiple engines in parallel allows the operator to better adjust power supply to demand. As all prime movers have a certain range where they are most efficient, such a configuration increases system overall efficiency and reduces emissions. It is only reasonable that, four-stroke engines, very similar to the current industry standard, are becoming the norm for LNG as well. Below in Figure 6 the power ranges of available 4-stroke gas burning engines have been presented.

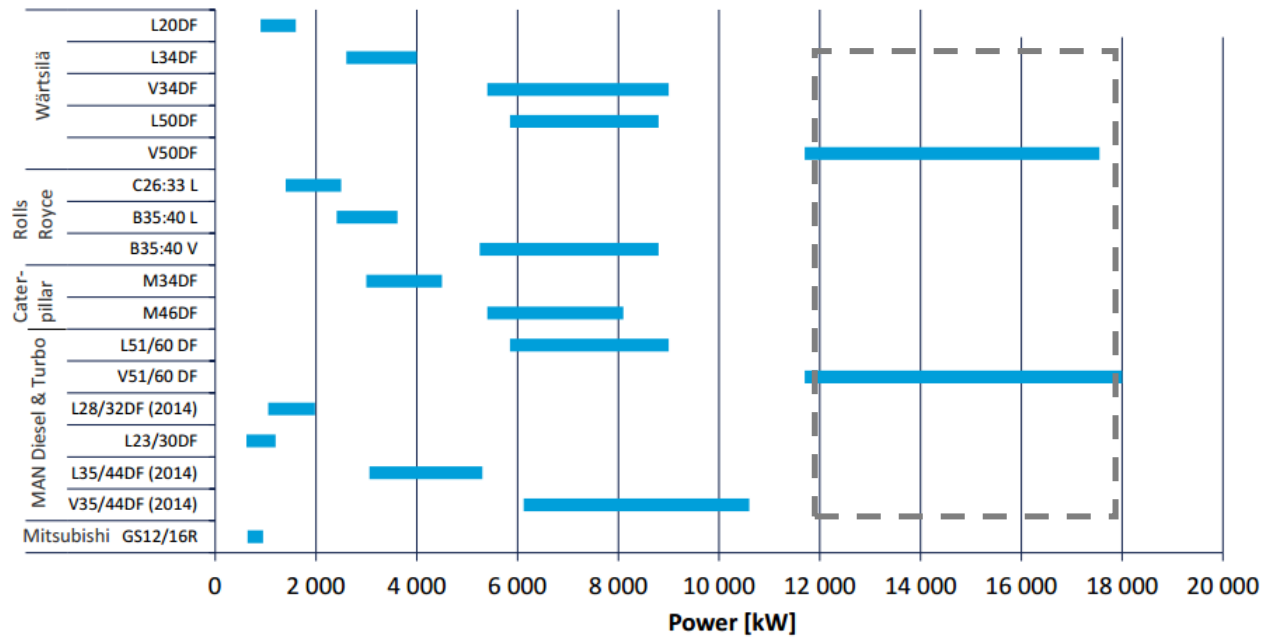

**Figure 6: 4-stroke gas engine product range**

*Source: adapted from [50]*

Assuming our vessel with four to six engines requires 72 000 kW of shaft power, a single unit would need to fall in the 12 000 to 18 000 kW range demonstrated with the grey dashed line. Only two four-stroke designs fall into this range. Both suitable designs are of dual-fuel type.

The only gas turbines to be considered are the LM2500+ series by GE as these have been well proven in marine applications.

Two stroke dual fuel engines were not considered due to their uneconomically large dimensions and operational characteristics.

#### 4.4.6 Current market situation

The current fleet has near equal representation of all major gas engine technologies – pure gas, dual-fuel and gas-diesel. Gas turbines have received little love. As can be seen in Figure 7, dual fuel (DF) will be the dominant technology for the near term

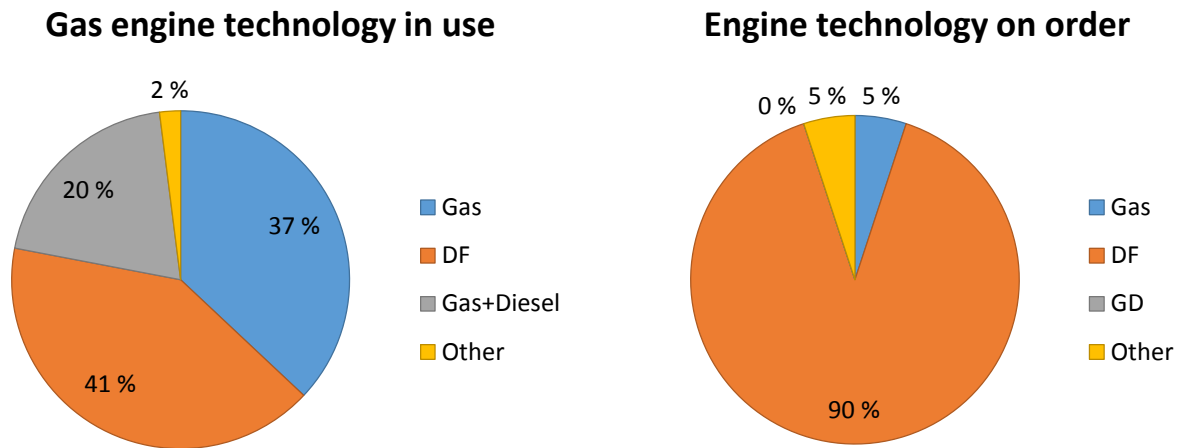

**Figure 7: Gas engine market**

*Source: adapted from [46]*

*Excluding gas carriers and inland waterway vessels*

#### 4.4.7 Conclusion

A comparison of the three major engine designs and the gas turbine has been composed and provided in Table 8. The large size of two stroke engines and the reduced fuel availability for pure gas engines were considered considerable flaws. Gas turbines and dual fuel 4-stroke engines shall be used in further calculations.

**Table 8: Pure gas and DF engine comparison**

*Source: adapted from [50], [51], [52] and [53]*

Type	4 stroke gas engine	4 stroke DF engine	2 stroke DF engine	Aeroderivative gas turbine
Ignition	Spark plug	Pilot oil		Spark plug
Pilot oil consumption	none	<1%	5%	none
Gas supply pressure	4-5 bar(g)	4-5 bar(g)	300 bar(g)	30-40 bar(g)
NOx Tier III	Meets	Meets on NG, BG	Meets using SCR/EGR	Meets on NG, BG
SOx ECA	Meets	Meets on MGO, MDO, NG		Meets on NG, BG, MGO
Methane slip	1-2%	1-2%	<1%	<1%
Fuel options	NG	NG, HFO, MGO, BD	NG, HFO, MGO, BD	NG, BD, MGO
LNG tanks required	≥2	1	1	1
Available products in cruise ship capacity	None	Wärtsilä: 46DF, 50DF MAN: 51/60 DF	MAN: ME-GI MHI: UEC-LSGi	GE: LM2500+ RR: MT30
Remarks	Knocking concern; Propulsion backup required	Knocking concern; high fuel consumption in fuel oil mode	High pressure system, Large size and weight.	High fuel consumption; Expensive

NG – natural gas

BG – biogas

BD – biodiesel

HFO – heavy fuel oil

SCR – selective catalytic reduction

EGR – exhaust gas recirculation

## 4.5 Exhaust gas treatment

Emission reduction goals can also be achieved by cleaning the exhaust gases. This chapter serves as an overview of the dominant technologies used to such end.

### 4.5.1 Scrubbers

Exhaust gas cleaning systems (EGCS), otherwise known as scrubbers, are designed for the removal of sulfur oxides to meet regulatory requirements. To date a total of 6 dry or membrane scrubbers have been installed compared to 160 wet scrubbers. High space requirement and weight renders dry scrubbers uneconomical. Membrane systems, on the other hand, have not yet been proven sufficiently reliable in large scale applications [31].

Three types of wet scrubbers are used – open cycle, closed cycle and hybrid. Open cycle scrubbers spray seawater into the exhaust flow to neutralize SO<sub>x</sub>. Closed cycle systems commonly utilize fresh water mixed with Sodium Hydroxide (NaOH). The third design is capable of operating in either mode. The resulting washwater is treated and then either recirculated or discharged [31]. Open loop operation has the lowest operating costs but is sensitive to regulatory limitations. Closed loop system can be used anywhere but require the resulting sludge to be stored onboard for the duration of the trip. In some areas designated by EPA, termed “No Discharge Zones”, even cleaned effluent may not be discharged [54]. The hybrid option, despite being most expensive of the three, remains most popular due to its flexibility [55].

### 4.5.2 Selective catalytic reduction

The emission of nitrous oxides is also regulated in many parts of the world. Selective catalytic reduction (SCR) reactors are commonly used to achieve compliance with the relevant limits. A liquid reactant such as ammonia or urea is injected into the gas flow where it binds NO<sub>x</sub> by chemical reaction. SCR or alternative NO<sub>x</sub> capturing technology is required to meet IMO Tier III or EPA Tier IV requirements when burning diesel fuel [31]. It is recommended for engines with up to 70 cm bore and is commonly installed downstream of four stroke medium speed engines [25].

### 4.5.3 Component placement

The placement of the economizers, SCR and scrubbing units is demonstrated in Figure 8. As SCR is only effective for high temperature (above 300°C [56] or 350°C [57]) gas, it must be positioned before the exhaust gas economizer. Wet scrubbers do not require hot gas and can therefore be positioned as the last component. It is only required that gas temperature be above dew point. Dry scrubbers on the other hand require the highest input gas temperature (240-450°C) [56] and must be placed before SCR and boiler units. This has caused problems as traditional SCR systems required low Sulphur flue gas [56]. However, most manufacturers now offer technologies able to withstand higher Sulphur content [57].

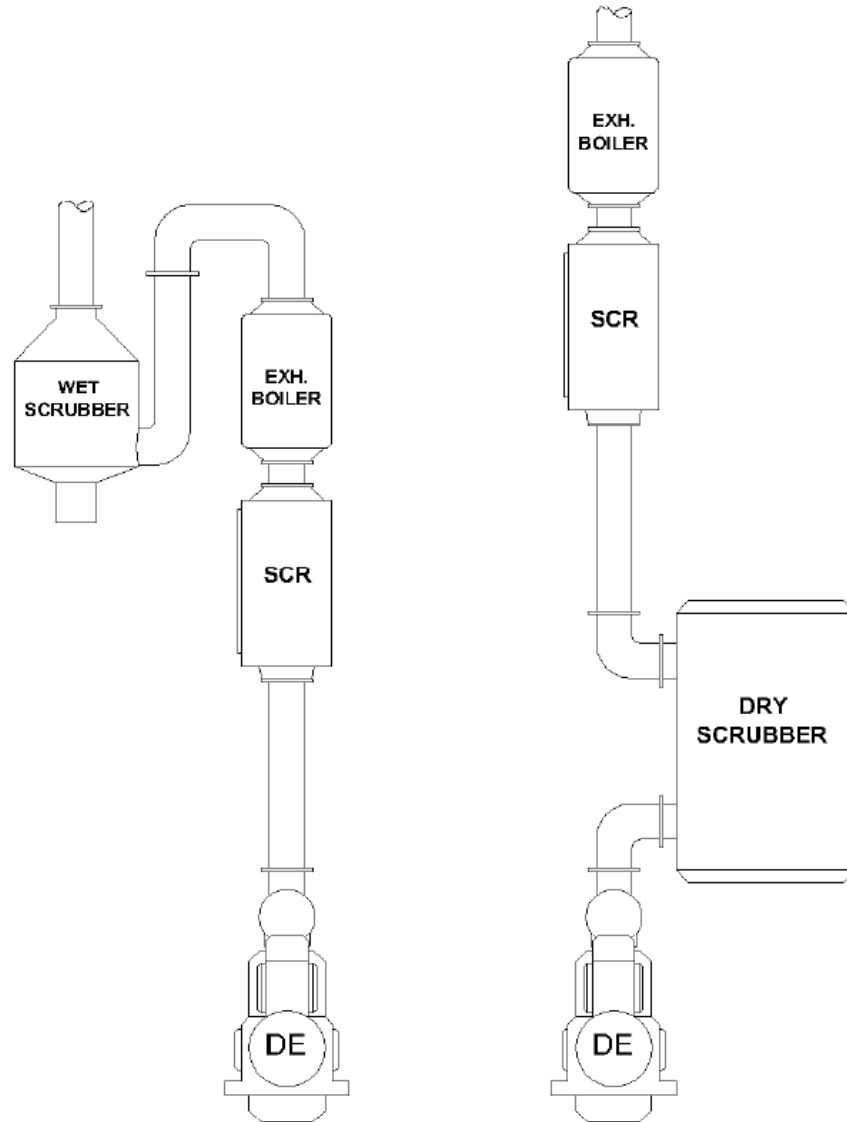

**Figure 8: Component placement**

*Source: adapted from [58]*

#### 4.5.4 Exhaust gas recirculation

Feeding a portion of the exhaust gas back into the combustion chamber lowers combustion temperature thereby reducing NO<sub>x</sub>. EGR has been used in automotive engines for many decades and is a mature technology [25]. EGR can reduce the emissions of a two stroke slow speed marine engine to Tier III levels (operating on either gas or liquid fuel) while increasing CO and PM emissions and reducing efficiency. It is the recommended option for cylinder bores 50 mm or larger [59] and is commonly installed on two stroke slow speed engines.

#### 4.5.5 Conclusion

Exhaust gas treatment systems are required today in many system configurations. Scrubbers are used for removing SO<sub>x</sub>. Wet scrubbers are much more widely used than dry or membrane systems. To achieve NO<sub>x</sub> limits, SCR is often used for four stroke engine configurations and EGR for two stroke systems.

### 4.6 Energy system concept

The average contemporary cruise ship is diesel-electric (DE). Mechanical power is produced by medium speed diesel engines and promptly converted to electricity. The DE power train is highly redundant as between four to six engines of the same model would commonly be installed. Any power could seamlessly be rerouted through the switchboard were it to be needed for safety, maintenance or efficiency reasons. The designs discussed in the thesis do not deviate far from this model.

Due to increasing emissions controls and the high prices of distillate marine fuels, the industry has long been considering dual-fuel solutions as a way to reduce price exposure to a single type of fuel and allow for more operational flexibility. The alternative fuel of choice is natural gas. Many changes must be made to the fuel system to ensure safe and efficient use of the fuel. Firstly, the most efficient way to store the gas is in liquid phase. This requires very efficient insulation and/or high pressure tolerance. Transporting the fuel to and from the tank is also more complicated as more insulation, special materials and forced ventilation are required. Furthermore, safety systems must be put in place to dispose of unwanted gas before its pressure increases to harmful levels. At first all effort is made to produce useful energy from the gas. If energy is not needed, the fuel is sent to a gas combustion unit. If that were to fail, the gas is vented to the atmosphere. Redundant fuel supply and ventilation systems must be put in place [51].

Figure 10 present a common diesel electric power plant configuration with electrical propulsion. This can be considered the standard concept on passenger vessels. Here electrical power is generated by 5 generators coupled to engines. These sets are distributed between two machinery rooms in order to ensure power availability in case of flooding. Two switchboards distribute the generated power between the consumers which can broadly be broken down to propulsion and hotel consumers. The electrical azimuthing propulsion units are positioned to the left-hand side of the drawing along with the required power conversion machinery.



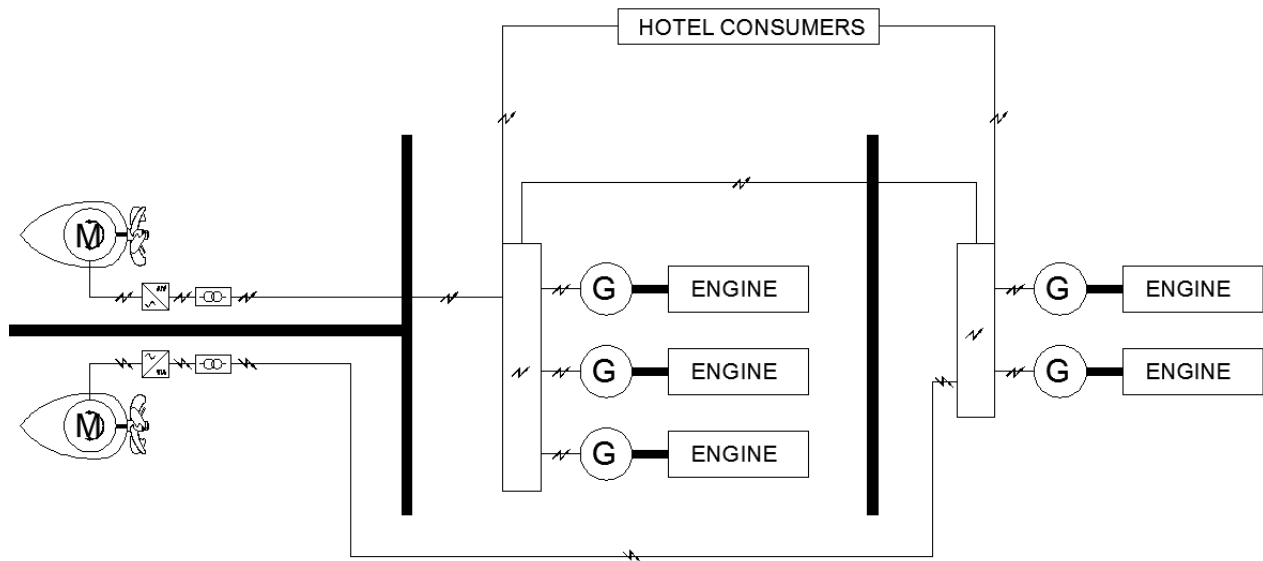

**Figure 9: Power plant type energy system**

In Figure 10 the independent fuel systems for MGO and LNG can be recognized. The former is marked with green and the latter with a distinct triple line marking the double-walled piping required for gaseous fuels. The LNG, after leaving the tank, is vaporized and heated to the required temperature in the conditioning unit (CU). It is then fed to the engines or the dual fuel boiler (DFB) through the gas valve unit (GVU). A small quantity of MGO is used as pilot fuel. In case the gas cannot be utilized, the fuel can be burned in the boiler or, as a last resort, vented to the atmosphere. Ship energy needs can alternatively be covered by MGO exclusively.

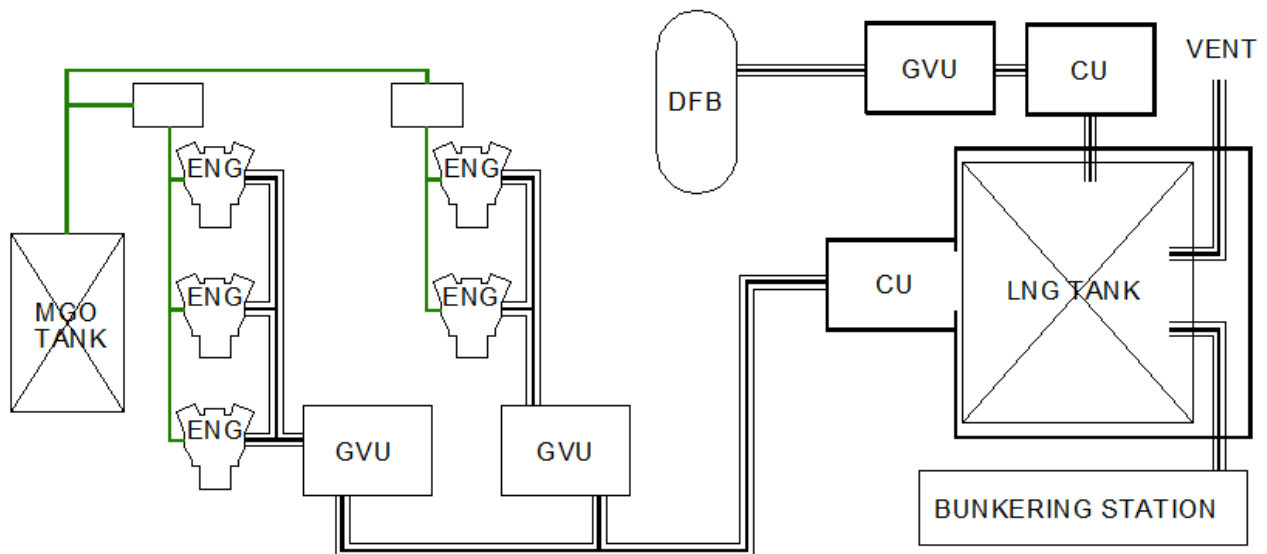

**Figure 10: Fuel handling system**

## 4.7 Fuel containment

The tanks that contain LNG comprise of a primary barrier, secondary barrier, thermal insulation and supporting structures. This aim of this chapter is to provide a brief overview of available designs and to conclude which of these are feasible for cruise ship use.

### 4.7.1 Tank types

These containment systems can either be of independent or integral nature. The former are completely self-supported and are considered independent of the ship hull. The latter transfer LNG loads to the ship's hull. All tanks types deemed fit by IMO for the carriage of LNG are presented in Figure 11. The tanks are, from top to bottom, described by the load-carrying approach, type according to the IMO IGF (and IGC) code, required secondary barrier, shape and more widely known manufacturers. For each of those tank types multiple producers exist and should be contacted if a project is to be undertaken.

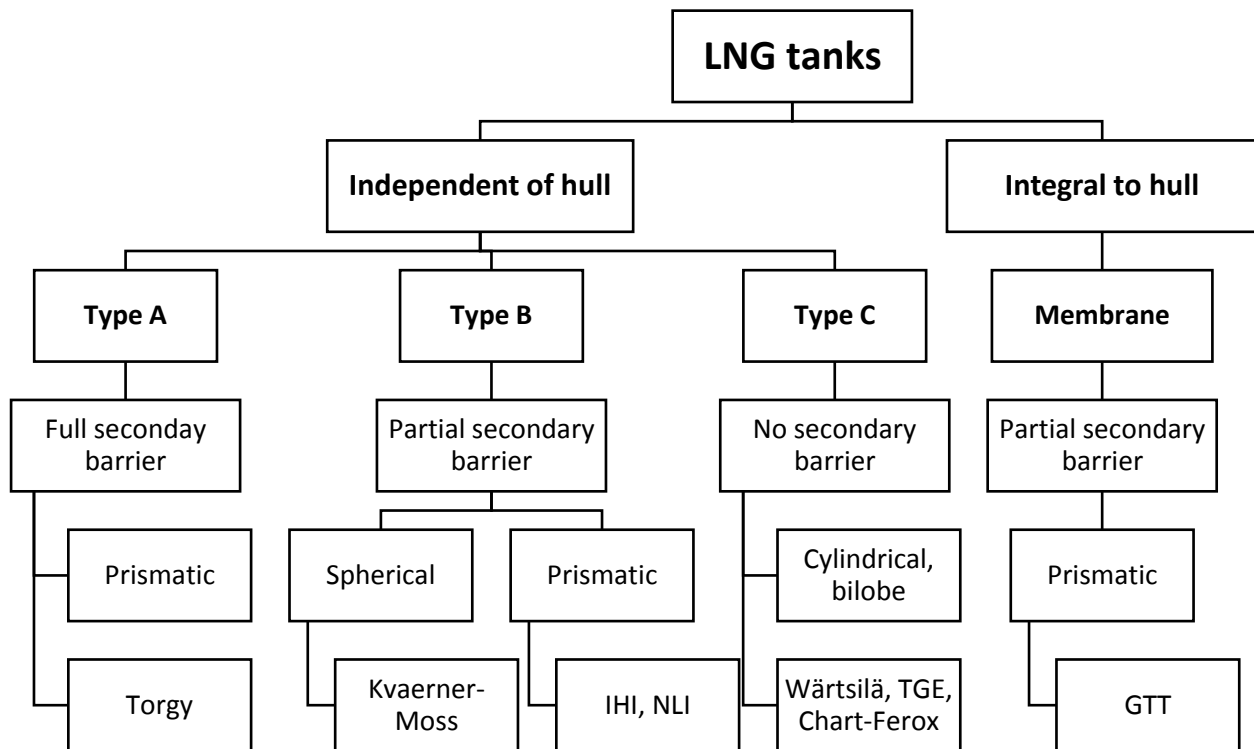
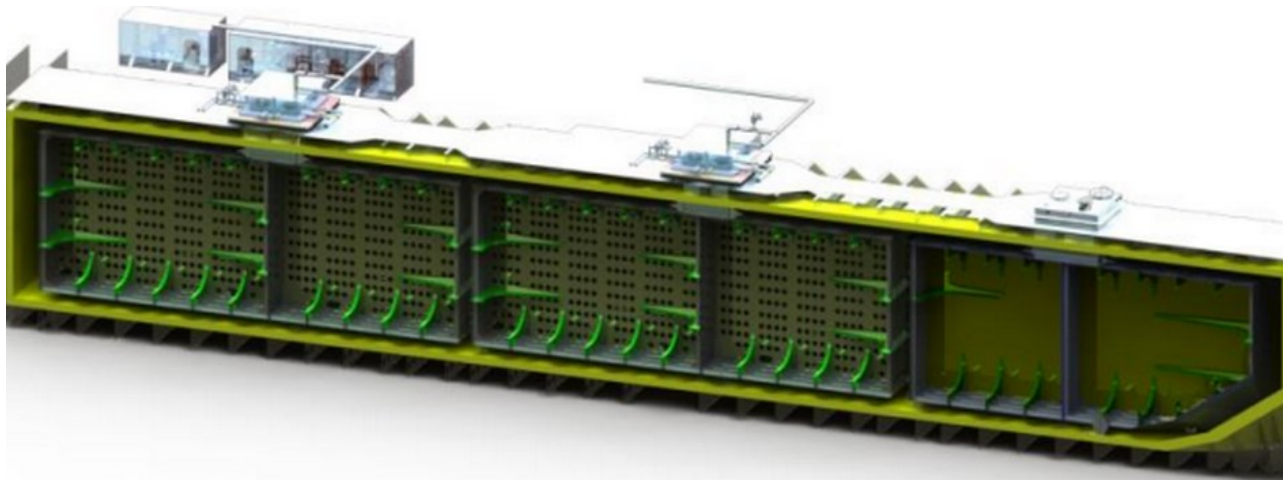

Figure 11: IMO tank types

#### 4.7.1.1 A-type

Tanks of this type were the first ever used for the carriage of LNG [60]. As can be seen from Figure 12, it offers reasonable space utilization. The design is not considered resistant to crack propagation and therefore requires a full secondary barrier constructed of low temperature-resistant steel. Though the hull may act as this secondary barrier, it is often uneconomical to build it out of stainless steel. The other option is to build a secondary barrier around each tank, increasing the size and weight of the arrangement. Type-A tanks are installed very rarely.



**Figure 12: LNG carrier with type A tanks**

*Source: Torgy [61]*

#### 4.7.1.2 B-type

The B-type tank is foremost a more economical version of the A-type as it does not require a full secondary barrier. Instead a low temperature-resistant drip tray below the tank is considered sufficient [62].

The most widely known B-type design is the Moss tank - the characteristic spherical tank of the 1970s LNG carrier (Figure 13). By now the Moss type tanks design has a long history of reliability [63]. The spherical aluminum shell is inherently safe and simple to inspect. In the last few years this design has been phased out as prismatic tanks are preferred due to their lower cost and higher space utilization.

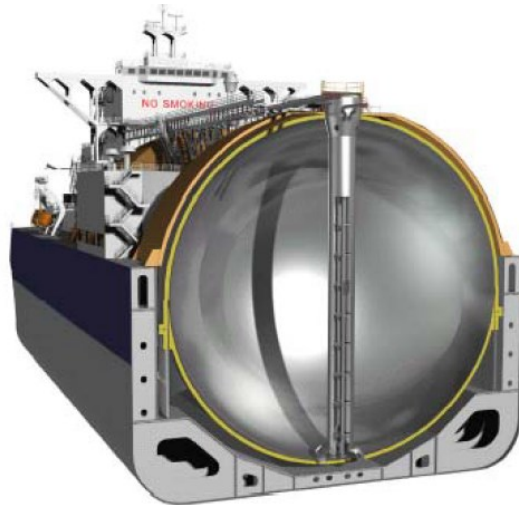

**Figure 13: B-type spherical tank**

*Source: ABS [64]*

The prismatic B-type design is an effort to merge safety with efficiency. The better space utilization allows for smaller ship dimensions and improved maneuverability. The tanks are also relatively light [65]. Main drawbacks include high cost (of approximately 10% premium over membrane), high complexity and high thermal mass [60]. Although the design received approval already in 1983 it has seldom been chosen for LNG containment - only two LNG carriers built in the early 90s and two floating storage and regasification units currently under construction [66]. Recent developments in Norway have led to a design that has been proposed for small LNG carriers [65], bunker vessels [67] and container carrier fuel tanks [68]. Their design for a container vessel fuel tank is presented in Figure 14.



**Figure 14: B-type prismatic tank 2**

*Source: NLI [65]*

#### 4.7.1.3 C-type

This is commonly regarded as the simplest and safest option for the carriage of cryogenic products. The tank is capable of withstanding multiple bars of overpressure and has very few possible leak points, unlike other tank types.

It is currently the most common choice for gas-fueled installations. The tank is offered either as double shell with vacuum or single shell with foam insulation. It can also be manufactured as bi-lobe or tri-lobe if necessary. It suffers from lower volumetric efficiency and higher weight compared to other tanks. It is commonly dimensioned for anywhere between 3 bar(g) for foam insulated designs to 10 bar(g) if using vacuum insulation. The tolerance for higher pressure allows the ship operator to bunker higher temperature LNG and utilize pressure buildup for boil-off management. Type C tanks are often chosen in order to minimize the perceived risks associated with the adoption of LNG. It is often not the most capital- or space-efficient solution.

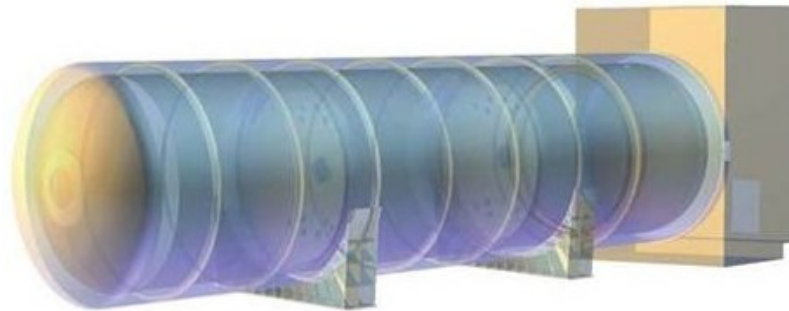

**Figure 15: C-type tank with a gas valve unit**

*Source: LNG World News [69]*

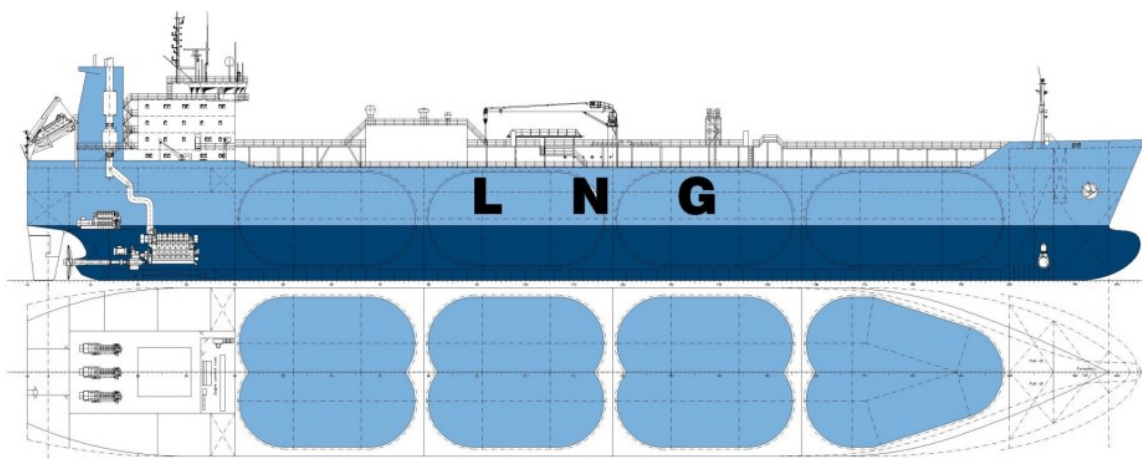

**Figure 16: C-type bi-lobe design**

*Source: TGE [70]*

#### 4.7.1.4 Membrane

Today almost all new LNG carriers feature either GT96 or Mark III Flex membrane tanks. From a technical perspective this can be explained by the more efficient use of space and lesser BOR (see Chapter 4.7.3). Both of these factors maximize the amount of cargo that reaches its destination for any fixed ship size. But should it be used for cruise ships?

Being of the integral type, the tank bottom is supported by the ship's hull. The foam insulation, by far the thickest component, is glued on top of it. The top layer, the one in direct contact with LNG, is formed of corrugated 1.2mm stainless steel.



**Figure 17: GTT membrane fuel tank**

Source: GTT [71]

The membrane tank certainly appears vulnerable but tests have shown that it allows for up to 30 cm of transverse distortion for every meter. Furthermore the manufacturer claims that sloshing is not a problem as the tank can be built with higher density foam. Though it must be noted that no significant incidents have ever occurred, all passenger vessels to date have been built with C-type tanks regardless of their higher space requirement and weight. Discussions with industry specialists indicate that the membrane-type fuel gas containment and handling system requires more initial investment but has lower operational expenditures.

#### 4.7.2 Tank arrangement

The gas fuel tank will most certainly require more space than the energy equivalent fuel oil or distillate unit. Furthermore, the tank location is severely limited by rule requirements. There are design examples of the tanks fitted above and under main deck. The former requires relatively few design changes and is a good option for conversion projects. Although reducing cargo carrying capacity, the latter remains a more common route for newbuilds.

The IGF code includes both deterministic and probabilistic tank location criteria. The former dictate that the tanks must be located within:

- $B/5$  or 11.5 m, whichever is less, from the side shell;
- $B/15$  or 2.0 m, whichever is less, from of the bottom shell plating; and
- 8% aft of the forward perpendicular for passenger ships

The probabilistic rules may allow the tank to be located closer to the side shell provided proper analysis is carried out.

If opting for pure gas engines, two tanks are required to assure redundancy of fuel supply. When using a dual-fuel engine, one tank for LNG and one for MDO would be sufficient. Discussions with a seasoned marine engineer indicated that shipowners will likely prefer designs with more than one fuel tank for redundancy considerations (current HFO-centered designs often employ three). Furthermore, if a single tank concept were to be used, a number of pillars should be removed. Such alteration would require additional steel structures to ensure structural safety.

#### 4.7.3 Boil-off

Boil-off is the quantity of liquid that changes to gas phase. Boil-off rate (BOR) is defined as additional boil-off per unit of time (most often by day). BOR is dependent on tank surface area, its heat conductivity, fuel thermodynamic state and the temperature outside of the tank. Common values for BOR are around 0.3%/day, for LNG carriers as low as 0.08%/day.

Boil-off can be handled by allowing tank pressure to increase, by liquefying the gas or burning it. Our vessel is planned to undertake up to 14-day cruises. Boil-off will thus not be a significant issue during normal operation. For safety reasons a secondary and tertiary method of gas utilization must be installed. The secondary method for a cruise ship would most likely be gas boilers which can also operate as gas combustion units. The tertiary method, one which must not be used unless absolutely necessary, is gas venting. For this reason, a vertical venting line must be installed.

#### 4.7.4 Conclusion

Many feasible designs exist for the safe carriage of LNG. The A-type design was the first but has now been superseded by the more economical B-type. The type B tanks, of which there are prismatic and spherical designs, have been utilized on LNG carriers but not as fuel tanks. These tanks are known to require higher initial expenditure but the more efficient space utilization

might prove even more valuable. The type C tank will also be considered as it is currently the industry standard for gas-fueled vessels. It offers unparalleled safety at the cost of low volumetric efficiency. The membrane tank is far less popular for fuel containment but still a feasible alternative, much like the B-type. In the following chapters B-type, C-type and membrane tank designs are considered as viable alternatives.

A comparison of LNG containment options is presented below in Table 9.

**Table 9: LNG tank comparison**

Source: adapted from [53] and [72]

IMO type	Membrane	A	B	B or C	C
<b>Tank shape</b>	Prismatic	Prismatic	Prismatic	Spherical	Cylindrical
<b>Heat insulation</b>	External	External			External   Vacuum
<b>Secondary barrier</b>	Full		Partial		None
<b>Max. pressure</b>	0.7 bar(g)			0.7 bar(g)	9 bar(g)
<b>Space efficiency</b>	High			Medium	Low
<b>Gas Delivery</b>	Pumping				Pressure buildup
<b>Weight</b>	Low			High	
<b>Design cost</b>	Medium	High		Medium	Low
<b>BOG treatment</b>	Liquefaction or combustion				Pressure increase
<b>Fuel system</b>	Complex	Complex			Simple
<b>Suitable capacity, m3</b>	>3000				<2000
<b>Operational cost</b>	High	Low			Medium

## 4.8 Regulatory framework

Gas is considered a non-traditional fuel. As such, it is subject to additional regulation. Although the requirements are not yet finalized, sufficient guidance is provided through interim guidelines and the various publications by classification societies and other regulatory bodies.

### 4.8.1 IGF code and interim guidelines

If the vessel is to sail in international waters it must meet IMO Maritime Safety Committee resolution MSC.285(86) [73] - the Interim Guidelines on Safety for Natural Gas-Fueled Engine Installations in Ships. It is currently the only IMO resolution regulating gas-fueled vessels (other than gas carriers). On January 1, 2017 it will be superseded by the IMO International Code of Safety for Ships Using Gases or Other Low Flashpoint Fuels (IGF Code) [10].

### 4.8.2 Classification society guidelines

Major class authorities (such as DNV GL [11] [15], and ABS [10] [12]) have published guidelines which can be utilized for the design of LNG machinery systems. Their recommendations are the result of consultation with the relevant regulatory bodies and can safely be used as guidance.



Published documents can provide assistance in the project planning, implementation and operation.

#### 4.8.3 USCG policy letters

In order to carry U.S. citizens as passengers, the vessel shall also meet USCG regulations. The current criteria for natural gas fuel systems design and fuel transfer has been published in the form of policy letters [8] [74] and is consistent with the IMO interim guidelines MSC.285(86). Once the IGF code is published, USCG will likely incorporate it into the existing recommendations [12].

#### 4.8.4 Design considerations

The most significant requirements concern machinery spaces and tank locations. These were already mentioned in Chapter 4.7.2.

Machinery spaces are required to follow one of two approaches – “gas-safe” or “ESD-protected”. The former aims to avoid any release of fuel gas and the latter eliminates possible sources of gas ignition. Furthermore the engines which power the vessel should be divided between two or more machinery spaces [12]. Gas-only fuel systems are required to be fully redundant. Additionally, gas piping is not permitted within 800 mm of ship side, certain hazardous areas must be separated by air locks and gas detection may be required in machinery and accommodation spaces [73].

New measures must also be put in place to ensure safe bunkering. Passengers shall not be permitted to access certain areas where fuel gas might travel and additional safety equipment must be installed [9]. A water curtain shall be created on the side of the hull to quickly evaporate any LNG spills. A stainless steel tray shall be installed beneath the bunkering connection to contain any spilled LNG and allow it to evaporate without damaging the deck.

### 4.9 Causes for concern

There is a saying that the surest way to recognize a scam is to look for opportunities offering reward with no risk. LNG has risks associated with its adoption and its best to analyze rather than avoid those. The risks discussed in this chapter concern fuel gas availability and technical issues of its utilization such as methane slip and knocking.

#### 4.9.1 Bunkering infrastructure

The primary concern for the fuel’s adoption is currently the state of bunkering infrastructure. Developing bunkering solutions for a small number of ships is prohibitively costly. According to a discussion with a U.S. LNG infrastructure developer, developing the required connection for a single cruise vessel would raise the fuel price by 50%. Such a price would put in on par with low Sulphur fuel oil (LSFO) thus destroying the economic incentive of LNG. It is evident that any adoption effort would require preexisting infrastructure, government incentives or a sufficiently large gas-fueled fleet. Incentives have played a large part in the fuel’s adoption in Europe.

Lower gas price and industry collaboration efforts are expected to play a similar role in the U.S. The first wave of bunkering stations will likely be built in ports with a gas pipeline in its proximity or at LNG import/export terminals. Worldwide locations of LNG terminals and bunkering stations have been presented in Figure 18.

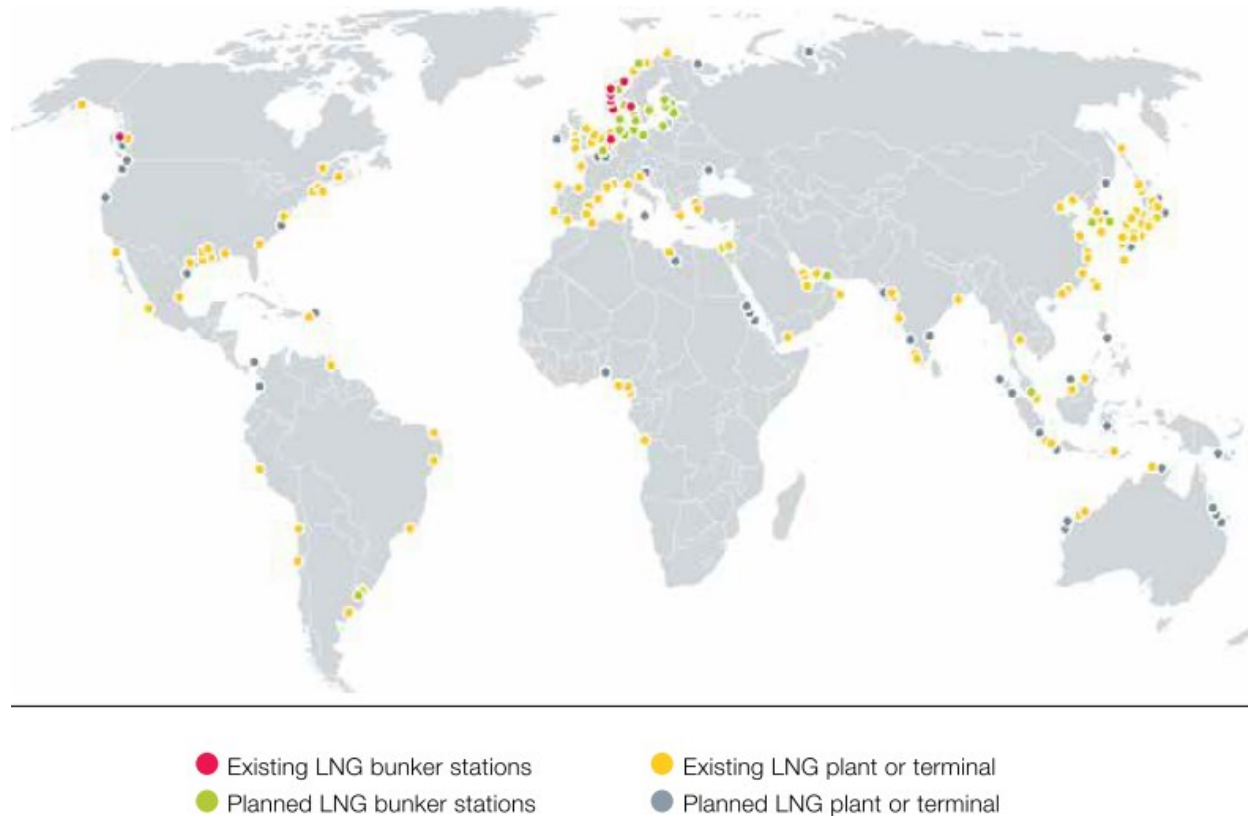

**Figure 18: LNG facilities**

*Source: adapted from [75]*

#### 4.9.2 Methane number

Methane number (MN) ranges from 0 to 100 and indicates how fast or slow a certain gas burns relative to other gases. The speed of a methane burn is used for the value 100 while hydrogen has an index value of 0. Low-pressure dual-fuel engines tend to have problems with premature combustion (knocking). This is avoided by burning only gas that is of MN 80 or above [76] [49]. Such limits further reduce the available refueling locations as only 38% of LNG produced globally fits this criterion [75].

### 4.9.3 Methane slip

According to UN Climate Council the climate change promoting effect of methane is 25 times higher than that of CO<sub>2</sub>. Even a small amount of methane escaping the ship fuel system (methane slip) has significant environmental effect [77].

The phenomenon is caused by methane and air not mixing to a sufficient extent in some combustion chamber areas such as piston rings or valve seats. There the air-fuel ratio is insufficient for combustion and some methane gets released with exhaust gases during cylinder scavenging [78]. While the 4-stroke lean-burn gas engines have methane slip of 3-5 g/kWh, dual-fuel medium speed engines exhaust roughly 6 g/kWh. Gas-diesel 2-stroke engines are the clear winners with only 0.2 to 0.5 g/kWh in any combination of diesel and gas [79]. Currently this area of engine development is undergoing intensive innovation and the current values are sure to improve.

Taking methane slip into consideration, the total hydrocarbon (THC) emission of the 2-stroke gas-diesel engine is 17-25% lower at all load levels than the diesel equivalent [79]. Dual-fuel 4-stroke engines offer up to 20% reduction at high but only 10% on low loads [80]. This reduction is illustrated in Figure 19.

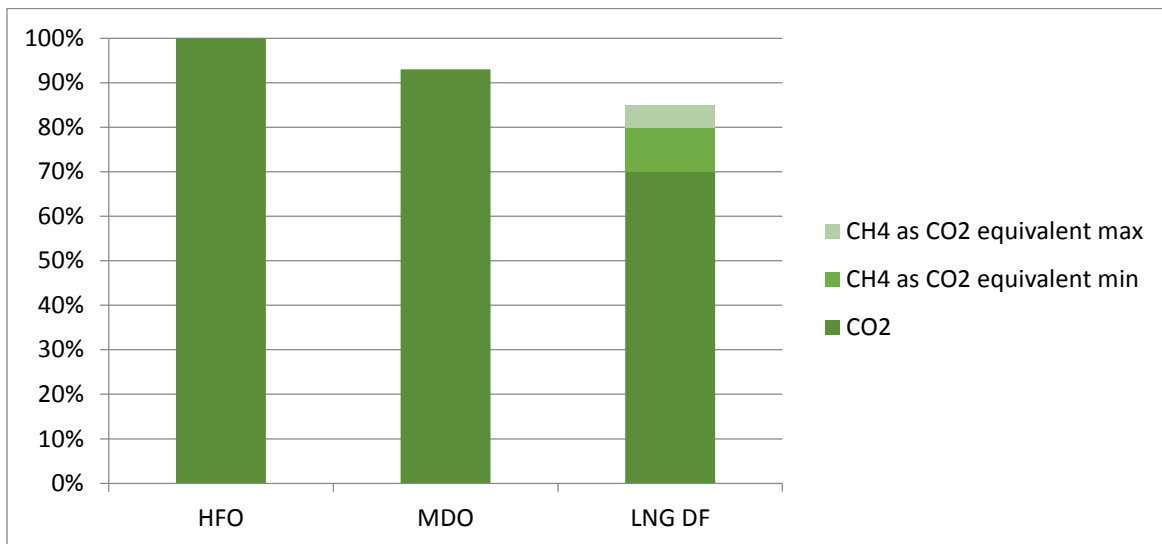
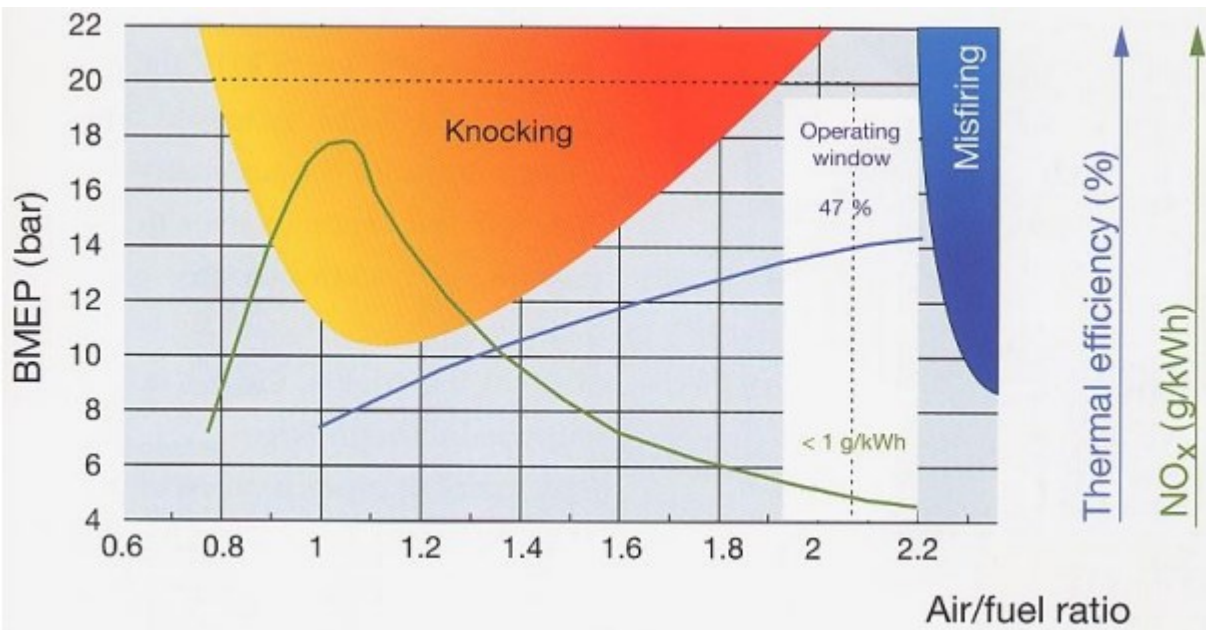

**Figure 19: THC reduction of LNG Dual Fuel**

Source: Wärtsilä [80]

### 4.9.4 Knocking

Mistimed combustion, called knocking, is a common problem for lean burn engines. It can be prevented by careful monitoring and adjusting the air-fuel ratio, the temperature and composition of fuel gas. The circumstances which bring about knocking, misfiring and change in efficiency have been demonstrated as a relationship between break mean effective pressure (BMEP) and the engine's air/fuel ratio in Figure 20.



**Figure 20: Possibility of abnormal combustion for lean burn gas engines**

*Source: adapted from [26]*

#### 4.10 Conclusion

There are four options available to meeting ECA requirements. The simplest method would perhaps be to have the ship operate in an area not affected by ECAs. This would severely damage the vessel's earning power and would only be possible until the global emissions requirements come into force.

Another operational solution would be a switch to extremely low Sulphur fuel, which is 50-70% more expensive than the currently used fuel oils [81]. In the near and medium term, this price trend is likely to hold due to fuel refining cost. This strategy is expensive but simple to adopt.

Installing SOx scrubbers is usually the economical choice for retrofit projects due to lower cost and fewer modifications compared to a switch to LNG. However using scrubbers invokes a 2% fuel penalty as well as additional maintenance and operational risks rising from added system complexity.

LNG is often the best option for newbuilds [55]. Though it suffers from high initial investment and lack of infrastructure, it does promise access to multiple fuel markets, extremely low emissions and lower overall operational costs. It is however new and untraditional. The case for this newcomer needs to be well thought out.

After considering the available technologies, three tank types and two means of power generation remain under consideration. Out of the available tank technologies, B-type, C-type

and membrane were considered suitable. Yet as we were not able to obtain a cost estimate in good time, the latter has not been included in the calculations. These fuel containment technologies are all developed and flexible. Due to their different characteristics, a more thorough economic comparison is required to determine which is most suitable for cruise ships.

As for the machines which produce useful work, combined operation gas turbines and medium speed four stroke dual fuel engines were chosen. Both these technologies are leaders between other similar solutions but comparing them against each other requires a more thorough approach.

The baseline solution, against which the abovementioned concepts are compared, is powered by a four stroke diesel engine. The fuel burned is the average 3% Sulphur HFO. The exhaust gases are rendered regulation compatible by treatment with SCR and a hybrid scrubber.

## 5 Case study

The considered machinery concepts are compared in economic terms. In the first subchapter, the vessel's characteristics are presented. This is followed by a description of the cases to be compared. The following subchapter provides more insight into the considered cost components. The chapter is finalized with an NPV calculation to determine the most profitable machinery concept or case.

### 5.1 Ship characteristics

The ship is of average size for a cruise vessel operating in the Caribbean and Mediterranean region. Main parameters presented below.

- Gross tonnage 130 000
- Length overall 315 m
- Breadth, moulded 38.4 m
- Propulsion load up to 40 MW
- Hotel load up to 17.6 MW
- Steam consumption up to 14 t/h

The ships fuel consumption was estimated over five common Caribbean and five Mediterranean cruise itineraries. For this purpose the speed-power curve of the propellers (Appendix B) were used along with the required speeds over the routes (Appendix C). It was concluded that the ship requires 50 TJ of fuel per week.

Twice per year the ship is also required to cross the Atlantic. Dimensioning the ship's LNG tanks for this route would be exceedingly uneconomical. These trips are carried out using the ship's combined reserves of MDO and LNG.

Alternative methods will be compared for covering the vessels energy requirements. In its original configuration, the ship was designed diesel-electric. Energy produced by the combustion of traditional marine fuels in medium speed engines coupled to generators. A portion of the heat from engine exhaust was utilized for steam production. More detailed steam and electric load balances can be found in relevant Appendices.

### 5.2 Cases

Five principal cases were defined and compared. Two of these are emissions regulation compliance options which do not require the use of LNG – low Sulphur fuel and exhaust gas cleaning. Three of the cases present machinery concepts centered on utilizing LNG as fuel.

### 5.2.1 Case 1: low Sulphur fuel

An abatement solution which requires minimal outlay is adopting low Sulphur fuel. By this strategy 0.1% Sulphur (0.1%S) MGO would be used in SO<sub>x</sub> ECAs (SECAs) and 0.5%S HFO in other parts of the world. The vessel also requires an SCR unit for operating in Tier III NO<sub>x</sub> ECAs (NECAs). Its initial and operational costs are considered. The cost of engines was estimated at 230 \$/kW. The methods by which the other relevant costs were obtained are presented in Chapter 5.3.

### 5.2.2 Case 2: exhaust gas cleaning

The current case has our vessel running on 3% Sulphur HFO. To adhere to ECA and Tier III requirements, the vessel employs SCR and scrubber units. These are active only while operating in emission-controlled areas.

The installation costs were determined by contacting manufacturers and consulting with a marine design company. The total cost of SCR units is estimated at \$2M and the cost of hybrid scrubbers at \$13M. The operating costs of the arrangement include urea for the SCR unit, NaOH for the scrubbers and additional fuel as well as maintenance costs due to additional machinery.

### 5.2.3 Case 3: DF + C

This option is considered the most conventional LNG concept. A set of dual-fuel engines is paired with a pressurized C-type LNG containment. The engines fulfil Tier III requirements while operating in gas mode. No scrubber would be required but SCR would still be necessary when operating in liquid fuel mode. The machinery system would still be much simpler. Exhaust waste heat would only be used to cover the ships heating demand. The tank, by outer volume, is the largest of all available options. The set of five engines is estimated to cost 290 \$/kW. The fuel gas containment and feeding system cost was estimated at 3700 \$/m<sup>3</sup>.

### 5.2.4 Case 4: DF + B

The case at hand utilizes a B-type tank design thereby saving valuable space onboard. The fuel consumption remains unchanged as the power going towards feed gas pressurization is not accounted for. The LNG containment and fuel gas feeding system price was estimated at 3700 \$/m<sup>3</sup>.

### 5.2.5 Case 5: AGT + B

This concept employs two aeroderivative gas turbines (AGT), one dual fuel reciprocating engine, a waste heat recovery turbine and the IMO B-type tank.

Gas turbines are extremely small compared to reciprocating diesel engines. The main drawback is their low efficiency (of 33-40%). The power output of a single unit is roughly 26 000 kW and efficiency 37.9 % at 25°C ambient temperature [82]. A steam turbine is utilized to produce an additional 6.4 MW of electrical power from the exhaust gas thermal energy. This can be increased up to 8MW per engine but has been capped due to temperature requirements of the SCR unit and boilers. Aeroderivative gas turbines in the 20-30 MW range cost around 430 \$/kW

[83] [84]. A major problem lies with the cost of the waste heat recovery system which would cost 2500 \$/kW [85]

Traditionally a single diesel engine is added to cover hotel loads. In this case a 13 670 kW 14-cylinder dual fuel reciprocating engine was chosen to achieve the total required 72000 kW. [86] [87]. Turbines have unfavorable efficiency at low utilization and should also be complimented by dual fuel engines. The engine cost is estimated at 290 \$/kW.

### **5.3 Cost components**

Following subchapters go into more detail as to what considerations were made in assessing the costs associated with each emission abatement scenario.

The financial costs of LNG machinery have been broken down to components contributing to CAPEX or operating expenditures (OPEX). The tanks and gas supply system as well as the additional safety measures compose majority of CAPEX. The OEPX consists of consumables – lubricants and gas, and maintenance – a net negative cost. An additional cost, one often not considered, is the income lost due to the footprint of additional machinery systems. In conducting the following calculations, all of these factors have been considered.

#### **5.3.1.1 Scrubbers**

Most likely starting 2020 [88] (or latest 2025) all ships operating globally will be required to either run on fuel which at most contains 0.5% Sulphur or use alternative means to achieve equivalent emission results [89]. In sulfur ECAs, the limit remains at 0.1%.

Compatible fuel remains expensive and scrubbers present an attractive alternative. The initial investment was estimated at \$ 13 M by a ship design engineer. The price was corroborated by consultation with a representative of a known scrubber manufacturer. According to a third party report [31], the average price of a hybrid scrubber system for our vessel would be \$ 12.7 M (including equipment, installation, engineering and training).

Scrubber adds new consumers to the electrical system and somewhat restricts the exhaust gas flow. It was found that the overall fuel consumption would increase by 0.5-1% for closed loop and by 1-2% for open loop operation [25]. In closed loop operation the system also consumes NaOH equivalent to 8% of total fuel consumption, the cost of which is estimated at 350 \$/ton [31]. As the average daily fuel consumption is 144 tons, the scrubbers require 11.52 tons or \$4000 worth. The scrubbing system must operate in a closed loop within three miles of the U.S. coastline [31]. It is assumed that the vessel spends 10% of time within this zone. The scrubber operational costs are presented in Table 10.



**Table 10: Scrubber OPEX**

		Loop	
		Open	Closed
Extra fuel	t/day	2.16	1.08
	\$/day	648	324
NaOH	t/day	-	11,52
NaOH resupply	\$/day	-	4032
Sludge	t/day	0,4	2,6
Sludge disposal	\$/day	104	766
Total	\$/day	738	5016
Op ratio	%	90 %	10 %
Weighed total	M \$/yr	0,232	0,176
<b>Grand total</b>	<b>M \$/yr</b>		<b>0,41</b>

In closed loop operation the vessel consumes 11.5 tons of NaOH and produces 2.6 tons of sludge per day. In open loop operation only 0.4 tons of sludge is produced and no NaOH is consumed. It was assumed that sludge is produced at a rate of 3.7 L/MWh and in open loop operation 0.5 L/MWh [90]. Sludge disposal costs are estimated at 290 \$/ton [90]. The total scrubber system, according to non-disclosed manufacturer information, would have a wet weight of 80 tons and occupy roughly 1500 m<sup>3</sup> of space (assuming scrubbers do not replace silencers). The yearly additional cost of scrubber operation (including NaOH purchasing, sludge disposal and additional fuel consumption) is estimated at \$ 0.41 M.

### 5.3.1.2 Selective catalytic reduction

Tier II limit for our chosen engine is 10.1 g/kWh, Tier III limit 2.5g/kWh [91] [92]. Our vessel, when burning diesel, would adhere to the global Tier II limit in any configuration. When operating in North American and Caribbean ECAs (where Tier III applies), it would be required to either run its exhaust gas through SCR or operate on gas [92].

The investment cost for the SCR arrangement has been estimated by one source [93] at \$2.0-4.1M, by another at \$0.81M (excluding installation cost) [94] and by an industry specialist at \$2.3M.

The urea consumption falls in the range of 15-20 l/MWh [93] [94] and costs 280-340 \$/ton [94]. It can be concluded that yearly urea cost falls between \$1.6-2.0M. In a different report the total operating costs are estimated at 7\$/MWh [93]. Considering the average load of 30 MW for our project, this indicates a yearly cost of \$1.76M - well in line with the previous estimate.

The space requirement of a single unit is 2.8 meters cubed and its weight 7.2 tons. One day supply of urea weights 14.4 tons. As the unit only works well within a certain temperature range (of 300-500°C), it must be installed between the turbocharger and economizer [58]. SCR

units are considered necessary for all concepts. Combined initial cost is estimated at \$2.3M and yearly cost, \$0.25M. It is assumed to be operated during 15% of total time at sea for LSFO and scrubber concepts. For gas-consuming concepts it is assumed that the device is not operated.

### 5.3.2 Exhaust gas economizers

A large portion of the energy can be retained with exhaust gas economizers. In cruise ships the hot exhaust gases are utilized to produce steam which is required for hotel and machinery consumption. Excess steam can be used to generate electricity by directing it through a turbine.

#### 5.3.2.1 Fuel costs

The cost of 0.1%S MDO and 3%S HFO was obtained from current published numbers [81]. The cost of 0.5%S HFO was estimated based on previously published price differential information [95]. The methods, by which cost of LNG was established, are presented in Chapter 3.3.2. The fuel costs are presented in Table 11.

**Table 11: Fuel cost estimates**

*Source: adapted from [81]*

Fuels	\$/t	\$/MMBtu
LNG, avg. Estimate	482	9,0
HFO, 3%S	279	6,9
MGO, 0.1%S	508	11,9
MGO, 0.5%S	336	8,1

The ship is assumed to operate 52 weeks or 354 days per year while requiring 22.5 TJ of electrical energy per week. On an average year the ship is estimated to spend 30% in SECAs and 15% in Tier III NECAs. The assumed specific energy of HFO was assumed to be 40.26 GJ/t [96], that of LNG as 53.6 GJ/t [97] and that of MGO as 42.7 GJ/t [96]. The assumed efficiencies and calculated total annual fuel costs are presented in Table 12.

**Table 12: Fuel consumption**

	Diesel	DF	AGT+ WHR	
<i>assumed efficiency</i>	45 %	45 %	42 %	
LNG		22,16	23,50	\$M/yr
3%S HFO	18,00			\$M/yr
LSMGO/LSHFO	23,60			\$M/yr

### 5.3.3 Space occupied by machinery

A cruise ship is meant to bring profit to its operator. For this purpose the amount of cabins in the vessel is usually maximized while keeping in mind some level of comfort. Removing cabins,

as we must in order to install additional equipment, decreases the value of the ship (as it can then generate less revenue). Thus a value can be assigned to an average passenger cabin (assuming the number of cabins added/removed is small). The ship berth and cabin information is obtained from the preliminary project specifications and presented in Table 13.

**Table 13: Berths and cabins**

	<b>Crew</b>	<b>Passenger</b>
Cabins	816	1818
Total area, m <sup>2</sup>	7052	30550
Avg. Area, m <sup>2</sup>	8,64	16,80
Berths, double occupancy		3636
Berths, max	1437	4447
Berths, average	-	4000
Berths per cabin	1,76	2,00
Crew berths per passenger berth	0,40	
Crew cabins per passenger cabin	0,45	

To find the value of a single square meter of cabin area, crew spaces must also be considered. The effect that a reduction in crew accommodation would have on general profitability is difficult to establish. Therefore the ration between crew cabins and passenger cabins (as well as berths) is kept constant and a reduction in crew capacity will bring about a weighted reduction in passenger capacity.

To derive the cost of a cabin, the value of the ship must first be found. This was performed by analysis of latest ships of similar size and capacity (presented in the appendix). It was obtained that the average value of a ship of this size is \$732 M.

As the areas of an average crew and passenger cabin are known, a value can be omitted to an average square meter of cabin area (presented in Table 14).

**Table 14: Value of area**

Average ship cost	732,1	\$ M
Average berth cost	0,2219	\$ M
Cost of a stateroom	0,4438	\$ M
Average value of area	0,0215	\$ M/m <sup>2</sup>

The obtained cost of 0.0215 \$M/m<sup>2</sup> will be used to evaluate the loss of revenue-generating space onboard. It will be assumed that any increase in machinery footprint will require a reduction in passenger capacity and an accompanying reduction in ship value. The footprint of

most major items was estimated based on published manufacturer information. The results are presented in Table 15.

**Table 15: Effect of machinery footprint of vessel value**

Component footprint value \$M	Cases				
	LSFO	Scrubber	DF+C	DF+B	AGT+B
SCR	-0,84	-0,84	-0,84	-0,84	-0,84
Scrubbers		-11,49			
C-type tank			-27,24		
B-type tank				-19,48	-19,48
2 AGT + 1 DF					5,69
5 diesel or DF engines	-8,43	-8,43	-8,43	-8,43	
WHR turbine					-2,39
<b>Total footprint value</b>	<b>-9,3</b>	<b>-20,8</b>	<b>-36,5</b>	<b>-28,8</b>	<b>-17,0</b>

#### 5.3.4 Other machinery items

Costs and dimensions of the main machinery items were obtained from online sources, company materials and industry partners. These have been presented in NPV comparisons.

#### 5.3.5 Combined model

The combined model aims to evaluate the considered machinery options. Their space requirement, initial and recurring costs are considered. Where possible, industry sources were used to obtain price information. In other cases information was obtained from online sources.

### 5.4 NPV comparison

The net present value method is an established tool for evaluating investment decisions [98]. The method compares cashflow from the considered investment with that resulting from an alternative yielding a constant interest rate over the entire investment period. It results in the present value for each investment indicating the profit or loss that can be expected if it is chosen. In the current investment climate it was found that 8% is a suitable interest rate. The investment will be expected to be profitable in 20 years. As we only consider costs of cruise ship machinery operation and none of the actual profits, all NPV values would be negative, just to a varying degree. Therefore, to improve readability, all NPV values have been normalized to case 1 (operating the ship on low Sulphur fuel). Any positive NPV values indicate that the considered alternative provides higher return than those of operating the ship on low Sulphur fuel.

#### 5.4.1 Initial investment and loss of space

Adequately comparing these concepts requires that we consider both the space and capital requirements as initial investments. In Figure 21, the capital costs have been presented in

lighter shade and the footprint value (or the estimated cost of revenue-generating space lost to machinery) in darker shade. The numbers are provided in Appendix E.

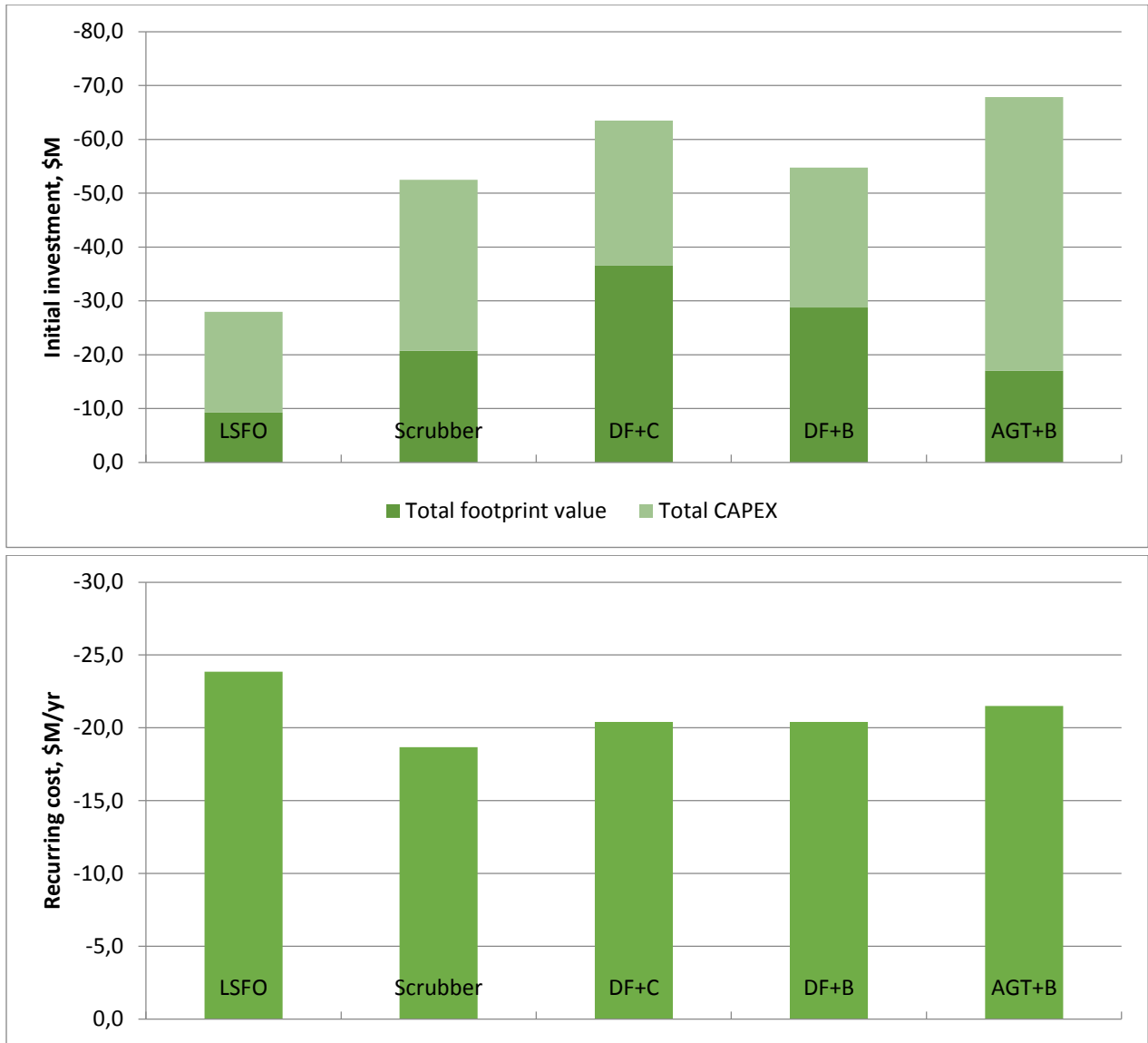

**Figure 21: Initial and recurring costs of abatement options**

Assuming HFO cost of 279 \$/t

Unsurprisingly utilizing low sulfur fuels requires the least initial outlay. Only the costs of the SCR unit and the engines were considered. The fuel tanks and other component costs were assumed to be negligible. The operational expenses of this concept, which consist almost entirely of fuel cost, are noticeably larger than the alternatives.

The total initial and operational costs of scrubber installation are close to those of LNG concepts. Whereas the scrubber would be more expensive to run, it requires less initial capital and space.

Amongst the considered LNG concepts, the dual fuel system with B-type LNG containment requires the least initial investment. Although the gas turbine does not occupy much space, it does require larger initial outlay. The operational costs of gas turbine operation were difficult to determine. Accurate information on the components was not as readily available as it is for diesel engines.

#### 5.4.2 NPV

Currently it seems that LNG is not economically the best option. The recent drop in crude prices has not been accompanied by an equally significant reduction in the price of LNG. It appears that the most reasonable LNG concept is that which applies volume-efficient fuel containment and four stroke engines. The gas turbine concept, despite being most volume efficient, has adverse operating costs and cannot be recommended. The NPV of the considered scenarios have been presented throughout the ship’s expected lifetime of 20 years (Figure 22).

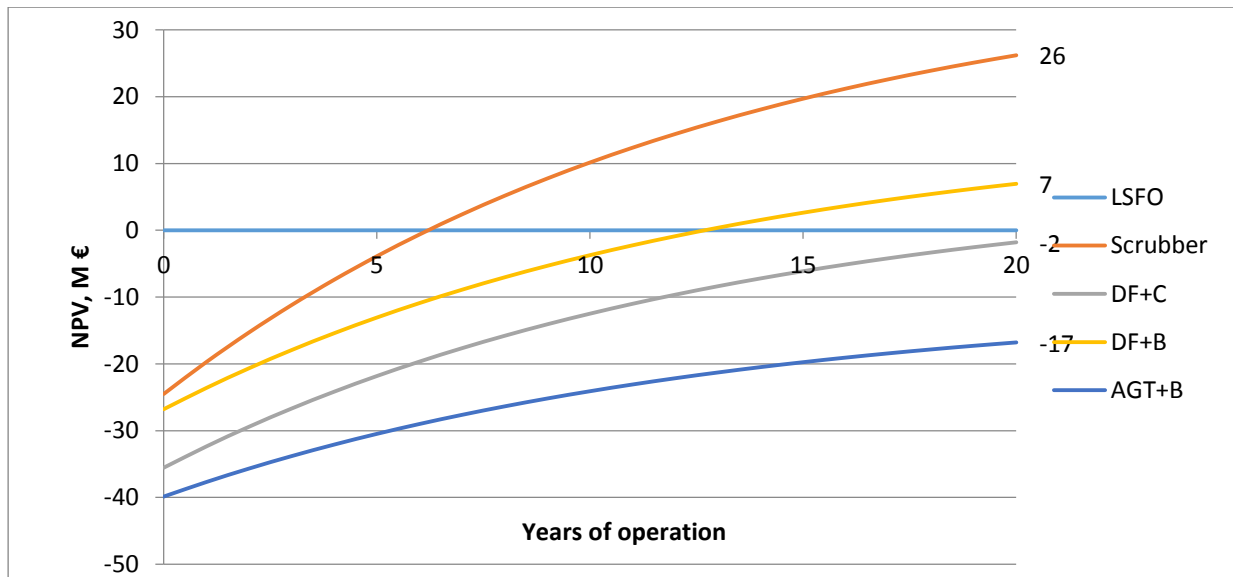

**Figure 22: Net present value comparison**

Relative to low sulfur fuel operation

Assuming that the price of crude fuels remains at current levels and no additional significant costs emerge, a new cruise ship ought to be fitted with a hybrid scrubber. This would provide 24 million dollars of profit (compared to using low Sulphur distillates) by the end of the ship’s expected 20-year life. A gas turbine operating on LNG would be financially less beneficial than

operating on low Sulphur fuel. The DF concepts employing B or C-type tanks are near equal to the base case. If there is will to build an LNG-powered vessel, the concept with dual fuel engines and B-type prismatic (or membrane) tanks should be preferred.

## 5.5 Sensitivity analysis

The purpose of this chapter is to provide insight into the fragility of the obtained results and provide a tool for decision-making were some of the major factors to undergo significant change. The effect of fuel price and ECA ratio on the NPV will be studied.

### 5.5.1 Sensitivity to fuel price

The current price of fuel is far from stable. Currently HFO price in Miami fluctuates around 280 \$/t, far cheaper than LNG at around 450 \$/t. If HFO were to cost 350\$/t, the operational costs of operating on liquid fuels would be more expensive than for LNG. This is demonstrated in Figure 23. As is to be expected, low sulfur fuel operation is by far the most expensive alternative. LNG, assuming its price remains close to 9 \$/MMBtu is then a more economical option.

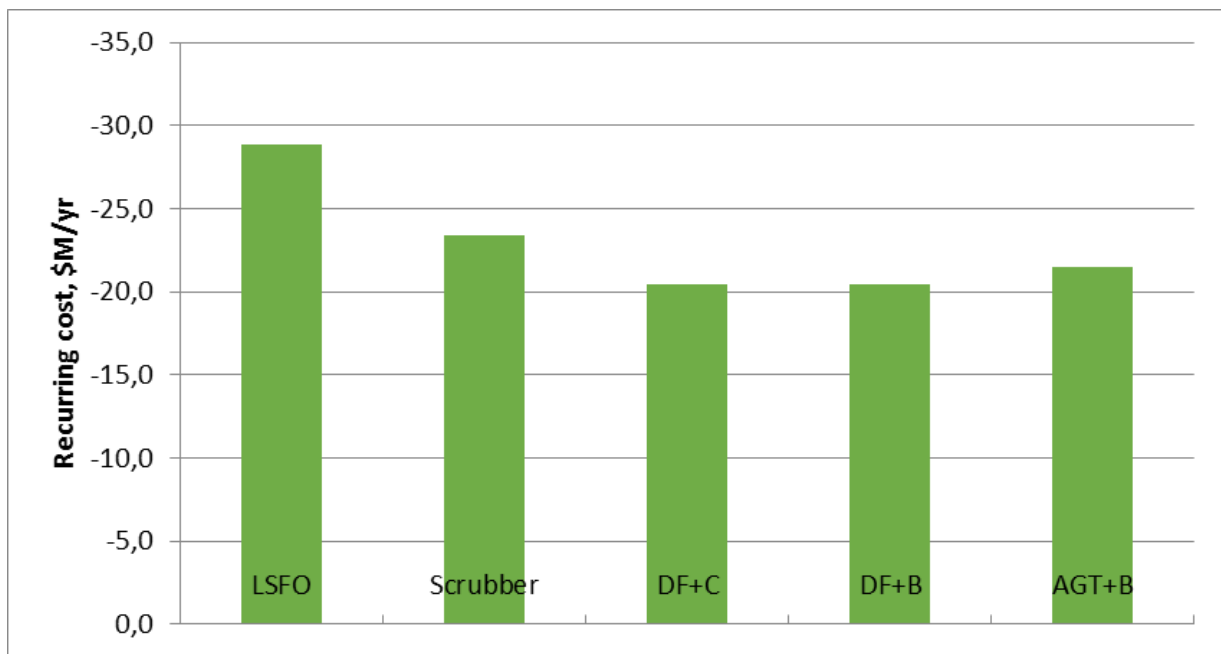

**Figure 23: Recurring costs**

Assuming HFO cost of 350 \$/t

As can be seen in Figure 24, if the cost of HFO remains above 260-290 \$/t, various LNG concepts become feasible. Scrubber remains the economical choice up to 330 \$/t. If HFO price is expected to rise and remain above that level, LNG will be the economical choice.

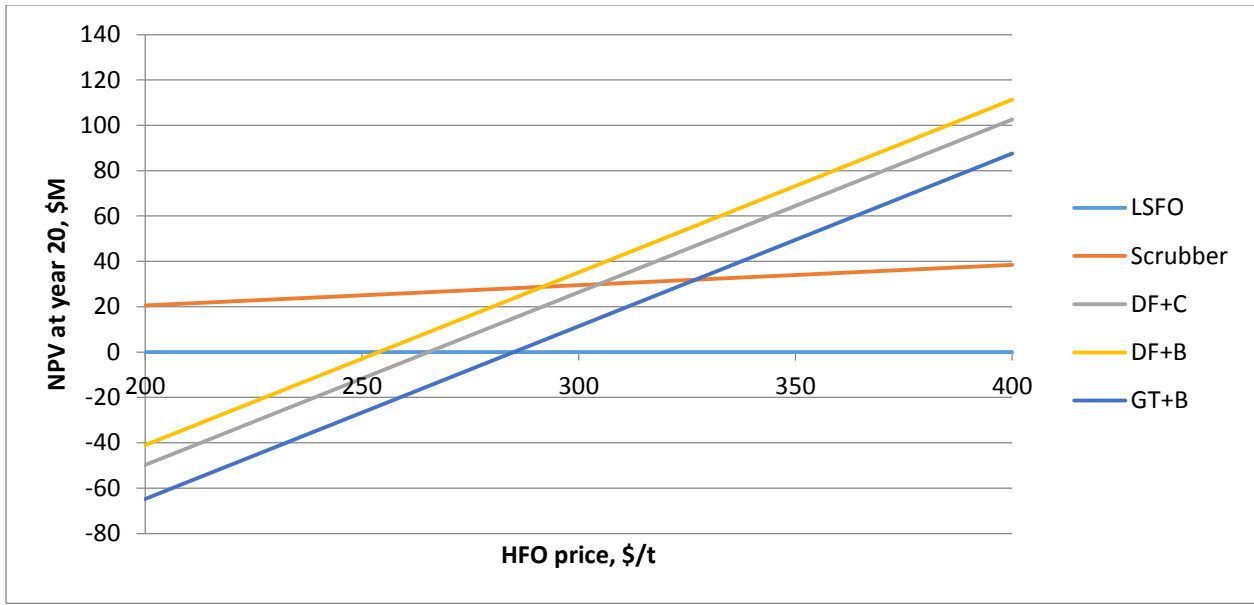

**Figure 24: NPV vs HFO price**

### 5.5.2 Sensitivity to ECA ratio

The following chart (Figure 25) assumes HFO price of 279 \$/t. As can be seen, ECA ratio has a strong effect on the profitability of these concepts. The difference in OPEX is a direct result of the cost premium of low Sulphur distillates. It can be noted that a scrubber is always a more economical option than LSFO. Various LNG concepts do not become feasible until around 50% of the itinerary lies within an ECA.

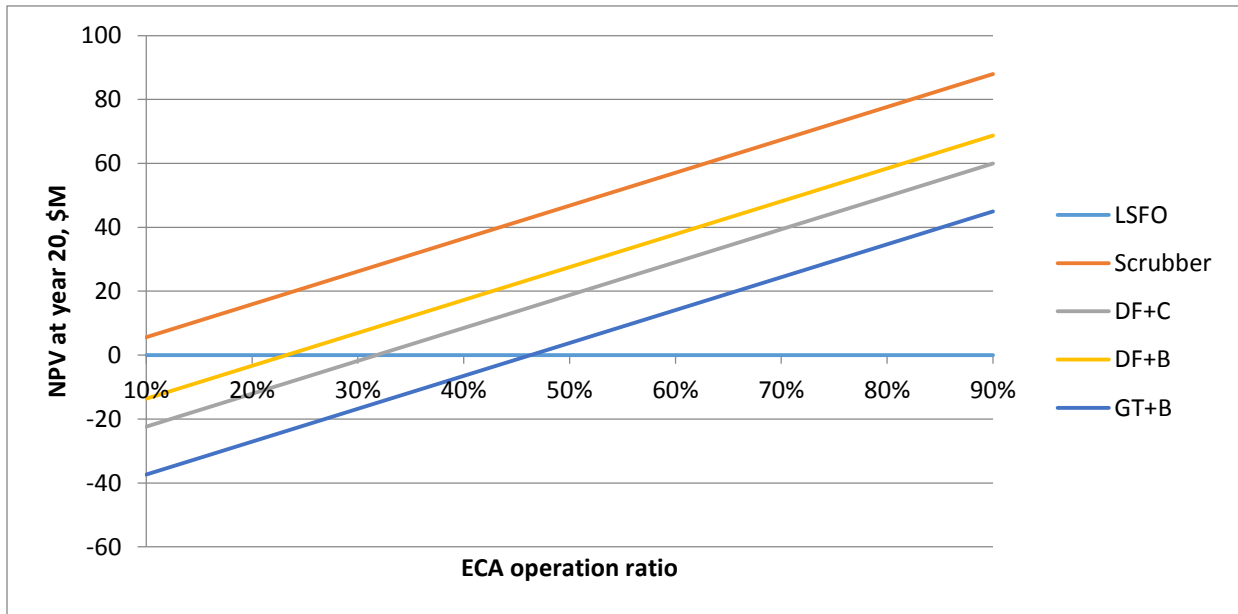
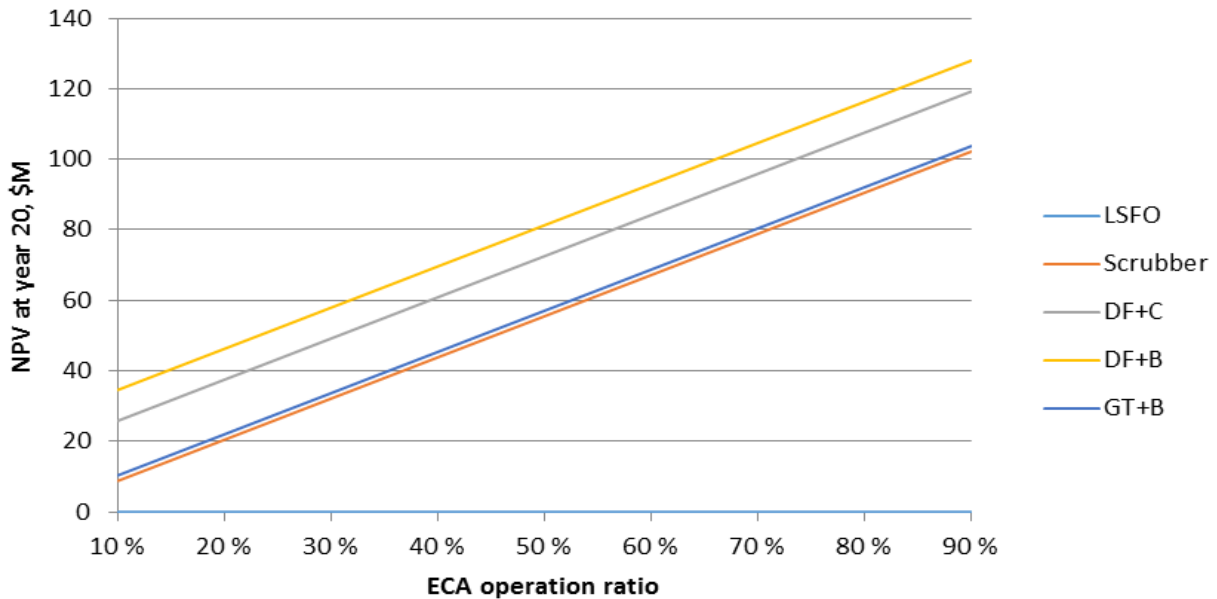

**Figure 25: NPV vs ECA ratio**

Assuming HFO cost of 250\$/t



If the cost of HFO were to rise again to 350\$/t, LNG concepts become more profitable than scrubber operation and for all ECA ratios. Assuming that our vessel spends 30% of its time in a Sulphur ECA the NPV of running the ship of natural gas for 20 years would be around \$50M and \$40M were it to be operating scrubbers. Even for just 10% ECA operation, the dual fuel as well as the scrubber concepts would be preferable to LSFO. The results have been presented in Figure 26.



**Figure 26: NPV vs ECA ratio (2)**

Assuming HFO cost of 350\$/t

### 5.5.3 Conclusion

It is clear that the economic feasibility of these concepts is rather fragile. Whereas ECAs are not likely to be abolished, fuel prices will always be difficult to estimate. With current prices, scrubbers are more economical yet only four months ago, natural gas would have been the cheaper alternative. A 25% rise in the cost of crude oil-based fuels would make all LNG-centered concepts more beneficial than scrubber operation. Under such conditions even operating entirely outside ECAs would be more economical than running on low Sulphur fuel.

## **6 Conclusion and discussion**

The research questions have been answered. The main forces driving the adoption of LNG as well as its main drawbacks were identified. Machinery concepts, which were deemed more feasible, were constructed and compared. Their benefits and drawbacks are presented in the thesis. A recommendation was made based on technical and economic and other relevant considerations.

### **6.1 Overview of research outcomes**

It can be concluded that LNG is a viable marine fuel. The recommended technologies and practices have been tried and tested in land-based power plants and on LNG carriers. There appear to be no major technological or regulatory issues. This study was conducted to identify the more fitting technologies and establish an economic case for utilizing natural gas on cruise ships.

Yet why adopt this new fuel when the industry could keep on using residual fuel oil and distillates? Firstly, LNG is often simply cheaper in the long run. Secondly it offers environmental benefits, which in turn may translate into clear economic gains through improved image and reduced taxation.

Many engine designs are currently available for utilizing LNG. Gas turbines are very space efficient but consume a much fuel. Four stroke dual fuel engines offer great operational flexibility but are not as efficient or cheap as their diesel counterparts. Unlike petroleum fuels, which can be stored with little effort, LNG requires rather complicated containment systems. Of these designs, B-type, membrane and C-type designs are most promising. The former two utilize onboard space more efficiently while the latter offers more design and operational flexibility.

As the LNG infrastructure is still developing, concepts operating only on gas are deemed too risky. All of the considered machinery concepts are thus dual fuel – capable of operating on either LNG or MGO. All LNG systems must also employ means of utilizing excess gas. The primary method is gas combustion in boilers. Provided that fails, the gas would be vented to the atmosphere.

The relative costs of the proposed solutions consist of three components – initial investment, additional space requirement and operating expenses. The former is based on information gathered from online sources and discussions with company representatives. The space requirement has been estimated based on published dimensions of main components. Recurring costs present expenditures on fuel and other consumables.

Though the current designs often prefer C-type tanks, a case can be made for the use of the more effective prismatic designs (such as membrane or B-type). Calculations, as demonstrated

in Appendix E, demonstrate that \$8-12M could be gained through the increase in passenger capacity. It is recommended that the prismatic tank be paired with dual-fuel four stroke engines. These engines are relatively cheap, efficient, of the right size, and allow for the use of both gaseous and liquid fuels.

It becomes apparent that with the current Miami HFO price of 279 \$/t, LNG is no longer economically competitive. If its price were to rise to 300-350 \$/t, LNG becomes the cheaper fuel. Such fluctuations are not uncommon and this choice is inherently risky.

## **6.2 Discussion and future considerations**

The accuracy of the study can greatly be increased by developing the proposed concepts further, creating general arrangements and adding more components to the cost analysis. Due to the high influence of fuel expenditures on the final results, small changes in plant efficiency could noticeably change the results. To this end, various hybrid solutions should also be considered.

The author felt it was necessary to include a comparison with gas turbines into the comparison as it provides insight into the value of space onboard a cruise ship. It is possible that the concept has higher operational costs than noted. The author was not able to gather sufficiently reliable information in the time allotted.

The obtained machinery costs were often unexpected. Although the contacted sources were knowledgeable, they did have incentive to provide overly optimistic values. The small differences in capital expenditures should not be fixated upon as these may easily change. For example some more complicated yet unpopular systems were offered at rather low cost. It is highly recommended that all these manufacturers be contacted again for any actual ship project.

Fuel prices are notoriously difficult to predict. It is unfortunate that it is just those prices that determine feasibility of the proposed concepts. Currently a barrel of oil costs around \$47. It has been predicted by various respected analysts that same time next year a barrel will cost either \$80, \$20 or 50\$. As these movements take place, the price of LNG has remained relatively stable. Currently only a single DF concept appears to have positive NPV and even that is around \$19M below that of the scrubber concept. If the price of crude were to rise, various intriguing concepts become profitable. Once the industry is more accustomed to alternative fuels, hybrid solutions, batteries and more exotic liquid and gaseous fuels would be tried. It is my hope that crude oil will become enormously expensive.

Dual fuel operation offers flexibility like no other concept. The shipowners now have a choice – they can remain tied to the price fluctuations of crude oil fuels or they can buy flexibility via a dual-fuel power plant. With the added safety from possible future emissions limits, dual fuel is an attractive alternative.

## 7 References

- [1] J. Cook, D. Nuccitelli, S. A. Green, M. Richardson, B. Winkler, R. Painting, R. Way, P. Jacobs and A. Skuce, "Quantifying the consensus on anthropogenic global warming in the scientific literature," *Environmental Research Letters*, vol. 8, no. 2, 2013.
- [2] OECD, "Sulphur oxides (SOx) and nitrogen oxides (NOx) emissions," 2013. [Online]. Available: <http://dx.doi.org/10.1787/9789264185715-en>. [Accessed 5 10 2015].
- [3] DNV GL, "LNG - a cost efficient fuel option?," 15 5 2014. [Online]. Available: <http://www.sjofart.ax/files/oceaneballand2014.pdf>. [Accessed 19 7 2015].
- [4] Royal Academy of Engineering, "Future Ship Powering Options," London, 2013.
- [5] R. Verbeek, N. Ligterink, J. Meulenbrugge, G. Koornneef, P. Kroon, H. de Wilde, B. Kampman, H. Croezen and S. Aarnink, "Natural gas in transport: An assessment of different routes," CE Delft, Delft, 2013.
- [6] European Maritime Safety Agency (EMSA), "Study on Standards and Rules for bunkering of gas-fuelled Ships," 2013.
- [7] Ship & Bunker News Team, "LNG Bunker Summit: Regulations, Public Opinion are the Biggest Barriers to Adopting LNG as a Marine Fuel," *Ship & Bunker*, 9 6 2014. [Online]. Available: <http://shipandbunker.com/news/features/industry-insight/485488-lng-bunker-summit-regulations-public-opinion-are-the-biggest-barriers-to-adopting-lng-as-a-marine-fuel>. [Accessed 29 4 2015].
- [8] United States Coast Guard, "Guidelines For Liquefied Natural Gas Fuel Transfer Operations and Training of Personnel on Vessels Using Natural Gas as Fuel," Washington, 2015.
- [9] USCG, "Guidance Related to Vessels and Waterfront Facilities Conducting Liquefied Natural Gas (LNG) Marine Fuel Transfer (Bunkering) Operations," Washington, 2015.
- [10] ABS, "Guide for LNG Fuel Ready Vessels," Houston, 2014.
- [11] DNV, "Being 'LNG ready' could be the best option for many ships," 15 4 2013. [Online]. Available: [http://www.dnv.com/press\\_area/press\\_releases/2013/being\\_lng\\_ready\\_could\\_be\\_the\\_best\\_option\\_for\\_many\\_ships.asp](http://www.dnv.com/press_area/press_releases/2013/being_lng_ready_could_be_the_best_option_for_many_ships.asp). [Accessed 15 5 2015].

- [12] American Bureau of Shipping, "Bunkering of Liquefied Natural Gas-fueled Marine Vessels in North America," ABS, 2015.
- [13] GL, MAN, "Costs and benefits of LNG as ship fuel for container vessels," 2011. [Online]. Available: [http://www.gl-group.com/pdf/GL\\_MAN\\_LNG\\_study\\_web.pdf](http://www.gl-group.com/pdf/GL_MAN_LNG_study_web.pdf). [Accessed 28 4 2015].
- [14] Danish Maritime Authority (DMA), "North European LNG Infrastructure Project. A feasibility study for an LNG filling station infrastructure and test of recommendations.," 2012.
- [15] DNV GL, "Liquefied Natural Gas (LNG) Bunkering Study," Det Norske Veritas (U.S.A.), Inc., 2014.
- [16] M. G. Laaveg, "Is LNG feasible as propulsion energy?," Copenhagen Business School, Copenhagen, 2013.
- [17] G. J. Jónsdóttir, "LNG as ship fuel in Iceland," Reykjavik University, Reykjavik, 2013.
- [18] DNV GL, "A Crazy Idea? Retrofitting cruise ships to LNG by elongation," DNV GL, Høvik, 2014.
- [19] G. A. Livanos, G. Theotokatos and D.-N. Pagonis, "Techno-economic investigation of alternative propulsion plants for Ferries and RoRo ships," *Energy Conversion and Management*, vol. 79, pp. 640-651, 2014.
- [20] F. Burel, R. Taccani and N. Zuliani, "Improving sustainability of maritime transport through utilization of Liquefied Natural Gas (LNG) for propulsion," *Energy*, vol. 57, pp. 412-420, 2013.
- [21] C. Christen and D. Brand, "IMO Tier 3: Gas and Dual Fuel Engines as a Clean and Efficient Solution," in *CIMAC Congress*, Shanghai, 2013.
- [22] Wärtsilä, "LNG engines: Specifications and economics," 13 10 2014. [Online]. Available: <http://www.goLNG.eu/files/Main/20141017/Rostock/LNG%20Shipping%20Session%20II%20-%20LNG%20Engines-Specifications%20and%20Economics-%20W%C3%A4rtsil%C3%A4,Ship%20Power%20-%20Hagedorn.pdf>. [Accessed 13 04 2015].
- [23] V. Smil, *Prime Movers of Globalization : The History and Impact of Diesel Engines and Gas Turbines*, MIT Press, 2010.
- [24] N. Draffin, *An Introduction to LNG Bunkering*, Petrosport, 2013.

- [25] Lloyd's Register, "Your options for emissions compliance," 2015.
- [26] ClassNK, "Development of Natural Gas Fuelled Ships," 7 2014. [Online]. Available: [http://classnk-rd.com/LNG-Fuelled\\_Vessel\\_Technologies\\_Seminar/pdf/1\\_Development\\_of\\_Natural\\_Gas\\_Fuelled\\_Ships\\_\(Natural\\_Gas\\_Engines\)\\_in\\_the\\_World.pdf](http://classnk-rd.com/LNG-Fuelled_Vessel_Technologies_Seminar/pdf/1_Development_of_Natural_Gas_Fuelled_Ships_(Natural_Gas_Engines)_in_the_World.pdf). [Accessed 28 4 2015].
- [27] IMO MEPC, "Report of The Marine Environment Protection Committee on Its Sixty-sixth Session," 2014.
- [28] International Maritime Organization, "Nitrogen Oxides (NOx) – Regulation 13," [Online]. Available: [http://www.imo.org/en/OurWork/Environment/PollutionPrevention/AirPollution/Pages/Nitrogen-oxides-\(NOx\)-%E2%80%93-Regulation-13.aspx](http://www.imo.org/en/OurWork/Environment/PollutionPrevention/AirPollution/Pages/Nitrogen-oxides-(NOx)-%E2%80%93-Regulation-13.aspx). [Accessed 22 9 2015].
- [29] United States Environmental Protection Agency, "Collaboration with Mexico to Reduce Emissions from Ships," 4 3 2015. [Online]. Available: <http://www2.epa.gov/international-cooperation/collaboration-mexico-reduce-emissions-ships>. [Accessed 12 5 2015].
- [30] DuPont, "Exhaust gas regulatory requirements for marine industry," [Online]. Available: <http://www.dupont.com/products-and-services/consulting-services-process-technologies/brands/sustainable-solutions/sub-brands/clean-technologies/products/belco-clean-air/sub-products/belco-marine-systems/belco-marine-regulatory-issues.html>. [Accessed 19 7 2015].
- [31] Glosten, "Exhaust Gas Cleaning Systems Selection Guide," Ship Operations Cooperative Program, 2015.
- [32] D. Sheppard and A. Raval, "LNG trade prepares to come out of oil's shadow," Financial Times, 28 5 2015. [Online]. Available: <http://www.ft.com/intl/cms/s/0/2ab4c50e-0539-11e5-8612-00144feabdc0.html#axzz3jLxNYJaZ>. [Accessed 20 8 2015].
- [33] Investopedia, "Henry Hub," [Online]. Available: [http://www.investopedia.com/terms/h/henry\\_hub.asp](http://www.investopedia.com/terms/h/henry_hub.asp). [Accessed 20 8 2015].
- [34] U.S. Energy Information Administration, "Natural Gas Prices," 29 5 2015. [Online]. Available: [http://www.eia.gov/dnav/ng/ng\\_pri\\_sum\\_dcu\\_nus\\_m.htm](http://www.eia.gov/dnav/ng/ng_pri_sum_dcu_nus_m.htm). [Accessed 2 6 2015].
- [35] Venture Global LNG, "Venture Global LNG sees Henry Hub-linked pricing still attractive in Asia," 15 4 2015. [Online]. Available: <http://venturegloballng.com/in-the-news/>. [Accessed 2 6 2015].

- [36] U.S. Energy Information Administration, "Florida Citygate Price," 29 5 2015. [Online]. Available: [http://www.eia.gov/dnav/ng/NG\\_PRI\\_SUM\\_DCU\\_SFL\\_M.htm](http://www.eia.gov/dnav/ng/NG_PRI_SUM_DCU_SFL_M.htm). [Accessed 2 6 2015].
- [37] Platts, McGraw Hill Financial, "Bunkerworld," [Online]. Available: <http://www.bunkerworld.com/prices/index/bwi>. [Accessed 20 8 2015].
- [38] World Bank Group, "Commodity Markets Outlook," 7 2015. [Online]. Available: [http://www.worldbank.org/content/dam/Worldbank/GEP/GEPcommodities/GEP2015c\\_commodity\\_Jul2015.pdf](http://www.worldbank.org/content/dam/Worldbank/GEP/GEPcommodities/GEP2015c_commodity_Jul2015.pdf). [Accessed 20 8 2015].
- [39] Bureau Veritas, "Prime Mover - Are there alternatives to the diesel engine?," [Online]. Available: <http://www.ship-efficiency.org/onTEAM/pdf/GAETJENS.pdf>. [Accessed 4 8 2015].
- [40] L. S. Langston, "Efficiency by the numbers," ASME Mechanical Engineering magazine, 1 7 2012. [Online]. Available: <http://memagazineblog.org/2012/07/01/efficiency-by-the-numbers/>. [Accessed 27 4 2015].
- [41] SkySails, "SkySails Marine," [Online]. Available: <http://www.skysails.info/english/skysails-marine/skysails-propulsion-for-cargo-ships/advantages/>. [Accessed 4 8 2015].
- [42] D. McCartney, "Gas Conditioning for Imported LNG," in *82nd annual GPA Convention*, San Antonio, 2002.
- [43] C. Emmer, "A Short Primer on LNG Tanks," 28 2 2012. [Online]. Available: <http://www.glmri.org/downloads/focusAreas/presentations/emmer2-2012.pdf>. [Accessed 4 5 2015].
- [44] J. L. Woodward and R. Pitbaldo, "Safety an environmental implications of LNG properties," in *LNG Risk Based Safety: Modeling and Consequence Analysis*, New Jersey, Wiley, 2010, p. 5.
- [45] DNV GL, "Cruise Update," 1 3 2015. [Online]. Available: [http://www.dnv.com.cn/Binaries/cruise%20update\\_low\\_tcm142-629087.pdf](http://www.dnv.com.cn/Binaries/cruise%20update_low_tcm142-629087.pdf). [Accessed 28 4 2015].
- [46] DNV GL, "LNG as ship fuel," 1 7 2015. [Online]. Available: <https://www.dnvgl.com/maritime/lng/ships.html>. [Accessed 6 8 2015].
- [47] GE Marine, "LM 2500+ Marine Gas Turbine," GE Marine, 2014.
- [48] C. Soares, *Gas Turbines: A Handbook of Land, Sea and Air Applications*, Butterworth

Heinemann, 1998.

- [49] ClassNK, "Development of Natural Gas Fuelled Ships (Natural Gas Engines) in the world," ClassNK, 7 2014. [Online]. Available: [http://classnk-rd.com/LNG-Fuelled\\_Vessel\\_Technologies\\_Seminar/pdf/1\\_Development\\_of\\_Natural\\_Gas\\_Fuelled\\_Ships\\_\(Natural\\_Gas\\_Engines\)\\_in\\_the\\_World.pdf](http://classnk-rd.com/LNG-Fuelled_Vessel_Technologies_Seminar/pdf/1_Development_of_Natural_Gas_Fuelled_Ships_(Natural_Gas_Engines)_in_the_World.pdf). [Accessed 28 4 2015].
- [50] DNV GL, "Technology outlook and future development of LNG as ship fuel," 27 6 2014. [Online]. Available: [www.nswweek.com/wp-content/uploads/6-Gerd-Michael-Wuersig.pdf](http://www.nswweek.com/wp-content/uploads/6-Gerd-Michael-Wuersig.pdf). [Accessed 4 8 2015].
- [51] "Activities of ClassNK: LNG Fuelled Ships," 7 2014. [Online]. Available: [http://classnk-rd.com/LNG-Fuelled\\_Vessel\\_Technologies\\_Seminar/pdf/6\\_Activities\\_of\\_ClassNK-LNG\\_Fuelled\\_Ship-.pdf](http://classnk-rd.com/LNG-Fuelled_Vessel_Technologies_Seminar/pdf/6_Activities_of_ClassNK-LNG_Fuelled_Ship-.pdf). [Accessed 28 4 2015].
- [52] Wärtsilä, "Gas Turbine for Power Generation: Introduction," [Online]. Available: <http://www.wartsila.com/energy/learning-center/technical-comparisons/gas-turbine-for-power-generation-introduction>. [Accessed 6 8 2015].
- [53] Mithubishi Heavy Industries, Ltd., "Environmentally Friendly & Superior Solution With LNG as Fuel," 7 2014. [Online]. Available: [http://classnk-rd.com/LNG-Fuelled\\_Vessel\\_Technologies\\_Seminar/pdf/5\\_Environmentally\\_Friendly\\_Superior\\_Solution\\_with\\_LNG\\_as\\_Fuel.pdf](http://classnk-rd.com/LNG-Fuelled_Vessel_Technologies_Seminar/pdf/5_Environmentally_Friendly_Superior_Solution_with_LNG_as_Fuel.pdf). [Accessed 28 4 2015].
- [54] United States Environmental Protection Agency, "No Discharge Zones by State," [Online]. Available: <http://water.epa.gov/polwaste/vwd/vsdnozone.cfm>. [Accessed 7 10 2015].
- [55] DNV GL, "BPO meeting: SECA is real now – first impressions of sulphur limits," 18 3 2015. [Online]. Available: [http://www.bpoports.com/SECA/Henning\\_Mohn.pdf](http://www.bpoports.com/SECA/Henning_Mohn.pdf). [Accessed 28 4 2015].
- [56] Alfa Laval, "Understanding Exhaust Gas Treatment Systems," [Online]. Available: [www.alfalaval.com/microsites/puresox/documents/Understanding\\_Exhaust\\_Gas\\_Treatment\\_Systems.pdf](http://www.alfalaval.com/microsites/puresox/documents/Understanding_Exhaust_Gas_Treatment_Systems.pdf). [Accessed 2 10 2015].
- [57] ABS, "Exhaust Gas Scrubber Systems: Status and Guidance," [Online]. Available: [http://ww2.eagle.org/content/dam/eagle/publications/2013/Scrubber\\_Advisory.pdf](http://ww2.eagle.org/content/dam/eagle/publications/2013/Scrubber_Advisory.pdf). [Accessed 2 10 2015].
- [58] D.E.C. Marine AB, "WP3 - Exhaust Gas Cleaning," EffShip, Gothenburg, 2013.
- [59] Man Diesel & Turbo, "Alternate Fueled Engine Development and Experience," Copenhagen, 2015.



- [60] J. Evangelista, "Tank support for the LNG revolution," Offshore Engineer Digital, 17 2014. [Online]. Available: <http://www.oedigital.com/energy/lng/item/6276-tank-support-for-the-lng-revolution>. [Accessed 28 4 2015].
- [61] Torgy AS, "LNG Client Presentation," [Online]. Available: <http://www.torgy.no/component/k2/lng-1?Itemid=141>. [Accessed 19 2015].
- [62] DNV, "LNG fuel tank - benefits and challenges," 2013. [Online]. Available: <http://www.lngbunkering.org/sites/default/files/2013%20DNV%20LNG%20fuel%20tank%20%E2%80%93%20benefits%20and%20challenges.pdf>. [Accessed 13 10 2015].
- [63] M. D. Tusiani and G. Shearer, "LNG: a nontechnical guide," Tulsa, PennWell Corporation, 2007, pp. 139-143.
- [64] W. J. Sember, "State of The LNG Industry: A Class Perspective," 30 9 2005. [Online]. Available: [www.aimu.org/aimupapers/Sember.pdf](http://www.aimu.org/aimupapers/Sember.pdf). [Accessed 19 2015].
- [65] NLI, "NLI TS-X (TM)," [Online]. Available: <http://www.nli.no/index.php?parent=151&groupid=2303>. [Accessed 9 9 2015].
- [66] A. Abe, "IHI Corporation - Activities for Offshore Development in Brazil," 9 9 2014. [Online]. Available: [https://www.google.fi/url?sa=t&rct=j&q=&esrc=s&source=web&cd=6&ved=0CEUQFjAFa hUKEwjtu6L9utPHAhVGkSwKHUHmC70&url=http%3A%2F%2Farquivos.portaldaindustria.com.br%2Fapp%2Fconteudo\\_13%2F2014%2F08%2F06%2F840%2FAkinoriAbe-IHI.pdf&ei=l1vkVa2eF8aisgHBzK\\_oCw&usg=AF](https://www.google.fi/url?sa=t&rct=j&q=&esrc=s&source=web&cd=6&ved=0CEUQFjAFa hUKEwjtu6L9utPHAhVGkSwKHUHmC70&url=http%3A%2F%2Farquivos.portaldaindustria.com.br%2Fapp%2Fconteudo_13%2F2014%2F08%2F06%2F840%2FAkinoriAbe-IHI.pdf&ei=l1vkVa2eF8aisgHBzK_oCw&usg=AF). [Accessed 31 8 2015].
- [67] World Maritime News, "NLI Develops Design Concept for LNG Bunker Barge," 5 5 2013. [Online]. Available: <http://worldmaritimeneews.com/archives/116582/nli-develops-design-concept-for-lng-bunker-berge/>. [Accessed 9 9 2015].
- [68] World Maritime News, "NLI Offshore Teams Up with HHI," 8 12 2014. [Online]. Available: <http://worldmaritimeneews.com/archives/146307/nli-offshore-teams-up-with-hhi/>. [Accessed 9 9 2015].
- [69] LNG World News, "INOXCVA Gets LNG Storage Tanks Deal," 8 5 2014. [Online]. Available: <http://www.lngworldnews.com/inoxcva-gets-lng-storage-tanks-deal/>. [Accessed 19 2015].
- [70] TGE Marine Gas Engineering, "New Generation of Modern Small LNG Carriers and ReGas Barges for the Chinese Market," 2014. [Online]. Available: [http://www.tge-marine.com/files/small\\_scale\\_lng\\_june\\_2014\\_stavanger.pdf](http://www.tge-marine.com/files/small_scale_lng_june_2014_stavanger.pdf). [Accessed 22 9 2015].

- [71] Gaztransport et Technigaz, "Mediacenter," [Online]. Available: <http://www.gtt.fr/mediacenter/brochures/>. [Accessed 19 2015].
- [72] World Ports Climate Initiative, "Tank types," 2013. [Online]. Available: <http://www.lngbunkering.org/lng/technical-solutions/tank-types>. [Accessed 13 8 2015].
- [73] International Maritime Organization, "Resolution MSC.285(86) - Interim Guidelines on Safety for Natural Gas-fuelled Engine Installations in Ships," 2009.
- [74] United States Coast Guard, "Equivalency Determination: Design Criteria for Natural Gas Fuel Systems," 2012.
- [75] MAN Diesel & Turbo, "MAN B&W Dual Fuel Engines - Starting a New Era in Shipping," Copenhagen, 2014.
- [76] Clarke Energy, "Methane Number," 20 6 2012. [Online]. Available: <http://www.clarke-energy.com/2012/methane-number/>. [Accessed 4 5 2015].
- [77] United Nations, "Global Warming Potentials," [Online]. Available: [http://unfccc.int/ghg\\_data/items/3825.php](http://unfccc.int/ghg_data/items/3825.php). [Accessed 28 4 2015].
- [78] P. Pospiech, "Is Internal Combustion Engine Methane Slip Harmful to the Environment?," MarineLink, 21 4 2014. [Online]. Available: <http://www.marinelink.com/news/combustion-internal367472.aspx>. [Accessed 28 4 2015].
- [79] MAN Diesel & Turbo, "Gas 2-stroke marine engine design and operation," 1 2015. [Online]. Available: [www.lme.ntua.gr:8080/whats-new/news-1/02\\_NKj.pdf](http://www.lme.ntua.gr:8080/whats-new/news-1/02_NKj.pdf). [Accessed 19 2015].
- [80] Wärtsilä, "Gas engine emissions - Wärtsilä Dual Fuel," 16 12 2013. [Online]. Available: [http://www.lng-nordwest.de/files/lng\\_downloads/WS\\_131216/20131216%20Wartsila%20Leer\\_DF%20emission%20conference.pdf](http://www.lng-nordwest.de/files/lng_downloads/WS_131216/20131216%20Wartsila%20Leer_DF%20emission%20conference.pdf). [Accessed 19 2015].
- [81] Bunkerworld, [Online]. Available: <http://www.bunkerworld.com/prices/>. [Accessed 29 4 2015].
- [82] MTU Maintenance, "LM2500+ DLE Package for sale," 2015. [Online]. Available: [http://powersolutions.mtu.de/fileadmin/DE/MTU\\_POWER\\_SOLUTIONS/Equipment\\_Parts/Used\\_Power\\_Plants/Products/LM2500\\_Package\\_For\\_Sale.pdf](http://powersolutions.mtu.de/fileadmin/DE/MTU_POWER_SOLUTIONS/Equipment_Parts/Used_Power_Plants/Products/LM2500_Package_For_Sale.pdf). [Accessed 13 10 2015].
- [83] Nye Thermodynamics Corporation, "Gas Turbine Prices \$ per KW," [Online]. Available:

- <http://www.gas-turbines.com/trader/kwprice.htm>. [Accessed 14 9 2015].
- [84] M. P. Boyce, "Gas Turbine Size and Efficiency," in *Gas Turbine Engineering Handbook*, Elsevier, 2012, p. 180.
- [85] Mid-Atlantic CHP Technical Assistance Partnership, "Waste Heat to Power Technologies," [Online]. Available: [http://www.midatlanticchptap.org/cleanenergy\\_whr\\_heat-to-power.html](http://www.midatlanticchptap.org/cleanenergy_whr_heat-to-power.html). [Accessed 14 9 2015].
- [86] Toshiba Mitsubishi Electric Industrial Systems Corporation, "Waste Heat Recovery Power Generator," [Online]. Available: [www.gaselectricpartnership.com/GTMEIC.pdf](http://www.gaselectricpartnership.com/GTMEIC.pdf). [Accessed 14 9 2015].
- [87] Energy and Environmental Analysis, Inc., "Waste Energy Recovery Opportunities for Interstate Natural Gas Pipelines," 2 2008. [Online]. Available: [www.ingaa.org/file.aspx?id=6210](http://www.ingaa.org/file.aspx?id=6210). [Accessed 14 9 2015].
- [88] "ICS: Prepare for Global Sulfur Cap in 2020," *The Maritime Executive*, 6 2 2015. [Online]. Available: <http://www.maritime-executive.com/article/ics-prepare-for-global-sulphur-cap-in-2020>. [Accessed 8 9 2015].
- [89] International Maritime Organization, "Prevention of Air Pollution from Ships," [Online]. Available: <http://www.imo.org/en/OurWork/Environment/PollutionPrevention/AirPollution/Pages/Air-Pollution.aspx>. [Accessed 8 9 2015].
- [90] Wärtsilä OY, "A Glance at CAPEX & OPEX for Compliance with Forthcoming Environmental Regulations," 2014. [Online]. Available: <https://www.marinemoney.com/sites/all/themes/marinemoney/forums/GR14/presentations/1220%20Tomas%20Aminoff.pdf>. [Accessed 2 10 2015].
- [91] International Maritime Organization, "Nitrogen Oxides (NOx) - Regulation 13," [Online]. Available: [http://www.imo.org/en/OurWork/Environment/PollutionPrevention/AirPollution/Pages/Nitrogen-oxides-\(NOx\)-%E2%80%93-Regulation-13.aspx](http://www.imo.org/en/OurWork/Environment/PollutionPrevention/AirPollution/Pages/Nitrogen-oxides-(NOx)-%E2%80%93-Regulation-13.aspx). [Accessed 8 9 2015].
- [92] Wärtsilä, "Wärtsilä 46F Product Guide," Wärtsilä Finland OY, Vaasa, 2014.
- [93] Wärtsilä, "Wärtsilä Low NOx Solutions," 14 5 2008. [Online]. Available: <http://blueoceansoln.com/wp-content/uploads/2012/12/W%C3%A4rtsil%C3%A4-Wet-Package-2008-1.pdf>. [Accessed 8 9 2015].
- [94] Wilhelmsen Technical Solutions, "SCR - walking the talk," [Online]. Available:

[www.baltic.org/files/1893/BSR\\_InnoShip\\_Turku.pdf](http://www.baltic.org/files/1893/BSR_InnoShip_Turku.pdf). [Accessed 8 9 2015].

- [95] J. Kalli and T. Karvonen, "Sulphur content in ships bunker fuel in 2015. A study on the impacts of new IMO regulation and transportation costs.," Ministry of Transport and Communications Finland, Helsinki, 2009.
- [96] CIMAC, "Guideline for the Operation of Marine Engines on Low Sulphur Diesel," 2013. [Online]. Available: [http://www.cimac.com/cms/upload/workinggroups/WG7/CIMAC\\_SG1\\_Guideline\\_Low\\_Sulphur\\_Diesel.pdf](http://www.cimac.com/cms/upload/workinggroups/WG7/CIMAC_SG1_Guideline_Low_Sulphur_Diesel.pdf). [Accessed 14 10 2015].
- [97] Australian Gas Networks, "About Natural Gas - Reference Guides," [Online]. Available: <http://www.natural-gas.com.au/about/references.html>. [Accessed 14 10 2015].
- [98] M. Stopford, Maritime Economics, London: Routledge, 2003.
- [99] MarineLog, "GE and LR look for gas turbine commercial ship opportunities," 23 7 2014. [Online]. Available: [http://www.marinelog.com/index.php?option=com\\_k2&view=item&id=7039:ge-and-lr-look-for-commercial-ship-opportunities-for-gas-turbines&Itemid=231](http://www.marinelog.com/index.php?option=com_k2&view=item&id=7039:ge-and-lr-look-for-commercial-ship-opportunities-for-gas-turbines&Itemid=231). [Accessed 27 4 2015].

## **8 List of appendices**

Appendix A: Steam balance

Appendix B: Speed-power curve

Appendix C: Fuel consumption by itinerary

Appendix D: Similar vessels

Appendix E: Initial and recurring costs

# Appendix A

## Steam balance

	units	Summer Harbour	Summer sea 15kn	Summer sea 22,5kn	Winter harbour	Winter sea 15kn	Winter Sea 22,5kn
<b>Main generators</b>							
Propulsion power	kW	0	11000	40000	0	11000	40000
Hotel load	kW	11134	13922	13922	8595	11383	11383
Ps	kW	11419	26235	57757	8815	23631	55153
no. of engines running		1	2	5	1	2	5
Condition		TROPIC	TROPIC	TROPIC	ISO	ISO	ISO
Engine load	%MCR	79	91	80	61	82	77
<b>Heat consumption</b>							
	kWh/t		144	144		144	144
Evaporator 1	kW	0	4200	4200	0	4200	4200
	kWh/t		144	144		144	144
Evaporator 2	kW	0	4200	4200	0	4200	4200
	W/m3	181	269	269	300	369	369
HFO Tank Heating	kW	650	970	970	1080	1330	1330
	kW/kW *	6	6	6	6	6	6
FO&LO equipment	kW	660	1340	1650	700	1440	1780
	kg/h	0	0	0	0	0	0
EGE Shoot removers***	kW	0	0	0	0	0	0
	W/GT	18	18	18	36	36	36
AC	kW	2400	2400	2400	4800	4800	4800
	W/GT	8,5	8,5	8,5	10,0	10,0	10,0
Potable water	kW	1150	1150	1150	1350	1350	1350
	kW/m3	2,3	2,3	2,3	5,7	5,7	5,7
Swimming pools	kW	710	710	710	1770	1770	1770
	W/GT	7,6	7,6	7,6	7,6	7,6	7,6
Galley	kW	1030	1030	1030	1030	1030	1030
	W/GT	7,6	7,6	7,6	7,6	7,6	7,6
Laundry	kW	1030	1030	1030	1030	1030	1030
Total consumption	kW	7630	17030	17340	11760	21150	21490
<b>Heat Recovery</b>							
HT- water flow	m3/h	277	285	278	260	266	263
HT- water recirculation	m3/h	80	74	80	100	80	82
HT- water out temperature	DegC	91,5	93	92	87	91	90

HT- water in temperature	DegC	78	78	78	78	78	78
Heat recovery / ME	kW	3088	3675	3219	1672	2808	2522
Heat recovery for FWE	kW	0	7350	8400	0	5615	8400
Heat recovery for AC Reheating	kW	2400	0	2400	1672	0	4210

**Additional heat**

Heating power	kW	5230	9680	6540	10088	15535	8880
Steam	kg/h	8180	15140	10229	15778	24297	13889

**Steam production**

Oil Fired Boilers	kg/h	5530	8740	0	13928	19597	2639
Exhaust Gas Economizers	kg/h	2650	6400	13400	1850	4700	11250
Surplus condenser	kg/h	0	0	3171	0	0	0
no. of oil fired boilers running**		1	1	0	1	2	1
Oil fired boiler load	%	0,37	0,58	0,00	0,93	0,65	0,18

\*Basic load + 6 kW/kW

\*\*Two (2) boilers each 15 000 kg/h

\*\*\*No continuous consumption, depends of type of the shoot remover (automatic or manual) and EGE manufacturer

## Appendix B

Speed-power curve

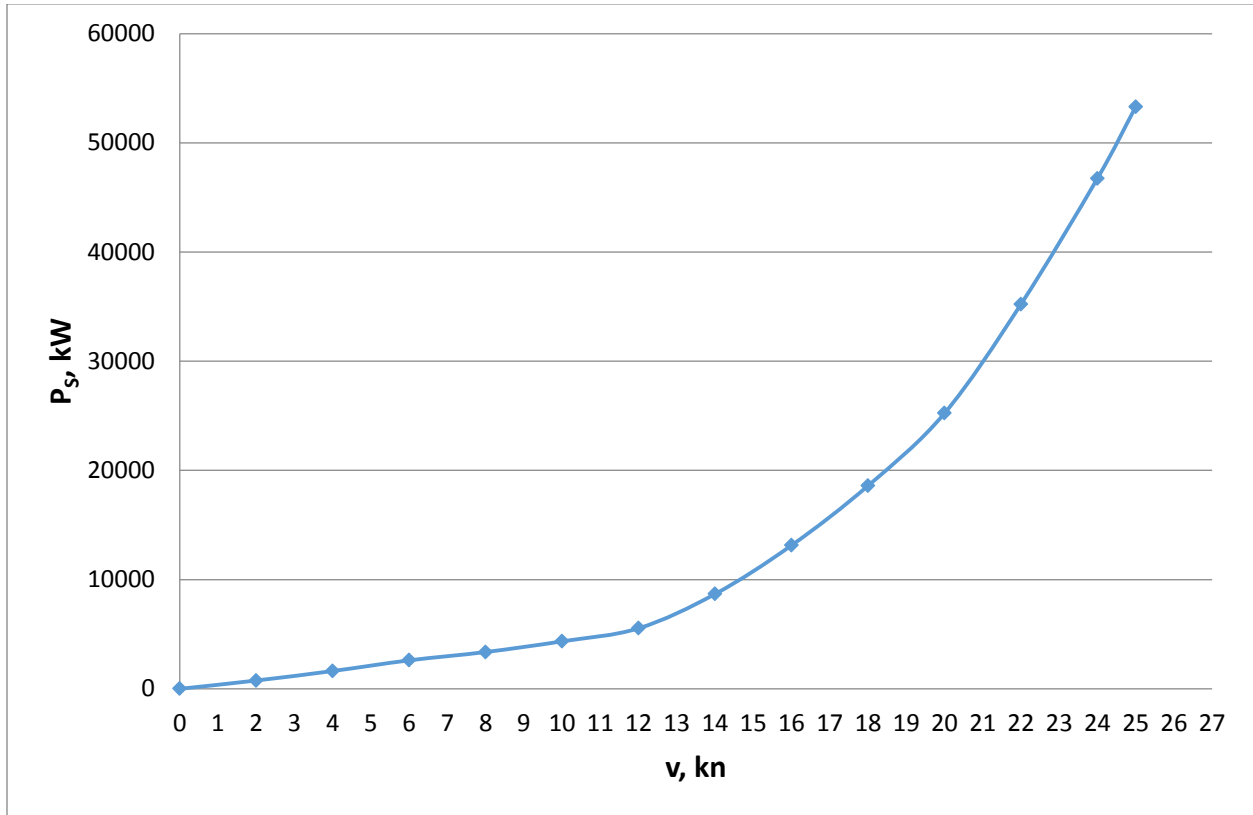

Assumed AC-to-propeller efficiency of the azimuthing electrical propulsion unit is 92%.

v, kn	Ps, kW	Pd, kW
0	0	0
2	700	761
4	1500	1630
6	2400	2609
8	3100	3370
10	4000	4348
12	5099	5542
14	7987	8682
16	12087	13138
18	17109	18597
20	23213	25232
22	33591	36512
24	41787	45421
25	49026	53289



# Appendix C

Fuel consumption by itinerary

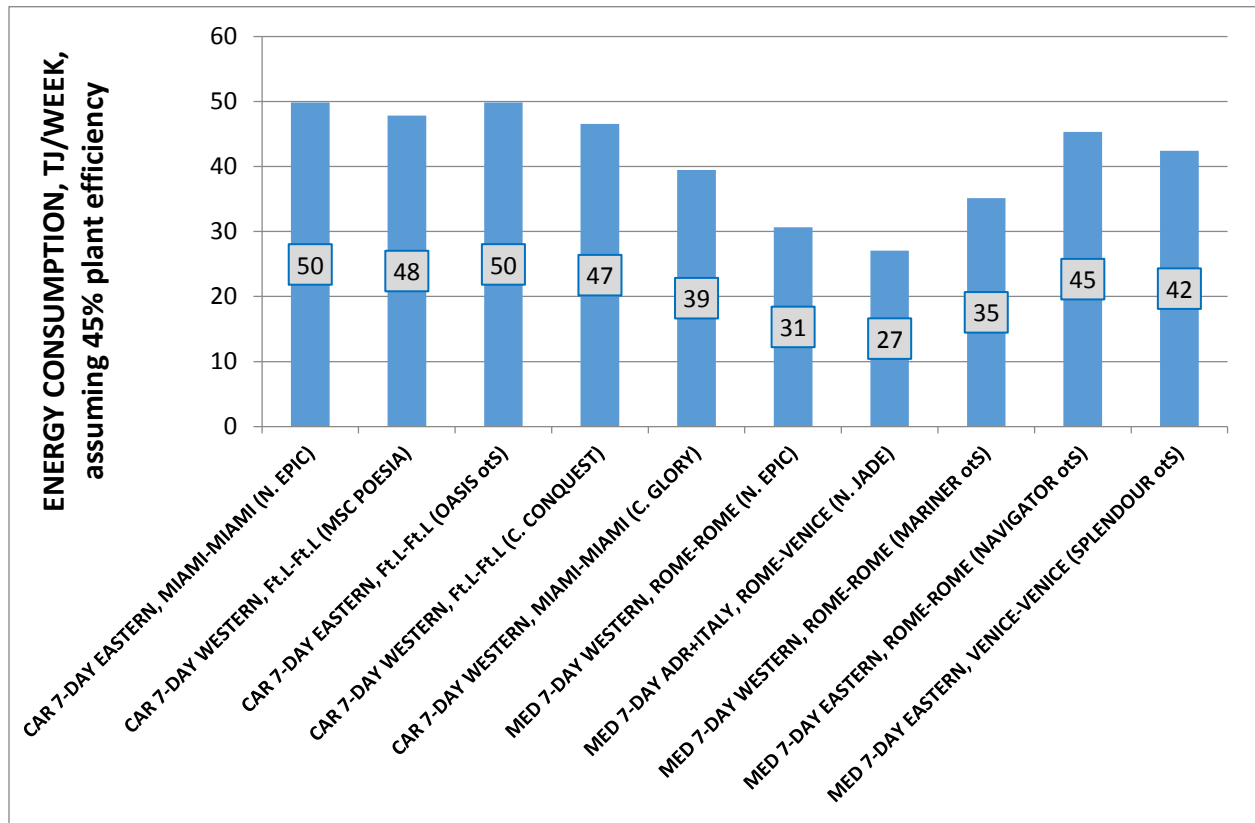

## Appendix D

### Similar vessels

Ship's name	Cruise line operator	Gross tonnage	Pax. d.o.	Price, (M\$)	P/C
Costa Fascinosa	Costa Crociere	114,5	3012	726	0,241
Celebrity Reflection	Celebrity Cruises	122	2850	768	0,269
Royal Princess	Princess Cruises	139	3600	735	0,204
MSC Divina	MSC Cruises	140	3502	742	0,212
Norwegian Breakaway	NCL	143,5	4000	840	0,210
Carnival Dream	CCL	130	3652	668	0,183
Celebrity Equinox	Celebrity Cruises	122	2850	641	0,225
MSC Splendida	MSC Cruises	133,5	3887	550	0,141
TBA	NCL	150	4200	863	0,205
Celebrity Eclipse	Celebrity Cruises	122	2850	641	0,225
TBA	NCL	150	4200	940	0,224
TBA	P&O Cruises	116	3110	615	0,198
Carnival Magic	CCL	130	3652	668	0,183
TBA	Celebrity Cruises	122	2850	641	0,225
TBA	Disney Cruise Line	124	2500	500	0,200
TBA	Disney Cruise Line	124	2500	500	0,200
<b>Average</b>		<b>130</b>	<b>3326</b>	<b>690</b>	<b>0,209</b>

<b>Ship's name</b>	<b>Cruise line operator</b>	<b>Gross tonnage</b>	<b>Cabins</b>	<b>Capacity</b>	<b>Max. capacity</b>
Navigator of the Seas	Royal Caribbean International	140 000	1638	3276	3807
MSC Divina	MSC Cruises	140 000	1739	3478	3900
MSC Preziosa	MSC Cruises	140 000	1739	3478	3959
Mariner of the Seas	Royal Caribbean International	139 000	1557	3114	3807
Explorer of the Seas	Royal Caribbean International	139 000	1557	3114	3840
Voyager of the Seas	Royal Caribbean International	139 000	1557	3114	3840
MSC Fantasia	MSC Cruises	138 000	1637	3274	3900
MSC Splendida	MSC Cruises	138 000	1637	3274	3900
Adventure of the Seas	Royal Caribbean International	137 000	1557	3114	3807
Carnival Dream	Carnival Cruise Lines	130 000	1823	3646	4631
Carnival Magic	Carnival Cruise Lines	130 000	1845	3690	4720
Carnival Breeze	Carnival Cruise Lines	130 000	1845	3690	4720
Disney Dream	Disney Cruise Line	130 000	1250	2500	4000
Disney Fantasy	Disney Cruise Line	130 000	1250	2500	4000
Celebrity Reflection	Celebrity Cruises	125 000	1523	3046	3480
Celebrity Silhouette	Celebrity Cruises	122 000	1443	2886	3320
Celebrity Solstice	Celebrity Cruises	122 000	1426	2852	3148
Celebrity Equinox	Celebrity Cruises	122 000	1426	2852	3148
Celebrity Eclipse	Celebrity Cruises	122 000	1426	2852	3148
<b>Average</b>		<b>132000</b>	<b>1572</b>	<b>3145</b>	<b>3846</b>

## Appendix E

### Initial and recurring costs

Component footprint value \$M	Cases				
	LSFO	Scrubber	DF+C	DF+B	AGT+B
SCR	-0,84	-0,84	-0,84	-0,84	-0,84
Scrubbers		-11,49			
C-type tank			27,24		
B-type tank				19,48	-19,48
2 AGT + 1 DF					5,69
5 diesel or DF engines	-8,43	-8,43	-8,43	-8,43	
WHR turbine					-2,39
<b>Total footprint value</b>	<b>-9,3</b>	<b>-20,8</b>	<b>-36,5</b>	<b>-28,8</b>	<b>-17,0</b>

CAPEX, \$M	Cases				
	LSFO	Scrubber	DF+C	DF+B	AGT+B
SCR	-2,30	-2,30			
Scrubbers		-13,00			
5 diesel engines	16,40	-16,40			
5 DF engines			17,50	17,50	
C-type tanks			-9,50		
B-type tank				-8,50	-8,50
2 AGT + 1 DF					-26,30
WHR turbine					-16,00
<b>Total CAPEX</b>	<b>-18,7</b>	<b>-31,7</b>	<b>-27,0</b>	<b>-26,0</b>	<b>-50,8</b>

OPEX, \$M	Cases				
	LSFO	Scrubber	DF+C	DF+B	AGT+B
Cost of fuel	23,60	-18,00	22,16	22,16	-23,50
Reduced maintenance			1,75	1,75	2,00
Scrubber operation		-0,43			
SCR operation	-0,25	-0,25			
<b>Total OPEX</b>	<b>-23,8</b>	<b>-18,7</b>	<b>-20,4</b>	<b>-20,4</b>	<b>-21,5</b>